

DJSF1352-RN 导轨式直流电能表
DJSF1352-RN rail-mounted DC power meter

安装使用说明书 V1.8
Installation and Operation Instruction V1.8

安科瑞电气股份有限公司

ACREL CO., Ltd.

2019.01

申 明

版权所有，未经本公司之书面许可，此手册中任何段落、章节内容均不得被摘抄、拷贝或以任何形式复制、传播，否则一切后果由违者自负。

本公司保留一切法律权利。

本公司保留对本手册所描述之产品规格进行修改的权利，恕不另行通知。订货前，请垂询当地代理商以获悉本产品的最新规格。

DECLARATION

No part of this publication may be reproduced, stored in a retrieval system, or transmitted in any form by any means, electronic, mechanical photocopying, recording, or otherwise without prior permission of Acrel. All rights reserved.

This company reserve power of revision of product specification described in this manual, without notice. Before ordering, please consult local agent for the latest specification of product.

目录

CONTENTS

目录.....	2
1 概述 Overview.....	1
2 产品规格 Product specification.....	1
3 技术参数 Technical parameters.....	2
4 安装指南 Installation guide.....	3
4.1 外形及安装尺寸.....	3
4.1.1 产品安装 Product installation.....	3
4.2 端子及接线 Terminals and wiring.....	4
4.3 注意事项 Precautions.....	6
4.3.1 电压信号输入 Voltage input.....	6
4.3.2 电流信号输入 Current input.....	6
4.3.3 通讯接口接线 Communication interface wiring.....	6
5 使用指南 Operation guide.....	6
5.1 按键 Key.....	6
5.2 仪表开机瞬间显示为仪表版本信息.....	7
5.3 测量参数 Measurement parameters.....	7
5.3.1 电力参数 Electrical parameters.....	7
5.3.2 费率电度 Multi-rate.....	9
6 菜单符号及意义 Menu symbol and meaning.....	10
6.1 开关量输出设置 Switch output setting.....	12
6.2 编程流程 Programming process.....	14
6.3 功能设置与使用 Function setting and use.....	14
6.3.1 倍率更改设置 Magnification change settings.....	14
6.3.2 通讯功能及参数设置 Communication function and parameter setting.....	15
6.3.3 报警功能及参数设置 Alarm function and parameter setting.....	15
7 通讯指南 Communication Guide.....	15
7.1 概述 Overview.....	15
7.2 DLT645 规约 DLT645 protocol.....	16
7.3 Modbus 协议 Modbus protocol.....	18
7.3.1 数据帧 Data frame format.....	18
7.3.2 地址(Address)域 Address domain.....	18
7.3.3 功能(Function)域 Function domain.....	18
7.3.4 数据(Data)域 Data domain.....	19
7.3.5 错误校验(Check)域 Error check domain.....	19
7.3.6 错误校验的方法 Error check method.....	19
7.4 Modbus 通讯说明 MODBUS communication description.....	20
7.4.1 通信地址表(Word)Communication address table(Word).....	20
7.4.2 说明:.....	27
7.5 通讯应用 Communication application.....	27

3 技术参数 Technical parameters

技术参数 Technical parameters		指标 Index		
输入 Input	标称值 Nominal value	电压输入范围 Voltage input range	电流输入 Current input	
		DC 0-1000V 参见实物接线图 DC 0-1000V See the physical wiring diagram	分流器: 0-75mV; 霍尔传感器: 0-20mA、4-20mA、0-5V, 0-10V 等 Shunt: 0-75mV; Hall sensor: 0-20mA、4-20mA、0-5V, 0-10V and so on.	
	过载 Overload	1.2 倍可持续正常工作, 2 倍持续 1 秒 1.2 times rated (continuous); 2 times rated/1 second;		
功耗 Power consumption	电压: $\leq 0.2VA$, 电流 $\leq 0.1VA$ Voltage: $\leq 0.2VA$, current $\leq 0.1VA$			
精度等级 Accuracy class		1 级 Class 1		
功能 Function	显示 Display	8 位段码式液晶屏 (LCD) 8-bit segment LCD screen (LCD)		
	通讯接口 Communication Interface	RS485, 红外 RS485, infrared		
	通讯协议 Communication protocol	Modbus-RTU, DL/T 645-2007		
	开关量 Switch	开关量输出 Switch output	2 路继电器输出, 2A/30VDC 或 2A/250VAC 2 Relay outputs, 2A/30VDC or 2A/250VAC	
		开关量输入 Switch input	2 路干接点输入 2 dry contact inputs	
脉冲输出 Pulse output	一路秒脉冲输出, 一路电能脉冲输出 A second pulse output, a energy pulse output 见仪表菜单设置中 SYS->PLUS 中显示, 例: 显示 100, 即为 100imp/kWH See the SYS->PLUS display in the meter menu settings. For example: The meter displays 100, which is 100imp/kWH			
工作电源 Power Supply	电压范围 Voltage range	AC/DC 85-265V 或 DC24V($\pm 10\%$)或 DC48V($\pm 10\%$) AC/DC 85-265V or DC24V($\pm 10\%$) or DC48V($\pm 10\%$)		
	功耗 Power consumption	$\leq 3W$		
工频耐压 Power frequency withstand voltage		电源//电压输入//电流输入//继电器输出和开关量输入//通讯之间//脉冲输出 3kV/1min 电源、继电器输出、电压信号、电流信号之间 3kV/1min 脉冲输出、通讯、开关量输入之间 2kV/1min Power supply // Voltage input // Current input // Relay output and switch input // Communication interface // Pulse output 3kV/1min Power supply // Relay output // Voltage input // Current input 3kV/1min Pulse output // Communication interface // Switch input 2kV/1min		

绝缘电阻 Insulation resistance		$\geq 40M \Omega$
平均无障碍工作时间 Average barrier-free working hours		$\geq 50000h$
环境 Environment	温度 Temperature	正常工作温度: $-25^{\circ}C \sim +65^{\circ}C$; 极限工作温度: $-40^{\circ}C \sim +70^{\circ}C$; 贮存温度: $-40^{\circ}C \sim +80^{\circ}C$ Normal operating temperature: $-25^{\circ}C \sim +65^{\circ}C$; Limit working temperature: $-40^{\circ}C \sim +70^{\circ}C$; Storage temperature: $-40^{\circ}C \sim +80^{\circ}C$
	湿度 Humidity	$\leq 93\%RH$, 不结露, 不含腐蚀性气体 $\leq 93\%RH$, no condensation, no corrosive gas
	海拔 Altitude	$\leq 2500m$

脉冲常数: Pulse constant:

最大功率 \leq Maximum power	999.9W	10000	imp/kWh
	9.999kW	1000	imp/kWh
	99.99kW	100	imp/kWh
	999.9kW	10	imp/kWh
	9999kW	1	imp/kWh

最大功率=额定电压*电压比值*电流比值*1.2

Maximum power = rated voltage * voltage ratio * current ratio * 1.2

4 安装指南 Installation guide

4.1 外形及安装尺寸

Shape and installation dimensions

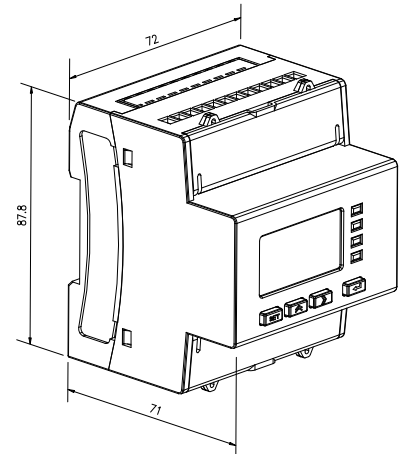
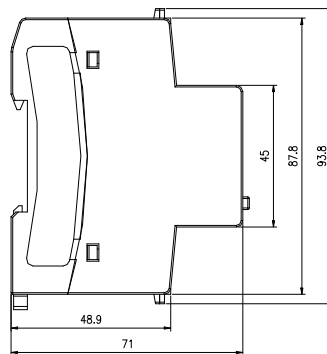

4.1.2 产品安装 Product installation

采用标准的 DIN35mm 导轨式安装

The meter is designed by standard DIN35mm rail mounted.

4.2 端子及接线 Terminals and wiring

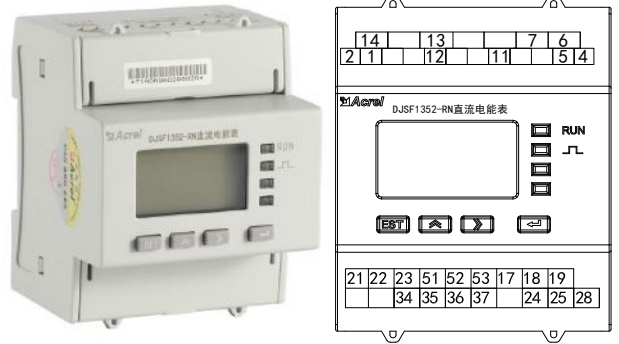
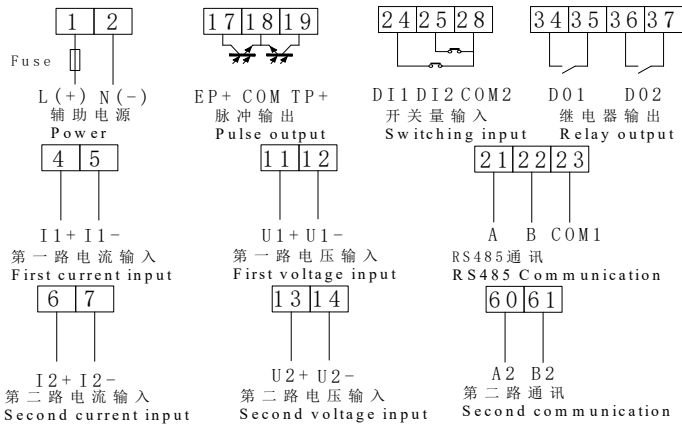

注：第二路直流输入以及DI、DO功能均为选配功能。

Note: The second DC input channel and DI and DO functions are optional.

当电流输入方式为分流器输入时：

When the current input mode is current shunt input:

三线制接法 Three-wire connection

正极电流分流器输入

负极电流分流器输入

Current shunt connected to the positive

Current shunt connected to the negative

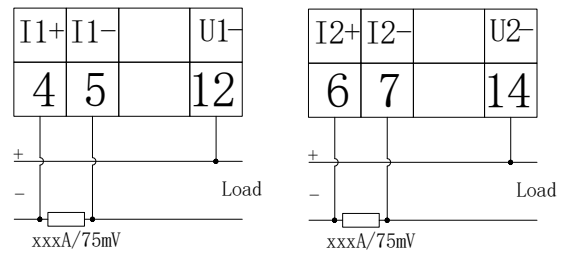
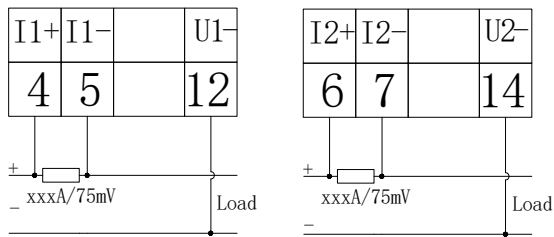

第一路直流输入 First DC input channel

第二路直流输入 Second DC input channel

四线制接法 Four-wire connection

正极电流分流器输入

负极电流分流器输入

Current shunt connected to the positive

Current shunt connected to the negative

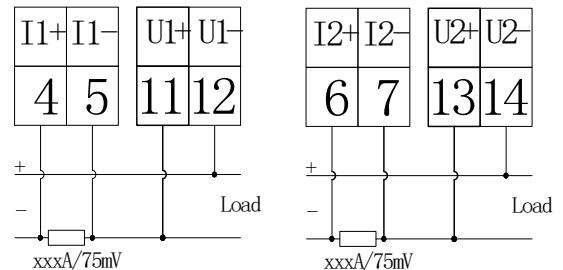
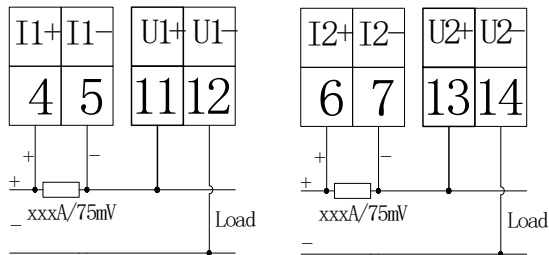

当电流输入方式为霍尔传感器输入时：

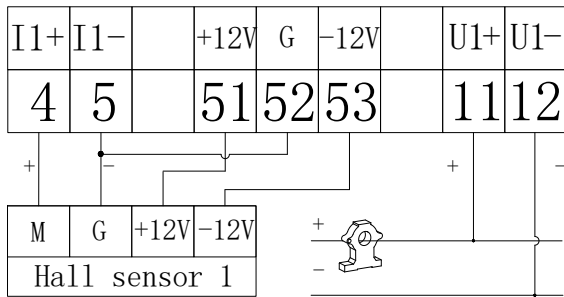

第一路直流输入 First DC input channel

- 注：1. 负极电流分流器输入时，需在仪表菜单将 **negt** 选项设置为on，详见第6节菜单编程界面。
2. 当两路电流输入均采用霍尔电流传感器输入时，第二路霍尔电流传感器的电源不能使用电表内置电源，需外配电源模块。
3. 电流采用分流器输入，四线制接法所测量的电压值会有额外千分之一左右的误差。
4. 电流信号线推荐使用0.75mm²或1mm²屏蔽双绞线，且屏蔽层需要接大地。

When the current input mode is Hall sensor input:

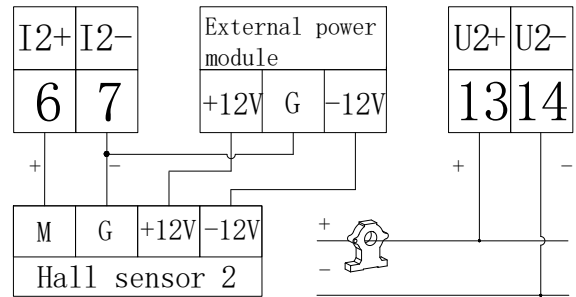

第二路直流输入 Second DC input channel

- Note: 1. When current shunt is connected to the negative, set the **negt** option to on in the meter menu, see section 6 menu programming interface for details.
2. When the two current inputs are input by the Hall current sensor, the power supply of the second Hall current sensor cannot be used with the built-in power supply of the meter, and the power module needs to be externally connected.
3. When the current is input by the shunt, the voltage value measured by the four-wire method has an error of about one thousandth.
4. It is recommended to use a 0.75mm² or 1mm² shielded twisted pair for the current signal line, and the shield layer needs to be connected to the ground.

4.3 注意事项Precautions

4.3.1 电压信号输入Voltage input

输入电压不得高于产品的额定输入电压的120%，在电压输入端须安装1A 保险丝。

The input voltage must not exceed 120% of the rated input voltage of the product. A 1A fuse must be installed on the voltage input.

4.3.2 电流信号输入Current input

电流输入应使用外部分流器或霍尔电流传感器。

An external shunt or Hall current sensor should be used for current input.

4.3.3 通讯接口接线Communication interface wiring

该仪表提供异步半双工 RS485 通讯接口，采用 MODBUS-RTU 协议，各种数据信息均可在通讯线路上传送。理论上在一条线路上可以同时连接多达 128 个仪表，每个仪表均可设定其通讯地址（Addr）、通讯速率（baud）也可通过设置选择。

The meter provides asynchronous half-duplex RS485 communication interface using MODBUS-RTU protocol, a variety of data information can be transmitted on the communication line. Theoretically, up to 128 meters can be connected simultaneously on a single line. Each meter can be set with its address (Addr), baud rate, or setting selection.

通讯连接建议使用三芯屏蔽线，每芯截面不小于 0.5mm^2 ，分别接 A、B，屏蔽层接大地，布线时应使通讯线远离强电电缆或其他强电场环境。



The communication connection is recommended to use three-core shielded cable, Cross-sectional area of each core is not less than 0.5mm^2 , is connected to A、B respectively, shielding layer is connected to the earth. The wiring should be kept away from strong cables or other strong electric field environment.



建议起始端和最末端仪表的 A、B 之间均加匹配电阻，阻值范围为 $20\Omega \sim 10\text{k}\Omega$ 。

It is recommended to add matching resistors between A and B of the meters at the beginning and end. The resistance range is 20Ω to $10\text{k}\Omega$.

5 使用指南 Operation guide

5.1 按键 Key

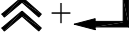
Set	<p>测量模式下，按该键进入编程模式，仪表提示输入密码 PASS，输入正确密码后，可对仪表进行编程设置；编程模式下，用于返回上一级菜单</p> <p>In the measurement mode, press this key to enter the programming mode. The meter prompts you to enter the password PASS. After you enter the correct password, you can program the instrument; in the programming mode, it returns to the previous menu.</p>
	<p>测量模式下，用于切换显示项目，查看各项电量，具体见显示菜单；编程模式下，用于切换同级菜单或个位数的减小。</p> <p>In the measurement mode, it is used to switch the display item and view the electrical parameters, see the display menu for details;</p> <p>In the programming mode, it is used to switch the menu of the same level or reduce the number of ones place.</p>
	<p>测量模式下，可查看相关参数，查看各项电量，具体见显示菜单；编程模式下，用于切换同级菜单或个位数的增加。</p> <p>In the measurement mode, it is used to switch the display item and view the electrical parameters, see the display menu for details;</p> <p>In the programming mode, it is used to switch the menu of the same level or add the number of ones place.</p>

	编程模式下，用于菜单项目的选择确认和参数的修改确认。 In the programming mode, it is used to confirm the selection of menu items and modify the parameters.
	编程模式下，该组合键用于百位数的减小 In the programming mode, this key combination is used to reduce the number of hundreds place.
	编程模式下，该组合键用于百位数的增加 In the programming mode, this key combination is used to add the number of hundreds place.

5.2 仪表开机瞬间显示为仪表版本信息

Meter displays the version information for the meter instantly when starts up.

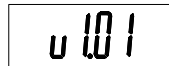

5.3 测量参数 Measurement parameters

5.3.1 电力参数 Electrical parameters

上、右键循环切换显示 如下图所示：按上、右键可如下图切换显示其它界面：电流 ↔ 电压 → 功率 ↔ 当前正向有功电能 ↔ 历史反向有功电能 ↔ 当前日期时间 ↔ 温度。

Press the up and right key to switch display circularly, as is shown in the following figure: Press the up or right key to switch display the other interface as follows: Current ← → Voltage ← → Power ← → Current positive active energy ← → History reverse active energy ← → Current date time ← → Temperature.

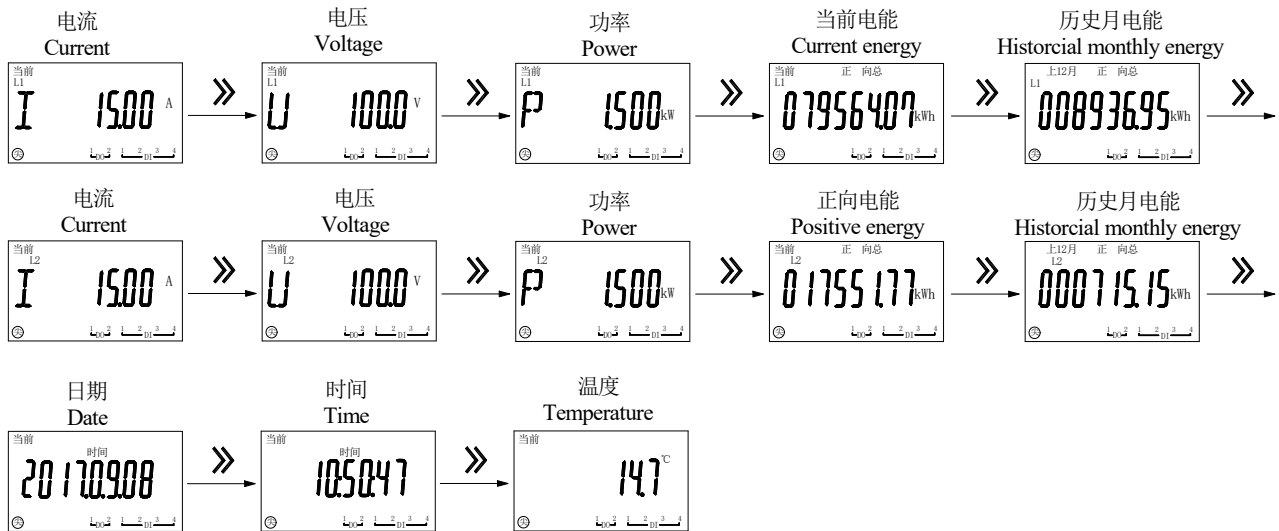

注：1、L1、L2 分别表示第一路、第二路直流输入，
当未选配第二路直流输入时，L2 参数界面不显示；
2、当功率为负值时，屏幕闪烁；
3、费率电度只有在仪表带此功能时显示。

Note: 1. L1 and L2 represent the first and second DC input respectively. When the second DC input is not selected, the L2 parameter interface is not displayed.
2. When the power is negative, the screen flickers;
3. Multi-rate energy is only displayed when the instrument with this function.

仪表上电后显示电流显示界面后，按回车键切换显示：电流最大值→电流最大值发生时间（年、月、日）→电流最大值发生时间（时、分、秒）→电流最小值→电流最小值发生时间（年、月、日）→电流最小值发生时间（时、分、秒）→正向最大需量→正向最大需量发生时间（月、日、时、分）→反向最大需量→反向最大需量发生时间（月、日、时、分）。

The current display interface is displayed after the meter is powered on, press the enter key to switch the display: Maximum current → Occurrence time of maximum current (year, month, day) → Occurrence time of maximum current (hour, minute, second) → Minimum Current → Occurrence time of minimum current (year, month, day) → Occurrence time of minimum current (hour, minute, second) → Maximum positive demand → Occurrence time of maximum positive demand (month, day, hour, minute) → Reverse maximum demand → Occurrence time of reverse maximum demand (month, day, hour, minute).

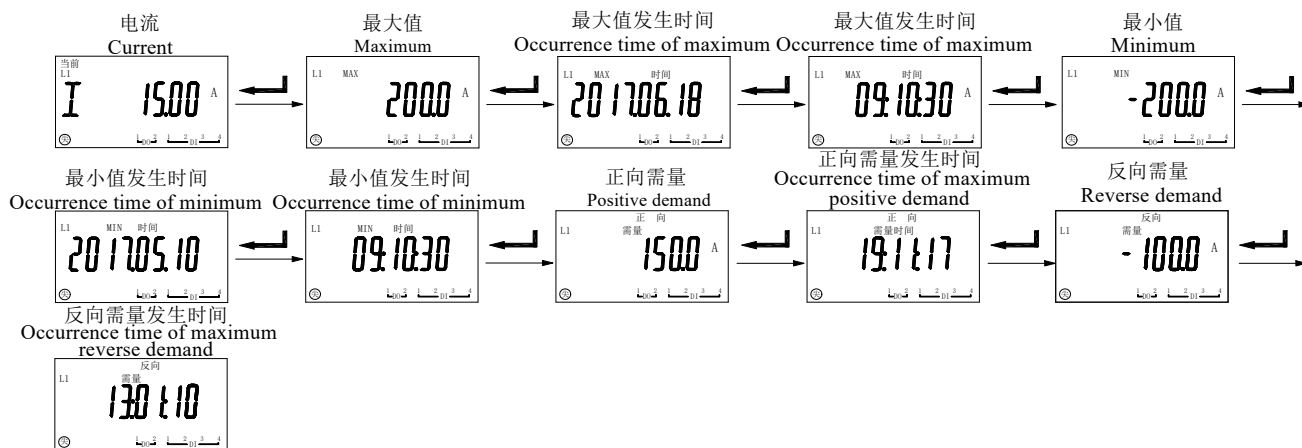

仪表上电后在电流显示界面，按右键切换到电压显示界面后，按回车键切换显示：电压最大值→电压最大值发生日期（年、月、日）→电压最大值发生时间（时、分、秒）→电压最小值→电压最小值发生日期（年、月、日）→电压最小值发生时间（时、分、秒）。

The current display interface is displayed after the meter is powered on, press the right key to switch to the voltage display interface, press the enter key to switch the display: Maximum voltage → Occurrence time of maximum voltage (year, month, day) → Occurrence time of maximum voltage (hour, minute, second) → Minimum voltage → Occurrence time of minimum voltage (year, month, day) → Occurrence time of minimum voltage (hour, minute, second).

仪表上电后显示电流显示界面，按左右键切换到功率显示界面后，按回车键切换显示：功率最大值→功率最大值发生日期（年、月、日）→功率最大值发生时间（时、分、秒）→功率最小值→功率最小值发生日期（年、月、日）→功率最小值发生时间（时、分、秒）→正向最大需量→正向最大需量发生时间（月、日、时、分）→反向最大需量→反向最大需量发生时间（月、日、时、分）。

The current display interface is displayed after the meter is powered on, press the left or right key to switch the power display interface. Press the enter key to switch the display: Maximum power → Occurrence time of maximum power (year, month, date) → Occurrence time of maximum power (hour, minutes, seconds) → Minimum power → Occurrence time of minimum power occurrence date (year, month, day) → power minimum occurrence time (hour, minute, second) → positive maximum demand → positive maximum demand occurrence time (month, day, hour, minute) → Reverse Maximum Demand → Reverse Maximum Demand Occurrence Time (month, day, hour, minute).

注：电压、功率需量显示界面均与电流需量显示界面相同。

Note: The voltage and power demand display interfaces are the same as the current demand display interface.

5.3.2 费率电度 Multi-rate

仪表开机后显示电流显示界面时，按右键切换到总正向有功电能显示界面后，按回车键切换显示：总正向有功电能→总正向有功电能（尖）→总正向有功电能（峰）→总正向有功电能（平）→总正向有功电能（谷）→总反向有功电能（尖）→总反向有功电能（峰）→总反向有功电能（平）→总反向有功电能（谷）。

When the meter displays the current display interface after powering on, press the right key to switch to the total positive active energy display interface, press the enter key to switch the display: Total positive active energy → Total positive active energy (sharp) → Total positive active energy (Peak) → Total positive active energy (shoulder) → Total positive active energy (off—peak) → Total reverse active energy (sharp) → Total reverse active energy (peak) → Total reverse active energy (shoulder) → Total reverse active energy (off—peak).

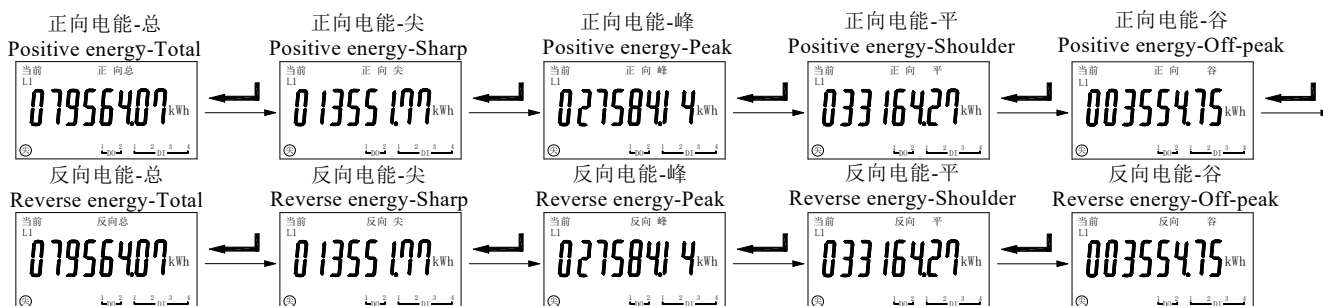

仪表开机后显示电流显示界面时，按右键切换到历史月电能查询显示界面后，按回车键切换显示：所查月正向有功电能（尖）→所查月正向有功电能（峰）→所查月正向有功电能（平）→所查月正向有功电能（谷）→所查月反向有功电能（总）→所查月反向有功电能（尖）→所查月反向有功电能（峰）→所查月反向有功电能（平）→所查月反向有功电能（谷）→查询电能的日期设置（年、月）。

When the meter displays the current display interface after powering on, press the right key to switch to the query display interface of historical energy for month, press the enter key to switch the display interface: the searched positive active energy for month (sharp) → the searched positive active energy for month (peak) → the searched positive active energy for month (shoulder) → the searched positive active energy for month (off—peak) → the searched reverse active energy for month (total) → the searched reverse active energy for month (sharp) → the searched reverse active energy for month (peak) → the searched reverse active energy for month (shoulder) → the searched reverse active energy for month (off—peak) → Date setting of the query of the energy (year, month).

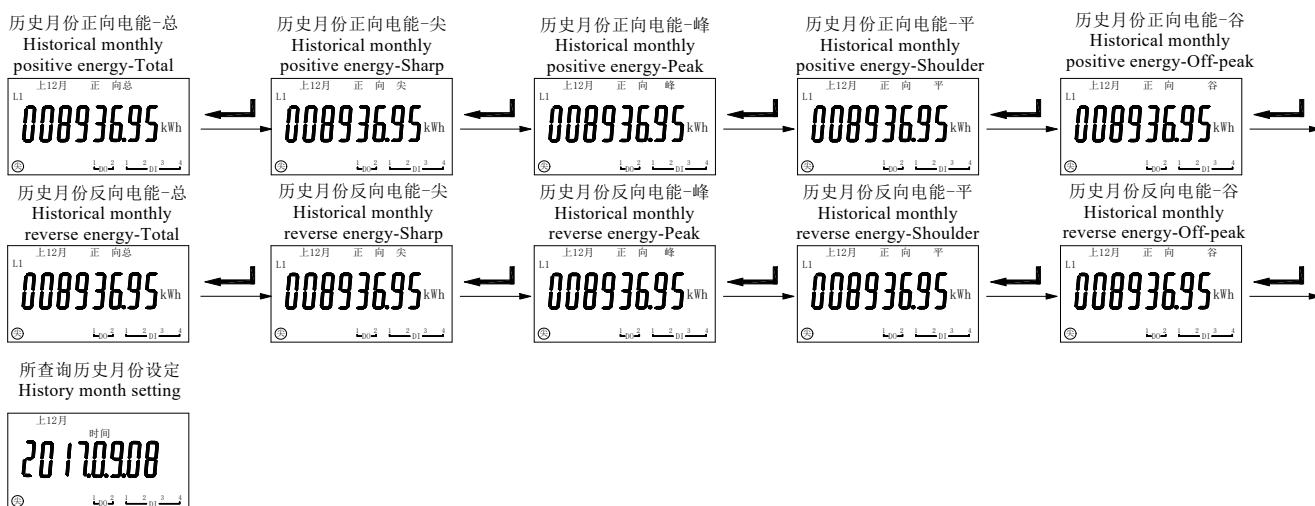

注：在“历史月份设定”界面按右键可设置所要查询的历史月份

Note: Right click on the “History month setting” interface to set the historical month to be queried.

6 菜单符号及意义 Menu symbol and meaning

仪表开机后显示电流显示界面，按 SET 键切换到 PASS（按右键更改密码为 0001）进入菜单编程界面，按左右键依次显示如下：

After the meter is turned on, the current display interface is displayed. Press the SET key to switch to PASS (press the right key to change the password to 0001) to enter the menu programming interface. Press the left and right keys to display the following:

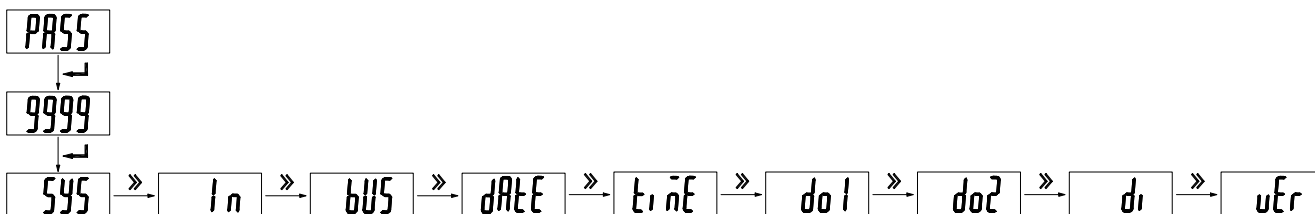

第一级菜单 First level menu	第二级菜单 Second level menu	第三级菜单 Third level menu	说明 Instructions
545	dISP	0001	开机显示画面选择，为零自动翻页 Selection of boot display, zero means turning automatically
	bLd	0-255（可设）	设置为 0 时，背光常亮；设置为 1-255 时，背光在 1-255 秒后熄灭，单位：1 秒 When set to 0, the backlight is always on; when set to 1-255, the backlight is off after 1-255 seconds. Unit: 1 second
	Code	0000-9999	密码设置（初始密码 0001） Password setting (initial password is 0001)
	ALSt	0000H	当前报警状态，十六进制显示，低位为 do1,高位为 do2,从 bit0-bit7,依次为过电压、欠电压、过流、欠载、过功率、欠功率、DI1、DI2 The current alarm status, hexadecimal display, low bits for do1, high bits for do2, from bit0-bit7, followed by overvoltage, undervoltage, overcurrent, underload, overpower, underpower, DI1, DI2
	CLrEP	000-9999	清除电能 Clear energy

	CLrdn	(输入 9996 后确认清除) 000-9999 (Enter 9996 to confirm clear)	清除需量 Clear demand
	CLrnin		清除最值 Clear extremum
	CLrdio		清除开关量动作事件记录 Clear event records of switch action
	CLrfr2		清除冻结电能 Clear frozen energy
	CLrSoE		清除时间和变成设置事件记录 Clear time and programming event logs
	PLUS	1, 10, 100, 1000, 10000	脉冲常数 (imp/kWh) Pulse constant (imp/kWh)
	FLASH	0=no, 1=U, 2=I, 3=IU, 4=P, 5=PU, 6=PI, 7=PIU	控制输入为负时闪烁显示, U 表示电压, I 表示电 流,P 表示功率 Flicker when the input is negative, U means voltage, I means current, P means power
	EPdot	2,3	电能小数点位置设置:显示小数点后 2 位,3 位 Energy decimal point position setting: 2 digits or 3 digits after decimal point are displayed
	LESS U	0-5.0	电压零点屏蔽值设定, 最大±5% Masking value setting of voltage zero point, maximum to ±5%
	LESS I	0-5.0	电流零点屏蔽值设定, 最大±5% Masking value setting of current zero point, maximum to ±5%
In	InPU	0001-9999	第一路电压变比 First Voltage transformation ratio
	InPI	0001-9999	第一路电流变比 (一次电流值) First current transformation ratio (Primary rated current)
	In2PI	0001-9999	第二路电流变比 (一次电流值) Second current transformation ratio (Primary rated current)
	NEGt	on,off	on:负极电流分流器输入 on:Current shunt connected to the negative off:正极电流分流器输入 off:Current shunt connected to the positive
BUS	Addr	1-247	485 通讯地址 485 address
	BAUD	4800,9600,19200	485, 645 通讯波特率 485,645 Communication baud rate
	mode	None,2bit,odd,even	485, 645 通信模式 (无校验,2 位停止位,奇校验,偶校验) 485,645 Communication Mode (No parity, 2 stop bits, odd parity, even parity)
	645Addr	000000H(12 位地址高 位) 000000H (high 12-bit of address) 000001L(12 位地址低 位) 000000L (low 12-bit of address)	645 表号, H 表示高 6 位表号 BCD, L 表示低 6 位 表号 (面板上只能读取, 需用上位机软件设置) 645 meter number, H represents the high 6-digit meter number BCD, L represents the low 6-digit meter number (can only be read on the panel, need to be set by the upper computer software)

	baud	1200,2400,4800,9600	红外通讯波特率 Infrared communication baud rate															
	mode	None,2bit,odd,even	红外通信模式 (无校验,2位停止位,奇校验,偶校验) Infrared communication mode (No parity, 2 stop bits, odd parity, even parity)															
	dlfe	add0, add4	回送 645 报文增加前导符 FE: 0 个,4 个 Add the FE headers of sent back 645 message to: 0, 4															
date	171122 150718		年月日, 数字闪烁即表示被选中可设置 Year, month, day, when the number is flashing, it means that it is selected and can be set															
time			时分秒, 数字闪烁即表示被选中可设置 Hour, minute, second, when the number is flashing, it means that it is selected and can be set															
do1			开关量输出设置 (详见 6.1) Switch output setting (See 6.1 for details)															
do2																		
di	type	00, 01, 10, 11	<table border="1" style="float: right;"> <tr> <td></td> <td>DI</td> <td>DO</td> </tr> <tr> <td>0</td> <td></td> <td>ON</td> </tr> <tr> <td></td> <td></td> <td>OFF</td> </tr> <tr> <td>1</td> <td></td> <td>ON</td> </tr> <tr> <td></td> <td></td> <td>OFF</td> </tr> </table> <p>十位表示 DI1, 个位表示 DI2。 0 为常闭, 1 为常开 (带 DI 联动报警时有效, 详见 6.1) Tens place indicates DI1 and ones place indicates DI2. 0 is normally closed and 1 is normally open (effective with DI linkage alarm. See 6.1 for details)</p>		DI	DO	0		ON			OFF	1		ON			OFF
	DI	DO																
0		ON																
		OFF																
1		ON																
		OFF																
ver	v01		软件版本 Software version															

注: 事件记录菜单中无法查询, 只能通过通讯读取。

Note: The query cannot be queried in the event log by menu. It can only be read via communication.

6.1 开关量输出设置 Switch output setting

仪表开关量输出采用继电器输出, 有两种控制方式: 1、报警方式 (“SEL” 选择不为零); 2、总线控制方式 (“SEL” 选择为 “0.do”, 此时 “dLy” 设置为 0 为电平输出方式, 设置非零为脉冲方式动作后延时设置的时间自动断开)

“SEL” 中设置 DO 输出类型, “0.do” 表示为通信控制(此时如果 DLY 设置为 0 输出为电平方式, 否则为脉冲方式, 如果 DLY 设置为 2, 吸合后 0.02 秒自动断开), 其他为报警控制 (见下表)

“dLy” 为报警延时 (报警用时推荐不设置为 0 防止干扰误动。)

“bAnd” 为不动作带设置

The switch output of the meter adopts relay output. There are two control modes: 1. Alarm mode ("SEL" selection is not zero); 2. Bus control mode ("SEL" is selected as "0.do". When "dLy" is set to 0, it is the level output mode. Setting non-zero as the pulse mode will automatically disconnect the delay setting time.

“SEL” sets the DO output type. “0.do” means communication control. (If DLY is set to 0, the output is in level mode, otherwise it is in pulse mode. If DLY is set to 2, automatic shutdown will take 0.02 seconds after pull in. Open), same as alarm control (see the following table)

“dLy” is the alarm delay time (it is not recommended to set to 0 during the alarm to prevent interference error.)

"BAnd" is set for the non action band

do1	第一路继电器输出 First relay output	
SEL	0 do	由通信控制的 DO 输出模式，此时“dLy”为 0 则为电平控制。设置其他值为自动返回模式。DO 动作后延时“dLy”（单位为 0.01 秒）后自动断开 The DO output mode controlled by the communication, when "dLy" is 0, it is the level control. Set the other value to auto return mode. DO disconnect automatically after delay "dLy" (in 0.01 seconds) after action.
	1 RL	第一路直流电参量报警 Alarm of the first DC parameter
	2 d1 RL	第一路直流电参量、联动开关量报警，逻辑为或 Alarm of the first DC parameter and linkage switch, logic is or
	3 d1 1	联动 DI1 报警 Linkage alarm DI1
	4 d1 2	联动 DI2 报警 Linkage alarm DI2
	5 d1.12	联动 DI1、DI2 报警，逻辑状态为或 Linkage alarm DI1、DI2, logic is or
	6 RL	第二路直流电参量报警 Alarm of the second DC parameter
	7 d1 RL	第二路直流电参量带开关量报警 Alarm of the second DC parameter with switch
H-rES	on	手动复归开启（在主界面按回车键使继电器触点断开，主要用于消音） Manual reset is turned on (Press the enter key on the main interface to make the relay contact open, mainly used for silence)
	off	手动复归关闭 Manual reset is turned off
dLY	输出延时时间：如果为 DO 输出方式，设置为 0 时，为电平控制方式，非 0 时为脉冲控制方式，延时设置的时间后断开，延时设置范围 1—255 时，单位：0.01 秒；如果为报警输出方式，延时设置范围 1—9999 时，单位：1 秒； Output delay time: If it is DO output mode, when it is set to 0, it is the level control mode; when it is not 0, it is the pulse control mode, and is disconnected after the setted delay time, the delay setting range is 1-255, unit: 0.01 seconds; if it is alarm output mode, delay setting range is 1-9999, unit: 1 second;	
bAnd	不动作带区间 Non action band	
H-U	电压高报警，按百分比进行设置 High voltage alarm, set by percentage	
L-U	电压低报警，按百分比进行设置 Low voltage alarm, set by percentage	
H-I	电流高报警，按百分比进行设置 High current alarm, set by percentage	
L-I	电流低报警，按百分比进行设置 Low current alarm, set by percentage	
H-P	功率高报警，按百分比进行设置 High power alarm, set by percentage	
L-P	功率低报警，按百分比进行设置 Low power alarm, set by percentage	
0=AL	0AL	零值报警使能 Zero alarm enable
	0oFF	零值报警关闭（低报警） Zero alarm is disabled(Low alarm)

注：do2 设置同 do1。

Note: do2 setting is the same as do1.

仪表菜单结构

Meter menu structure

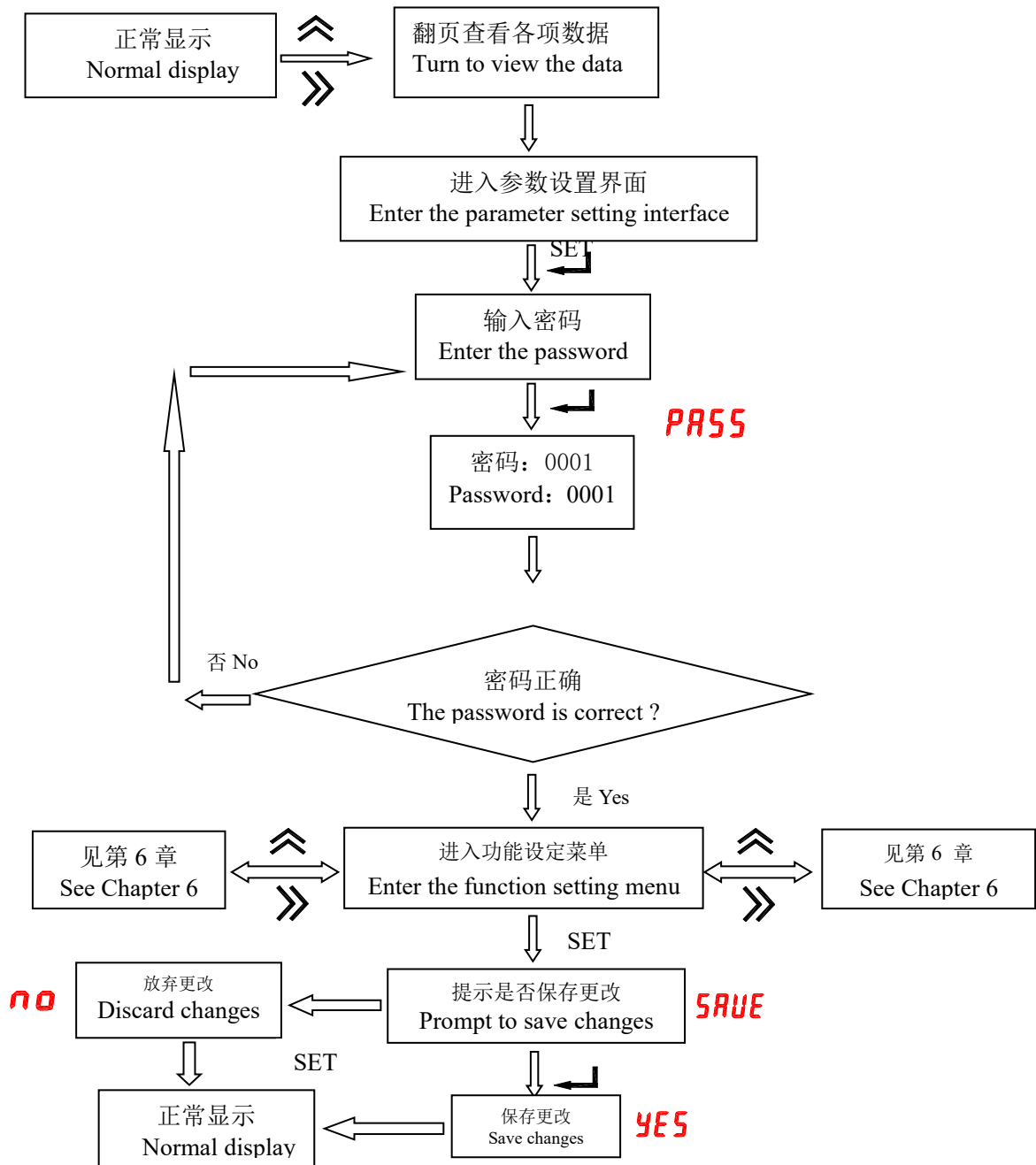

6.3 功能设置与使用 Function setting and use

6.3.1 倍率更改设置 Magnification change settings

电压以当前额定电压为基准，电流变比是以 1A 为基准，出厂时根据用户的量程要求，确定合适的仪表量程，在外部输入此量程的信号，若电流变比都为“100”，则仪表显示 100.0A，在设定了对应的变比后，仪表将显示对应的数据。用户不得自行改变信号的输入大小。如用户定了 100A/75mV 仪表，到了工作现场发现电压变送器为 500A/75mV，电流

变比由 100 改为 500，但需确定直流变送器的输出信号不得发生改变，此例中为 75mV。

The voltage is based on the current rated voltage, and the current transformation ratio is based on 1A. According to the user's measurement range, the appropriate meter range is determined at the factory, and the signal of this range is input externally. If the current change ratio is “100”, then the meter displays

100.0A. After the corresponding ratio is set, the meter will display the corresponding data. Users are not allowed to change the input size of the signal by themselves. If the user has set a 100A/75mV meter and found the voltage transmitter at the work site to be

500A/75mV, the current transformation ratio is changed from 100 to 500, but it must be confirmed that the output signal of the DC transmitter cannot be changed, in this case it is 75mV.

6.3.2 通讯功能及参数设置 Communication function and parameter setting

Modbus-RTU 协议：默认为“9600, 8, n, 1”。

Modbus-RTU protocol: The default is "9600,8,n,1".

6.3.3 报警功能及参数设置 Alarm function and parameter setting

正常测量时，有报警产生，并且会在继电器输出上产生一个输出（需加配，继电器常开结点闭合），对应 DO 显示位相应显示。

In the normal measurement, an alarm is generated and an output is generated on the relay output (need to be added, normally open relay contact is closed), the corresponding display of the DO displays.

报警状态可通讯读取，参量地址见通讯参量地址表

The alarm status can be read by communication. See the communication parameter address table for the parameter address.

报警功能默认为关闭状态，除非客户要求。

The alarm function is turned off by default unless requested by the customer.

当输入信号为零时，仪表可通过设置关闭或打开低报警功能。

When the input signal is zero, the meter can be set to turn off or on the low alarm function.

7 通讯指南 Communication Guide

7.1 概述 Overview

DJSF1352-RN 仪表采用 Modbus-RTU 协议：“9600, 8, n, 1”，其中 38400 为默认波特率，可通过编程修改为 1200、2400、4800、9600 等；8 表示有 8 个数据位；n 表示无奇偶校验位；1 表示有 1 个停止位。

The DJSF1352-RN meter uses the Modbus-RTU protocol: “9600, 8, n, 1”, where 38400 is the default baud rate, which can be programmed to change to 1200, 2400, 4800, 9600, etc.; 8 means there are 8 data bits ;n indicates no parity; 1 indicates 1 stop bit.

错误检测：CRC16（循环冗余校验）

Error detection: CRC16 (Cyclic Redundancy Check)

DJSF1352-RN 仪表采用 DLT645 协议,支持 07、97 版本，仪表表号默认为条形码后 12 位，详见菜单设置。规约支持电压、电流、功率、正反向及组合电能的读取，复费率电能读取，同时 07 版本规约还支持编程记录，时间设置的 10 次事件的读取,12 个月的复费率及需量的读取，3 次数据瞬时冻结和 12 次定时冻结的数据查询。

DJSF1352-RN meter adopts DLT645 protocol, supports 07, 97 version. The meter number defaults to 12 digits after barcode. See menu settings for details. The protocol supports reading of voltage, current, power, forward and reverse direction and combined energy and reading of multi-rate energy. At the same time, the version 07 protocol also supports programming records, reading of 10 events of time setting, and 12 months of multi-rate energy and demand, 3 times data instantaneous freezing and 12 times frozen data query.

注意：当仪表选配双路直流，第二路直流测量数据读取时，通讯地址自动在原来地址上加 1。（modbus 设备地址加 1,645 表号自增 1，合计占 2 个号，相当于 2 个表）。

Note: When the meter is equipped with double DC input channels and the measurement data of second DC channel is read, the communication address is automatically added 1 to the original

address.(The modbus device address plus 1,645 number is incremented by 1, and it occupies 2

7.2 DLT645 规约 DLT645 protocol

DJSF1352-RN 仪表采用 DLT645 协议,支持 07、97 版本, 仪表表号默认为条形码后 12 位, 详见菜单设置。规约支持电压、电流、功率、正反向及组合电能的读取, 复费率电能读取。

97 规约只支持基本电参量和电能的读取, 97 规约电压最高 9999V, 如果额定电流值超过规约的允许值, 随额定电流增大而以 10 倍的规律变小, 额定功率值如果超过规约的允许值, 固定变小 1000 倍。

07 规约还支持编程记录, 时间设置的 10 次事件的读取,12 个月的复费率及需量的读取, 3 次数据瞬时冻结和 12 次定时冻结的数据查询。

07 规约修改部分功能 Part of the modified function of the 07 protocol

读取电压为正数, 及时输入为负绝对值显示。读取电流和功率为有符号数, 最大 0-799999 (电流最大 ±799.999A 或 KA, 功率最大 79.9999kw 或 (MW))。单位是否切换见下表中说明。

numbers in total, equivalent to 2 meters).

DJSF1352-RN meter adopts DLT645 protocol, supports 07, 97 version. The meter number defaults to 12 digits after barcode. See menu settings for details.The protocol supports reading of voltage, current, power, forward and reverse direction and combined energy, and multi-rate energy reading.

The 97 protocol only supports the reading of basic electrical parameters and electrical energy. The voltage of 97 protocol is up to 9999V. If the rated current exceeds the allowable value of the protocol, it will become smaller with a factor of 10 with the increase of the rated current, if the rated power exceeds the allowable value of the protocol ,it's fixed 1000 times smaller.

The 07 protocol also supports programming records, reading of 10 events of time setting, reading of 12-month multi-rates and demand, 3 times instantaneous frozen data, and 12 times frozen data queries.

The reading voltage is positive and the input is negative absolute value display.Read current and power are signed number, maximum 0-799999 (current max. ±799.999A or KA, power max. 79.9999kw or (MW)). Whether or not the unit is switched is described in the following table.

标识符 Identifier	长度 Length	备注 Note
02010100	2	读取电压, 如果读取到 999.9V 此时为越界状态, 实际电压超过 1000V, 无负数 Read voltage, if 999.9V is read at this time, it is an out-of-bounds state, actual voltage exceeds 1000V, there is no negative number.
04000501	2	bit0 表示功率反向, bit2 表示电流反向, bit3 表示功率反向, bit8 表示 DI1, bit9 表示 DI2, bit12 表示 DO1, bit13 表示 DO2。 Bit0 means power reverse, bit2 means current direction, Bit3 means power reverse, bit8 means DI1, bit9 means DI2, bit12 means DO1, bit13 means DO2.
04808080	2	读取 PT 比值 (一般为变送二次接入电压时使用) Read PT ratio (usually used when transferring secondary access voltage)
04808081	2	读取电流一次值 (例 200A/75mV 读取为 200) Read primary rated current (For example ,200A/75mV is read as 200)
04808082	2	读取越界状态, bit0 表示过压超过 1000V, bit1 表示电流规约不够显示, 02020100 标识符实际读取的数据被除以 1000; bit2 表示功率规约不够显示, 02030000 标识符实际读取的数据被除以 1000; Read out-of-bounds state, bit0 indicates over voltage exceeds 1000V, bit1

		indicates that the current protocol is not enough to display, the actual data read by the identifier 02020100 is divided by 1000; bit2 indicates that the power protocol is not enough to display, and the 02030000 identifier actually reads data divided by 1000;
04808083	2	实际电流倍数, 额定电流 1.2 倍 999A 以内为 1, 超过 999A 为 1000(02020100 读取值被除以 1000) Actual current ratio, 1.2 times rated current within 999A is 1, over 999A is 1000 (02020100 reading value is divided by 1000)
04808084	2	实际功率倍数, 额定功率 1.2 倍 99KW 以内为 1, 超过 99KW 为 1000(02030000 读取值被除以 1000) Actual power ratio, 1.2 times rated power within 99KW is 1, over 99KW is 1000 (02030000 reading value is divided by 1000)
04808085	2	设置的第 1 路 DO 对应的报警状态, 使用第一组报警阈值进行报警, 报警信号源于 DO1 报警源选择, DI 做报警源时双路输入时均可读到, 报警状态见注 2 Set the corresponding alarm status of DO1, The first set of alarm thresholds is used to alarm. The alarm signal originates from the DO1 alarm selection. When DI is used as the alarm source, it can be read by the double input channels. The alarm status is shown in Note 2.
04808086	2	设置的第 2 路 DO 对应的报警状态, 使用第二组报警阈值进行报警, 报警信号源于 DO2 报警源选择, DI 做报警源时双路输入时均可读到, 报警状态见注 2 Set the corresponding alarm status of DO2. The second set of alarm thresholds is used to alarm using. The alarm signal is sourced from the DO2 alarm source selection. When DI is used as the alarm source, it can be read by the double input channels. The alarm status is shown in Note 2.
04808087	2	读取电压值, 同 02010100, 读取的数值被除以 10 倍 Read voltage value, same as 02010100, read value is divided by 10 times
04808088	2	温度 Temperature

注:1.AAAAAAAAAAAAAA 使用 15H 功能写设置 645 规约地址, 要求按键输入密码进入菜单后;

Note:1.AAAAAAAAAAAAAA writes the 645 protocol address using the 15H function, requiring the user to enter the password to enter the menu;

2.

7	6	5	4	3	2	1	0
DI2	DI1	L-P	H-P	L-I	H-I	L-U	H-U
第 2 路开关量输入 No. 2 switch input	第 1 路开关量输入 No. 1 switch input	欠功率 Under power	过功率 Overpower	欠流 Undercurrent	过流 Over current	欠压 Under voltage	过压 Over voltage
DO1 告警状态 DO1 alarm status							

3. 读取电压最大为 999V, 如果额定超过, 使用特殊指令 04808087 读取;

3. The maximum reading voltage is 999V. If the rating exceeds, use the special command 04808087 to read;

4.按照标准规约，如果额定电流、功率不够显示时，读取到的通信值将被缩小 1000 倍。

4. According to the standard specification, if the rated current or power is not enough to display, the read communication value will be reduced by 1000 times.

7.3 Modbus 协议 Modbus protocol

当数据帧到达终端设备时，它通过一个简单的“端口”进入被寻址到的设备，该设备去掉数据帧的“信封”（数据头），读取数据，如果没有错误，就执行数据所请求的任务，然后，它将自己生成的数据加入到取得的“信封”中，把数据帧返回给发送者。返回的响应数据中包含了以下内容：终端从机地址(Address)、被执行了的命令(Function)、执行命令生成的被请求数据(Data)和一个 CRC 校验码(Check)。发生任何错误都不会有成功的响应，或者返回一个错误指示帧。

When the data frame arrives at the terminal device, it enters the addressed device through a simple "port", the device removes the "envelope"(data header) of the data frame, reads the data, and if there is no error, executes the task requested by the data, then it will add its own data to the obtained "envelope" and return the data frame to the sender. The returned response data includes the following contents: the terminal slave address(Address), the executed command(Function), the requested data generated by executing command(Data), and a check code(Check). There will be no successful response to any error, or an error indication frame is returned.

7.3.1 数据帧 Data frame format

Address	Function	Data	Check
8-Bits	8-Bits	N×8-Bits	16-Bits

7.3.2 地址(Address)域 Address domain

地址域在帧首，由一个字节（8-Bits，8 位二进制码）组成，十进制为 0~255，在我们的系统中只使用 1~247，其它地址保留。这些位标明了用户指定的终端设备的地址，该设备将接收来自与之相连的主机数据。同一总线上每个终端设备的地址必须是唯一的，只有被寻址到的终端才会响应包含了该地址的查询。当终端发送回一个响应，响应中的从机地址数据便告诉了主机哪台终端正与之进行通信。

The address domain is at the beginning of the frame and consists of one byte (8-bits, 8-bit binary code). The decimal value is 0 to 255. Only 1 to 247 are used in our system, and other addresses are reserved. These bits indicate the address of the user-specified terminal device that will receive data from the host to which it is connected. The address of each terminal device must be unique. Only the terminal to which it is addressed will respond to a query containing the address. When the terminal sends back a response, the data of the slave address in the response tells the host which terminal is communicating with it.

7.3.3 功能(Function)域 Function domain

功能域代码告诉了被寻址到的终端执行何种功能。下表列出了该系列仪表用到的功能码，以及它们的意义和功能。

The function field code tells the functions of the addressed terminal. The following table lists the function codes used by this series of instruments, as well as their meanings and functions.

代码（十六进制） Code (hex)	意义 Meaning	行为 Function
03H	读取保持寄存器 Read holding register	在一个或多个保持寄存器中取得当前的二进制值 Get the current binary value in one or more holding registers

10H	预置多寄存器 Preset multiple registers	把具体的二进制值装入一串连续的保持寄存器 Load specific binary values into a series of consecutive holding registers
-----	-------------------------------------	--

7.3.4 数据 (Data) 域 Data domain

数据域包含了终端执行特定功能所需的数据或终端响应查询时采集到的数据。这些数据可能是数值、参量地址或者设置值。

例如：功能域告诉终端读取一个寄存器，数据域则需要指明从哪个寄存器开始及读取多少个数据，内嵌的地址和数据依照类型和从机之间的不同而内容有所不同。

The data domain contains the data required for the terminal to perform a specific function or the data collected when the terminal responds to a query. These data may be numeric values, parameter addresses, or setting values.

For example, the function domain tells the terminal to read a register, and the data domain needs to specify which register to start and how many data to read. The embedded address and data differ according to the type and the slave.

7.3.5 错误校验 (Check) 域 Error check domain

该域采用 CRC16 循环冗余校验, 允许主机和终端检查传输过程中的错误。有时由于电噪声和其它干扰, 一组数据从一个设备传输到另一个设备时, 在线路上可能会发生一些改变, 错误校验能够保证主机或从机不去响应那些发生改变的数据, 这就提高了系统的安全性、可靠性和效率。

This domain uses a CRC16 cyclic redundancy check to allow hosts and terminals to check for errors during transmission. Sometimes due to electrical noise and other interference, when a group of data is transferred from one device to another, some changes may occur on the line. Error checking can ensure that the master or slave does not respond to those changed data. This improves the security, reliability, and efficiency of system.

7.3.6 错误校验的方法 Error check method

错误校验 (CRC) 域占用两个字节, 包含了一个 16 位的二进制值。CRC 值由传输设备计算出来, 然后附加到数据帧上, 接收设备在接受数据时重新计算 CRC 值, 然后与接收到的 CRC 域中的值进行比较, 如果这两个值不相等, 就发生了错误。

The error check (CRC) domain occupies two bytes and contains a 16-bit binary value. The CRC value is calculated by the transmitting device and then appended to the data frame. The receiving device recalculates the CRC value when receiving the data, and then compares it with the value in the received CRC domain. If the two values are not equal, it occurs error.

CRC 运算时, 首先将一个 16 位的寄存器预置为全 1, 然后连续把数据帧中的每个字节中的 8 位与该寄存器的当前值进行运算, 仅仅每个字节的 8 个数据位参与生成 CRC, 起始位和停止位以及可能使用的奇偶位都不影响 CRC。在生成 CRC 时, 每个字节的 8 位与寄存器中的内容进行异或, 然后将结果向低位移位, 高位则用“0”补充, 最低位 (LSB) 移出并检测, 如果是 1, 该寄存器就与一个预设的固定值 (0A001H) 进行一次异或运算, 如果最低位为 0, 不作任何处理。

In the CRC operation, a 16-bit register is first preset to all ones, and then 8 bits in each byte in the data frame are successively operated on with the current value of the register, only 8 data bits per byte participate in generating a CRC, and neither the start and stop bits nor the parity bits that may be used affect the CRC. When the CRC is generated, the 8-bit of each byte is XORed with the contents of the register, and then the result is shifted to the low-order bit. The high-order bit is complemented with "0" and the LSB is shifted out and detected. If it is 1, This register is XORed with a preset fixed value (0A001H). If the least significant bit is 0, nothing is done.

CRC 生成流程:

1 预置一个 16 位寄存器为 0FFFFH (全 1), 称之为 CRC 寄存器。

2 把数据帧中的第一个字节的 8 位与 CRC 寄存器中的低字节进行异或运算, 结果存回 CRC 寄存器。

3 将 CRC 寄存器向右移一位, 最高位填 0, 最低位移出并检测。

4 如果最低位移出为 0: 重复第 3 步 (下一次移位); 如果最低位移出为 1: 将 CRC 寄存器与一个预设固定值 (0A001H) 进行异或运算。

5 重复第 3 步和第 4 步直到 8 次移位。这样就处理完了一个完整的 8 位。

6 重复第 2 步到第 5 步来处理下一个 8 位, 直到所有的字节处理结束。

7 最终 CRC 寄存器的值就是 CRC 的值。

此外还有一种利用查表计算 CRC 的方法, 它的主要特点是计算速度快, 但是表格需要较大的存储空间, 该方法此处不再赘述, 请查阅相关资料。

CRC generation process:

1 Preset a 16-bit register to 0FFFFH (all 1s) and call it CRC register.

2 XOR the 8 bits of the first byte in the data frame with the low byte in the CRC register and store the result back in the CRC register.

3 Move the CRC register one bit to the right, fill "0" in the highest bit, and move the lowest bit out and detect it.

4 If the shifted out minimum bit is 0: Repeat step 3 (next shift); if the shifted out minimum bit is 1: XOR the CRC register with a preset fixed value (0A001H).

5 Repeat step 3 and 4 until 8 shifts to complete a complete 8-bit processing.

6 Repeat step 2 to 5 to process the next 8 bits until processing of all byte ends.

7 The final CRC register value is the CRC value.

In addition, there is a method for calculating CRC by using a look-up table. Its main feature is that the calculation speed is fast, but the table needs a large storage space. This method is not described here any more. Please refer to related material.

7.4 Modbus 通讯说明 MODBUS communication description

7.4.1 通信地址表(Word)Communication address table(Word)

RO: 只读 R/W: 读写 RO: Read Only R/W: Read/ Write

地址 Address	名称 Name	类型 Type	备注 Note		word
0	直流电压值 DC voltage value	RO	-9999~9999	读数=有效值 $\times 10^{(\text{小数点}-3)}$ 例: 读到数据为 5000, 小数点为 2, 即实际数据为 $5000 \times 10^{(2-3)} = 500.0$ $\text{Reading} = \text{Effective value} \times 10^{(\text{Decimal point} - 3)}$ For example: When the data is read as 5000 and the decimal point is 2, the actual data is $5000 \times 10^{(2-3)} = 500.0$	1
1	电压小数点(DPT) Decimal Point of Voltage (DPT)	RO	0-9		1
2	直流电流值 DC current value	RO	-9999~9999		1
3	电流小数点(DCT) Decimal Point of Current (DCT)	RO	0-9		1
4	断线检测指示 Broken wire detection indication	RO	1: 断线 0: 未断线 1: Broken 0: Not broken		1
5	内部温度 Internal temperature	RO	-400~1250, 小数点一位, 单位 $^{\circ}\text{C}$ -400~1250, one decimal place, unit $^{\circ}\text{C}$		1
6~7					

8	功率值 Power value	RO	-9999~9999	读数=有效值 $\times 10^{(\text{小数点}-3)}$ Reading = Effective value $\times 10^{(\text{Decimal point } -3)}$	1
9	功率小数点 (DP) Power Decimal Point (DP)	RO	0-10		
10~11	保留 Reserve				1
12~13	总正向有功电能 Total positive active energy	RO	一次侧电能, 单位 WH, 高字节在前, 低字节在后 Primary side energy, unit WH, high byte is first, low byte is later		2
14~15	总反向有功电能 Total reverse active energy	RO	一次侧电能, 单位 WH, 高字节在前, 低字节在后 Primary side energy, unit WH, high byte is first, low byte is later		2
16	电压变比 Voltage transformation ratio	R/W	0001---9999		1
17	额定一次电流值 Primary rated current	R/W	0001---9999		1
18	开关量输入输出状态 Switch input and output status	R/W	详见表后说明 View the table for details		1
19	报警状态 Alarm status	R/W	详见表后说明 View the table for details		1
20	当前总电压百分比 Current total voltage percentage	RO	保留 Reserve		1
21	电压直流含量百分比 DC content percentage of voltage	RO			1
22	电压交流含量百分比 AC content percentage of voltage	RO			1
23	当前总电流当前百分比 Current total current percentage	RO			1
24	电流直流含量百分比 DC content percentage of current	RO			1
25	电流交流含量百分比 AC content percentage of current	RO			1
26	当前总功率百分比 Current total power percentage	RO			1
27	功率直流含量百分比 DC content percentage of power	RO			1

28	功率交流含量百分比 AC content percentage of power	RO		1
29	保留 Reserve	RO		6
30~32	日期时间设置 Date and time settings	R/W	每个字节依次为年月日时分秒，十进制 Each byte in order is in year, month, day, hour, minute, second and is decimal.	6
33 高字节 High byte	当前抄表日 Current meter reading day	RO	1-31	6
33 低字节 Low byte	当前费率 Current rate	RO	0-3 依次为尖峰平谷 0-3 in order is the sharp、peak、shoulder、off-peak	6
34	保留 Reserve			6
35	软件版本号 Software version number	RO		

地址 Address	名称 Name	类型 Type		word
2000~2001	总正向有功电能 Total positive active energy	RO		2
2002~2003	总尖正向有功电能 Total positive active energy(sharp)	RO		2
2004~2005	总峰正向有功电能 Total positive active energy(peak)	RO		2
2006~2007	总平正向有功电能 Total positive active energy(should)	RO		2
2008~2009	总谷正向有功电能 Total positive active energy(off-peak)	RO		2
2010~2011	当前月总正向有功电能 Total positive active energy for the current month	RO		2
2012~2013	当前月尖正向有功电能 Positive active energy for the current month(sharp)	RO		2
2014~2015	当前月峰正向有功电能 Positive active energy for the current month(peak)	RO		2
2016~2017	当前月平正向有功电能 Positive active energy for the	RO		2

备注
单位 WH，高字节在前，低字节在后
0-999999999
Note:
Unit WH, high byte is first, low byte is later
0-999999999

	current month(should)		
2018~2019	当前月谷正向有功电能 Positive active energy for the current month(off-peak)	RO	2
2020-2139	一次为 1-12 月正向复费率电能, 超过等于本月的, 为去年的复费率 Primary positive multi-rate energy for a period of 1-12 months, more than or equal to this month, is the multi-rate of last year		
2140~2141	总反向有功电能 Total reverse active energy	RO	2
2142~2143	总尖反向有功电能 Total reverse active energy(sharp)	RO	2
2144~2145	总峰反向有功电能 Total reverse active energy(peak)	RO	2
2146~2147	总平反向有功电能 Total reverse active energy(should)	RO	2
2148~2149	总谷反向有功电能 Total reverse active energy(off-peak)	RO	2
2150~2151	当前月总反向有功电能 Total reverse active energy for the current month	RO	2
2152~2153	当前月尖反向有功电能 Reverse energy for the current month(sharp)	RO	2
2154~2155	当前月峰反向有功电能 Reverse energy for the current month(peak)	RO	2
2156~2157	当前月平反向有功电能 Reverse energy for the current month(should)	RO	2
2158~2159	当前月谷反向有功电能 Reverse energy for the current month(off-peak)	RO	2
2160-2279	一次为 1-12 月反向复费率电能, 超过等于本月的, 为去年的复费率 Primary reverse multi-rate energy for a period of 1-12	RO	

	months, more than or equal to this month, is the multi-rate of last year			
--	--	--	--	--

地址 (十进制) Address (Decimal)	名称 Name	类型 Type	备注 Note	word
正反向功率、电流需量 Positive and reverse power and current demand				
2280	正向功率需量 Positive power demand	RO	当前月的正向功率需量, 其他类推 The current month's positive power demand, and other is similar	1
2281	需量发生日期 (月、日) Demand occurrence date (month, day)	RO	高字节高四位为年, 低 4 位为月 High 4 bits are year, lower 4 bits are month in high byte	1
2282	需量发生时间 (时、分) Demand occurrence time (hour, minute)	RO		1
2283-2318	同上 Same as above	RO	依次为 1-12 月的正向功率需量记录 1-12 month's positive power demand records in turn	...
2319-2357	反向功率需量 Reverse power demand	RO	依次为当前及 1-12 月反向功率需量记录 Current and 1-12 month's reverse power demand records in turn	...
2358-2396	正向电流需量 Positive current demand	RO	依次为当前及 1-12 月正向电流需量记录 Current and 1-12 month's positive current demand records in turn	...
2397-2435	反向电流需量 Reverse current demand	RO	依次为当前及 1-12 月反向电流需量记录 Current and 1-12 month's reverse current demand records in turn	...
开关量动作事件记录 Event record of switch action				
46	最新一次的开关量事件位置 The latest switch event location	RO	0-9 依次循环, 如果为 0 即 2460 地址, 1 对应 2465 地址, 依次类推。 0-9 cycles in turn, 0 is the address of 2460, 1 is the address of 2465, and so on	1
2460	开关量事件记录 1 Switch event record 1	RO	1.开关量动作记录, bit15 为 1 表示闭合, 为 0 表示断开; bit12-bit8 为 1 表示 DO, 为 3 表示 DI, 低 8 位为 1 表示第 1 路 例: 0x8102,表示第 2 路 DO 闭合, 0x0102, 表示第 2 路 DO 断开。 2.动作时的告警状态, 见告警状态寄存器 1.Switching action record, bit15 is 1 means closed, 0 means disconnected; bit12-bit8 is 1 means DO, 3 means DI, and lower 8 bit is 1 means 1st way. For example: 0x8102	1
2461	开关量事件时报警状态 Alarm status at switching events	RO		1
2462	开关量事件 (年月) Switch event (Year、month)	RO		1
2463	开关量事件 (日時) Switch event (Day、hour)	RO		1

2464	开关量事件（分秒） Switch event (Minute、second)	RO	means DO2 is closed, 0x0102 means DO2 is disconnected. 2.View alarm status register for alarm status during operation	1
2465-2539	开关量事件记录 2-16 组 Switch event records of group 2-16		同上 Same as above	
继电器一 Relay outputs one				
608	设置 DO 输出类型 sets the DO output type	R/W	“0. do”表示为通信控制（此时如果 DLY 设置为 0 输出为电平方式，否则为脉冲方式，如果 DLY 设置为 2，吸合后 0.02 秒自动断开），其他为报警控制 “0. do” means communication control. (If DLY is set to 0, the output is in level mode , otherwise it is in pulse mode. If DLY is set to 2, automatic shutdown will take 0.02 seconds after pull in. Open)	1
609	输出延时时间 Output delay time	R/W	如果为 DO 输出方式，设置为 0 时，为电平控制方式，非 0 时为脉冲控制方式，延时设置的时间后断开，延时设置范围 1—255 时，单位：0.01 秒；如果为报警输出方式，延时设置范围 1—9999 时，单位：1 秒； If it is DO output mode, when it is set to 0, it is the level control mode; when it is not 0, it is the pulse control mode, and is disconnected after the setted delay time, the delay setting range is 1-255, unit: 0.01 seconds; if it is alarm output mode, delay setting range is 1-9999, unit: 1 second;	1
610	不动作带区间 Non action band	R/W		1
611	电压高报警，按百分比进行设置 High voltage alarm, set by percentage	R/W		1
612	电压低报警，按百分比进行设置 Low voltage alarm, set by percentage	R/W		1
613	电流高报警，按百分比进行设置 High current alarm, set by percentage	R/W		1

614	电流低报警，按百分比进行设置 Low current alarm, set by percentage	R/W		1
615	功率高报警，按百分比进行设置 High power alarm, set by percentage	R/W		1
616	功率低报警，按百分比进行设置 Low power alarm, set by percentage	R/W		1
617	手动复位/零报警使能 Manual reset/Zero alarm enable	R/W	高字节：手动复位 低字节：零报警使能 high byte: Manual reset low byte: Zero alarm enable	
继电器二 Relay outputs two				
618	设置 DO 输出类型 sets the DO output type	R/W		1
619	输出延时时间 Output delay time	R/W		1
620	不动作带区间 Non action band	R/W		1
621	电压高报警，按百分比进行设置 High voltage alarm, set by percentage	R/W		1
622	电压低报警，按百分比进行设置 Low voltage alarm, set by percentage	R/W		1
623	电流高报警，按百分比进行设置 High current alarm, set by percentage	R/W		1
624	电流低报警，按百分比进行设置 Low current alarm, set by percentage	R/W		1
625	功率高报警，按百分比进行设置 High power alarm, set by percentage	R/W		1
626	功率低报警，按百分比进行设置 Low power alarm, set by percentage	R/W		1

	Low power arm, set by percentage		
627	手动复位/零报警使能 Manual reset/Zero alarm enable	R/W	1

7.4.2 说明:

- ① 电压、电流、功率等数据数值计算方法: (例见: 7.5.1 读数据)
 读数 = 有效值 × 10^(指数位-3)

Description:

- ① Calculation method of Voltage, current, power and other data :(example: 7.5.1 read data)
 Reading = Effective value × 10^(Index -3)

18:开关量输入/ 输出状态字: Switch input/output status word:

15	...	10	9	8	7	...	2	1	0
---		Di2	Di1	---				Do2	Do1
保留 Reserve		开关量输入 Switch input		保留 Reserve				开关量输出 Switch output	

19:报警状态字: Alarm status word:

15	...	8	7	6	5	4	3	2	1	0
---		DI2	DI1	L-P	H-P	L-I	H-I	L-U	H-U	
同低 8 位的状态 Same as the low 8 bits		第 2 路开关量输入 No. 2 switch input	第 1 路开关量输入 No. 1 switch input	欠功率 Under power	过功率 Over power	欠流 Under current	过流 Over current	欠压 Under voltage	过压 Over voltage	
DO2 告警状态 DO2 alarm status		DO1 告警状态 DO1 alarm status								

说明:

- ① “---” 表示保留字或保留位。
 ② 警标志位: 1 为有报警, 0 为无报警。

Description:

- ① "-" indicates a reserved word or reserved bit.
 ② Warning flag: 1 for alarm, 0 for no alarm.

7.5 通讯应用 Communication application

本节所举实例尽可能采用下表格式 (数据为 16 进制)

The examples in this section use the following table format as far as possible (the data is in hexadecimal)

Addr	Fun	Data Start		Data#of		CRC 16	
		reg Hi	reg Lo	reg Hi	reg Lo	Lo	Hi
01H	03H	00H	00H	00H	06H	C5H	C8H
地址 Address	功能码 Function code	数据起始位 Data start bit		数据读取个数 Number of data read		循环冗余校验码 Cyclic redundancy check code	

例 1: 读电流数据

Example 1: Reading current data

查询数据帧 Query data frame	01 03 00 02 00 02 65 cb
返回数据帧 Return data frame	01 03 04 03 b2 00 00 5a 50

说明:

01: 从机地址

03: 功能码

04: 十六进制, 十进制为 4, 表示后面有 4 个字节的数
Hexadecimal, decimal is 4, indicates that the following 4 bytes of data

5a 50: 循环冗余校验码

处理如下: 03 b2(16 进制) = 946 (10 进制电流数据)

00 00(16 进制) = 0 (10 进制小数点数据)

计算: $946 \times 10^{-3} = 0.946$; 单位: 安培 (A)

则仪表显示:

I=0.946

读电压表数据与读电流表类似, 但起始地址为 00H,

查询帧: 01 03 00 00 00 02 c4 0b

读其它信息的查询帧与此格式相同, 各信息地址见通讯参量地址表。

注: 电压、电流、功率的有效数据与指数位均为有符号数据, 若一数读为“FFFF”, 则表示该数据为“-1”

Description:

01: Slave address

03: Function code

04: Hexadecimal, decimal is 4, indicates that the following 4 bytes of data

5a 50: Cyclic Redundancy Check Codes

The processing is as follows:

03 b2 (hexadecimal) = 946 (decimal current data)

00 00 (hexadecimal) = 0 (decimal data)

Calculation: $946 \times 10^{-3} = 0.946$; Unit: Ampere (A)

The meter displays:

I=0.946

Reading voltage data is similar to reading current, but the starting address is 00H, query frame: 01 03 00 00 00 02 c4 0b.

The query frame for reading other information is the same as this format, and each information address is in the communication parameter address table.

Note: The valid data and exponent bits of voltage, current, and power are both signed data. If a number is read as “FFFF”, it means the data is “-1”.

总部：安科瑞电气股份有限公司
地址：上海市嘉定区马东工业园育绿路 253 号
电话：021-69158300 69158301 69158302
传真：021-69158303
服务热线：800-820-6632
网址：www.acrel.cn
邮箱：ACREL001@vip.163.com
邮编：201801
Address: Yulv Road 253, Madong Industrial Park, Jiading, Shanghai
Fax: (86)21-69158303
Service hotline: 800-820-6632
Website: www.acrel.cn
E-mail: ACREL001@vip.163.com
P.C.: 201801

生产基地：江苏安科瑞电器制造有限公司
地址：江阴市南闸街道东盟路 5 号
电话（传真）：（86）0510-86179970
邮编：214405
邮箱：JY-ACREL001@vip.163.com
Production base: Jiangsu Acrel Electric Appliances Manufacturing Co., Ltd,
Address: Dongmeng Road 5, Nanzha Street, Jiangyin City
Tel./fax: (86)0510-86179970
P.C.: 214405
E-mail: JY-ACREL001@vip.163.com

更改记录：

V1.1: 增加电表实际端子位置图示

V1.2: 增加分流器接负端接线图，同时在菜单编程界面增加 ~~0E9E~~ 设置选项

V1.3: 1.更改电流霍尔部分接线图，第二路霍尔输入不能用电表内置电源，需外配；
2. 菜单新增电压、电流零点屏蔽功能。

V1.4: 增加四线制接法

V1.5: 增加电流输入信号线推荐使用 0.75mm² 或 1mm² 屏蔽双绞线，屏蔽层接大地

V1.6: 1.增加电压、电流输入的二次弱信号线推荐使用 0.75mm² 或 1mm² 屏蔽双绞线，且屏蔽层需要接大地
2.修改仪表第一个按键由 ESC 改为 SET,修改端子号。

V1.7.: 1.增加继电器一和继电器二的通讯地址
2.修改技术参数的环境温度和操作界面错误的数值
3.辅助功能 K/2C 改为二选一
4.增加通讯菜单