

014



# BD 系列电力变送器

Series BD electric transmitters

安装使用说明书 V1.4

Installation and Operation Instruction V1.4

安科瑞电气股份有限公司

Acrel Co., Ltd.

# 申 明

## DECLARATION

版权所有，未经本公司之书面许可，此手册中任何段落，章节内容均不得被摘抄、拷贝或以任何形式复制、传播，否则一切后果由违者自负。

本公司保留一切法律权利。

No part of this publication may be reproduced, stored in a retrieval system, or transmitted in any form by any means, electronic, mechanical photocopying, recording, or otherwise without prior permission of Acrel. All rights reserved.

本公司保留对本手册所描述之产品规格进行修改的权利，恕不另行通知。

订货前，请垂询当地代理商以获悉本产品的最新规格。

This company reserve power of revision of product specification described in this manual, without notice. Before ordering, please consult local agent for the latest specification of product.

# 目 录

## CONTENTS

1 概述 General.....	1
2 型号说明 Type explanation.....	1
4 产品型号 Type of products.....	3
4.1 电流、电压变送器 Current, voltage transmitters.....	3
4.2 三相电流、电压变送器 Three-phase current, voltage transmitters.....	4
4.3 热电阻变送器 RTD transmitters.....	5
4.4 智能温度变送器 Intelligent temperature transmitters.....	6
4.5 功率变送器 Power transmitters.....	7
4.6 功率因数变送器 Power factor transmitters.....	9
4.7 频率变送器 Frequency transmitters.....	9
4.8 多电量数字变送器 Multi-electrical parameters digital transmitters.....	10
5 操作指南 Operating guide.....	12
5.1 查看状态 View Status.....	12
5.2 操作字符说明 Operation character Description.....	13
5.3 系统设置模式 System setting mode.....	13
6 通讯指南 Communication guide.....	15
6.1 通讯 Communication.....	15
6.2 MODBUS 协议简述 MODBUS protocol compendium.....	15
6.3 查询—回应周期 Query-respond period.....	15
6.4 传输方式 Transmission mode.....	16
6.5 协议 Protocol.....	17
6.6 错误检测的方法 Method to create error check code(CRC).....	18
6.7 通讯应用格式详解 Communication apply format expound.....	19
7 订货实例 Order example.....	27
7.1 BD-AI 接线实例 BD-AI Connection example.....	27
7.2 BD-3I3 接线实例 BD-3I3 Connection example.....	28
7.3 BD-3V3 接线实例 BD-3V3 Connection example.....	29
7.4 BD-PF 接线实例 BD-PF Connection example.....	30
7.5 BD-4P 接线实例 BD-4P Connection example.....	31
7.6 BD-4E 接线实例 BD-4E Connection example.....	32
7.7 通讯接线实例 Connected mode in communication.....	33

## 1 概述 General

BD 系列电力变送器是一种将电网中的电流、电压、频率、功率、功率因数等电参量，经隔离变送成线性的直流模拟信号或数字信号装置。产品符合 GB/T13850-1998、IEC-688 标准。

Series BD electric transmitters is a device which can isolate and transmit electric parameters, such as current, voltage, frequency, power, power factor, into linear DC analog signal or digital signal. It meet the requirements of National standard GB/T13850-1998, IEC-688.

## 2 型号说明 Type explanation

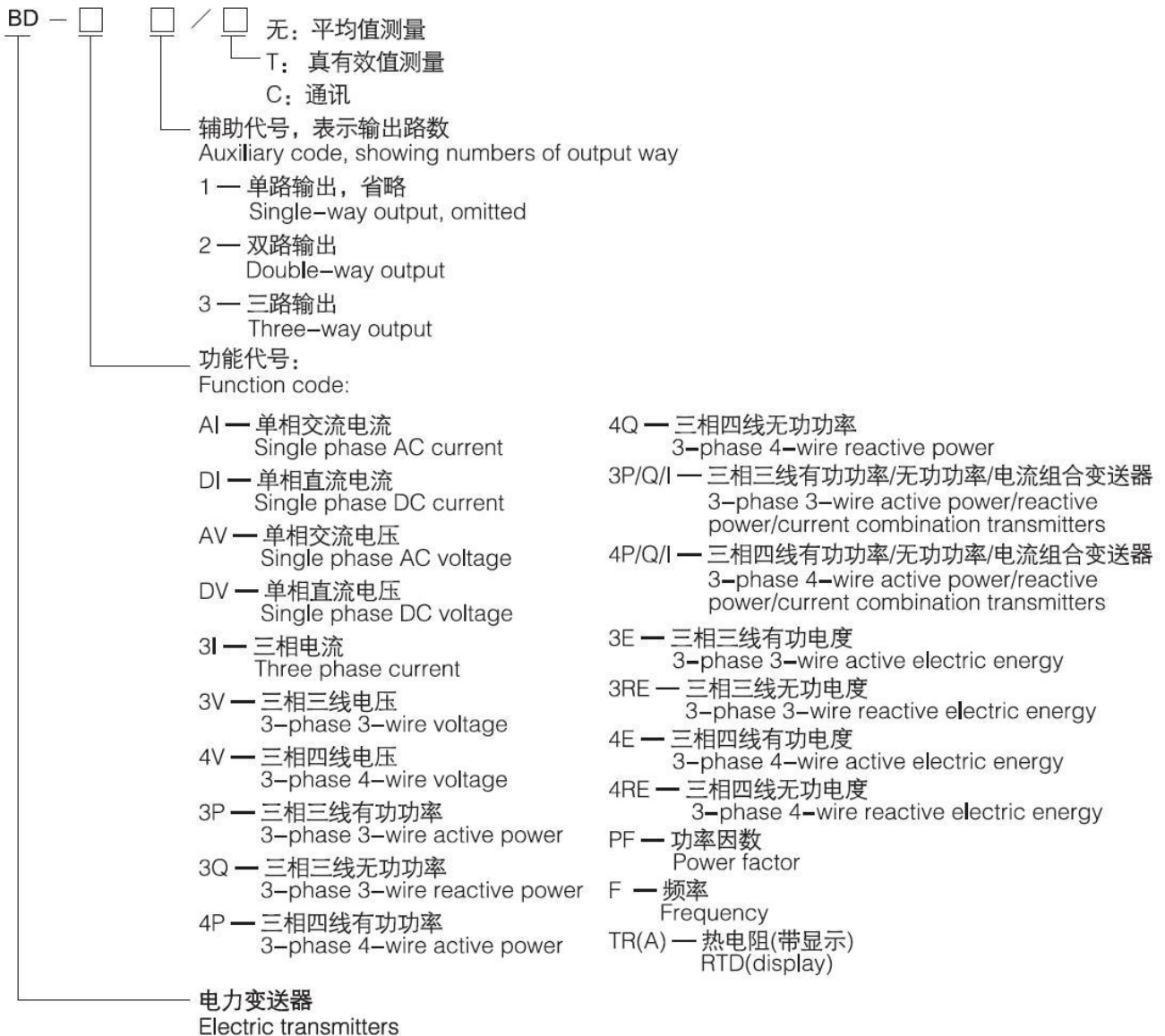

### 3 通用技术条件 General technical condition

技术参数 Technical parameters		指标 Value
精度等级 Accuracy class		0.5、0.2
输入 Input	标称值 Nominal value	电流(Current)AC、DC 1A、5A; 电压(Voltage)AC、DC 100V、300V、500V 等
	过载 Overload	持续 1.2 倍, 瞬时电流 10 倍/5 秒; 瞬时电压 2 倍/30 秒 Continual 1.2 times, Instantaneous current 10 times/5s; Instantaneous voltage 2 times/30s;
	吸收功率 Consumption	≤0.3VA(电流输入 Current input); 电压输入 Voltage input, ≤0.3VA(100V 时), ≤0.6VA(300V 时), ≤1VA(500V 时)
	频率 Frequency	50±5Hz, 60±5Hz
输出 Output	标称值 Normal value	DC:4-20mA、0-20mA, 0-5V, 0-10V 等(And so on)
	负载电阻 Load resistance	电流输出时(Current output)≤600 Ω 电压输出时(Voltage output)≥1000 Ω
	纹波含量 Ripple content	<0.5%峰值(peak value)
响应时间 Response time		≤400ms
电源 Power supply	电压 Voltage	AC85-265V、DC100-350V
	功耗 Consumption	交流电流, 电压类(AC current, voltage)≤3VA, 功率类(Power)≤4VA
绝缘电阻 Insulation resistance		≥100M Ω
耐压强度 Isolation voltage		输入//输出//电源之间(Among input//output//power supply) 2.0kV/1min, 50Hz
温度系数 Temperature modulus		≤200ppm/°C
环境 Environment	温度 Temperature	工作(Work): -10°C~+55°C 存贮(Storage): -25°C~+70°C
	湿度 Humanity	≤90%RH, 不结露, 无腐蚀性气体场所 (In the place without dew and corrosive gas)
	海拔 Altitude	≤2000m
安装方式 Fix mode		TS35 导轨, 或用螺钉固定柜体上 (Rail, or fix to cubicle with bolt)

## 4 产品型号 Type of products

### 4.1 电流、电压变送器

#### 4.1 Current, voltage transmitters

- 用途  
测量电流、电压信号，隔离变送输出模拟信号。
- Usage  
Measure current, voltage signal, isolate and transmit analog signal output.
- 产品规格  
BD-AI 交流电流变送器  
BD-DI 直流电流变送器  
BD-AV 交流电压变送器  
BD-DV 直流电压变送器  
BD-AI/C 交流电流变送器，带通讯功能  
BD-AV/C 交流电压变送器，带通讯功能

注：BD-AI/T、BD-AV/T 采用真有效值测量电路，可对各种正弦或非正弦波正确测量。适用在变频环境中。

- Specification  
BD-AI AC current transmitters  
BD-DI DC current transmitters  
BD-AV AC voltage transmitters  
BD-DV DC voltage transmitters  
BD-AI/C AC current transmitters  
With communication function  
BD-AV/C AC voltage transmitters  
With communication function

Note: BD-AI/T, BD-AV/T adopts effective value measuring circuit, and can measure various sine wave or non-sine wave correctly.

- 外形尺寸
- Outline dimension

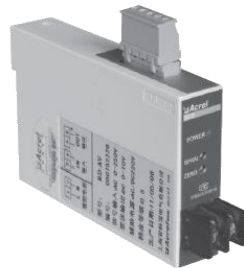
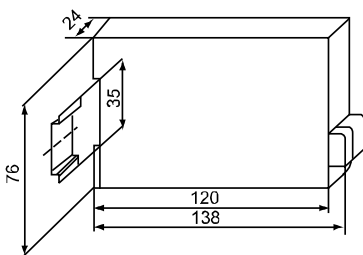

- 接线方式
- Wiring

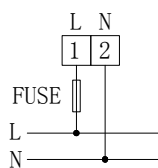

辅助电源: AC 85~265V DC 100~350V

AC 85~265V DC 100~350V Auxiliary power supply

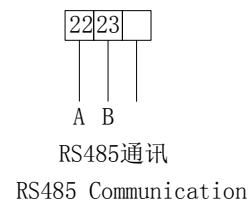
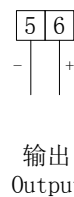
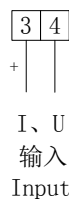

- 订货范例  
例 型 号: BD-AI

辅助电源: AC220V/50Hz

输入: 5A

输出: 4~20mA

■ Order example

E.g. Type: BD-AI

Auxiliary power supply: AC220V/50Hz

Input: 5A

Output: 4~20mA

注: 仅仪表 BD-AI、BD-AV 可带 RS485 通讯功能。

### 4.2 三相电流、电压变送器

#### 4.2 Three-phase current, voltage transmitters

■ 用途

测量三相电流、电压信号, 隔离变送输出三路模拟信号。

■ Usage

Measure three-phase current or voltage, isolate and transmit 3-channel analog output.

■ 产品规格

BD-3I3 三相电流变送器

BD-3V3 三相三线电压变送器

BD-4V3 三相四线电压变送器

■ Specification

BD-3I3 Three-phase current transmitters

BD-3V3 Three-phase 3-wire voltage transmitters

BD-4V3 Three-phase 4-wire voltage transmitters

■ 外形尺寸

■ Outline dimension

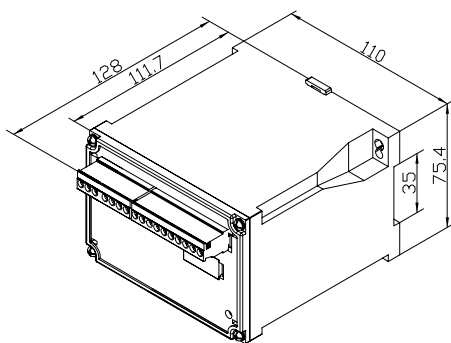

■ 接线方式

■ Wiring

电流变送器

Current transmitters

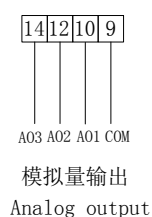
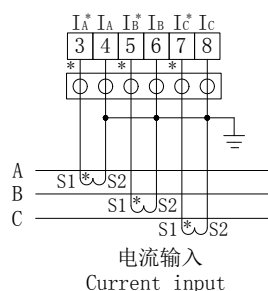
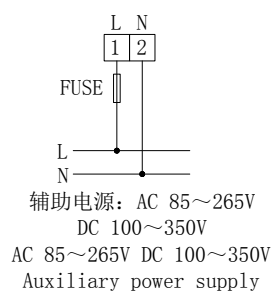

## 电压变送器

### Voltage transmitters

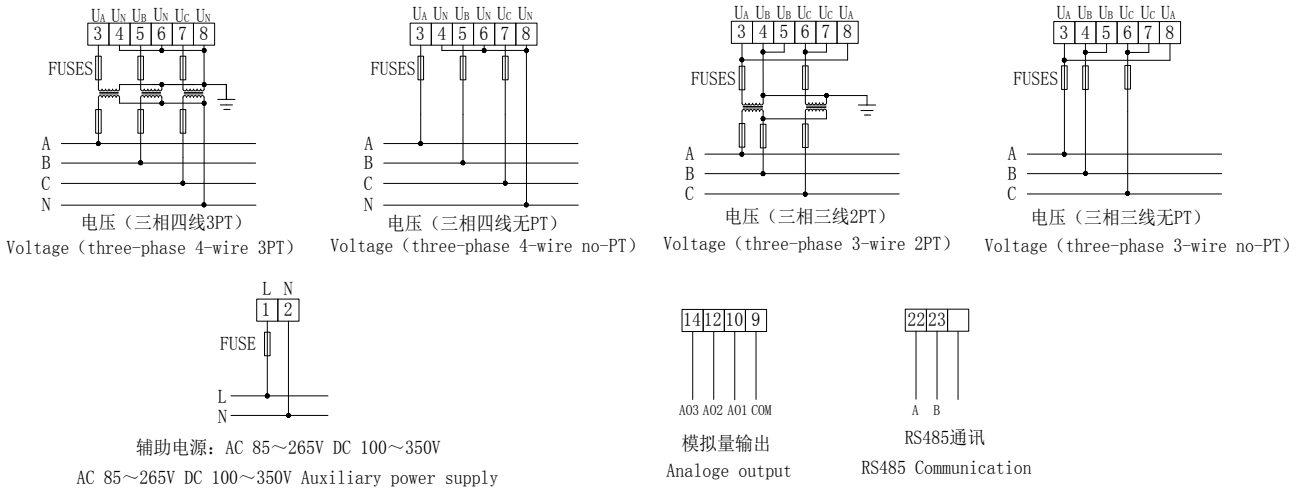

#### ■ 订货范例

例 型 号: BD-3I3

辅助电源: AC220V/50Hz

输 入: 5A

输 出: 三相 4~20mA

#### ■ Order example

E.g. Type: BD-3I3

Auxiliary power supply: AC220V/50Hz

Input: 5A

Output: 3-channel 4~20mA

### 4.3 热电阻变送器

#### 4.3 RTDtransmitters

##### ■ 用途

RTD 输入, 比例输出 2000V 隔离的 DC(4-20mA, 0-20mA, 0-5V 或 0-10V)信号。模块内具有浪涌保护电路, 也适用于恶劣的环境工作。

##### ■ Usage

The module have features of power supply by output circuit, RTD input, 4~20mA signal output to be isolated from 2000V, fitted with surge protection circuit , so fits for foul environment.

##### ■ 产品规格

BD-TR/I, BD-TR/V

##### ■ Specification

BD-TR/I, BD-TR/V

##### ■ 外形尺寸

##### ■ Outline dimension

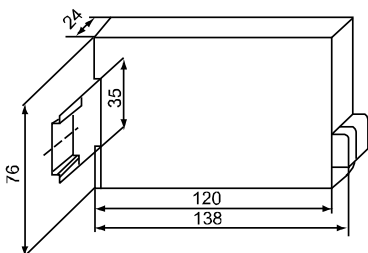



■ 接线方式

■ Wiring

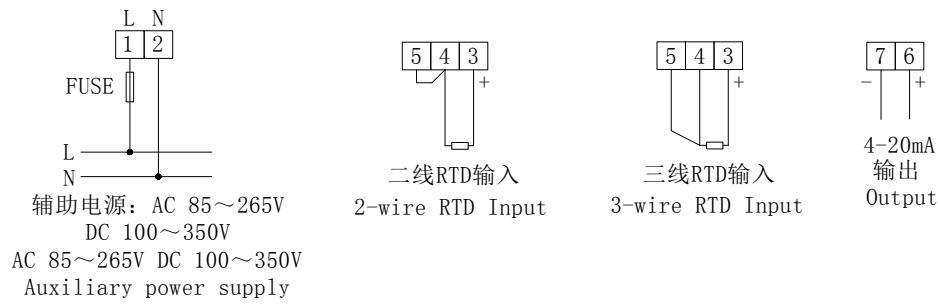

■ 订货范例

例 型 号: BD-TR/I

辅助电源: AC220V/50Hz

输 入: PT100 0~200℃

输 出: 4~20mA

■ Order example

E.g. Type: BD-TR/I

Auxiliary power supply: AC220V/50Hz

Input: PT100 0~200℃

Output: 4~20mA

4.4 智能温度变送器

4.4 Intelligent temperature transmitters

■ 用途

输入信号为热电阻(PT100),并带有温度显示功能,经隔离转换成标准的模拟量(4-20mA 或 0-20mA 或 0-5V 或 0-10V)输出,既可直接与指针表、数显表相接,也可以与自控仪表(如 PLC)、各种 A/D 转换器、以及计算机系统配接。

■ Usage

RTDinput and temperature display function, isolate and transmit into standard analog output (4-20mA or 0-20mA or 0-5V or 0-10V). It can directly connect pointer digital display meters, and matches with automation meters (PLC), kinds of A/D converter, computer system.

■ 产品规格

BD-TRA 智能温度变送器

■ Specification

BD-TRA intelligent temperature transmitters

■ 外形尺寸

■ Outline dimension

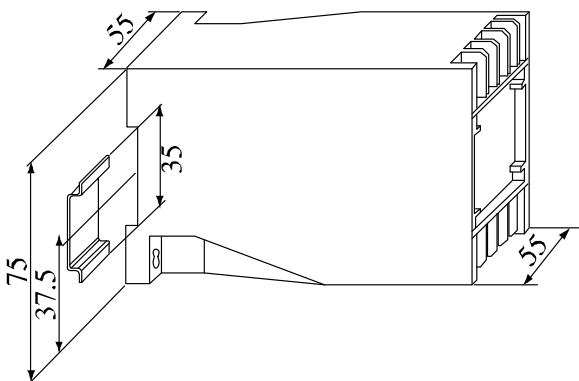

■ 接线方式

■ Wiring

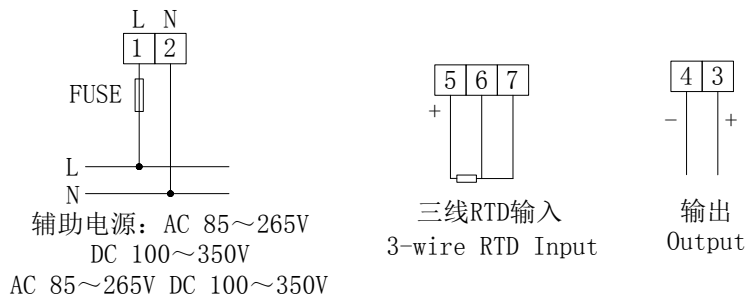

■ 订货范例

例 型 号: BD-TRA

辅助电源: AC220V/50Hz

输 入: PT100 0~200℃

输 出: 4~20mA

■ Order example

E.g. Type: BD-TRA

Auxiliary power supply: AC220V/50Hz

Input: PT100 0~200℃

Output: 4~20mA

4.5 功率变送器

4.5 Power transmitters

■ 用途

能测量有功功率, 无功功率, 隔离变送输出模拟信号。

■ Usage

Measure active power, reactive power, isolate and transmit analog output.

■ 产品规格

BD-3P 三相三线有功功率变送器

BD-3Q 三相三线无功功率变送器

BD-3P/Q/I 三相三线有功功率/无功功率/电流组合变送器

BD-4P/Q/I 三相四线有功功率/无功功率/电流组合变送器

BD-4P 三相四线有功功率变送器

BD-4Q 三相四线无功功率变送器

■ Specification

BD-3P Three-phase 3-wire active power transmitters

BD-3Q Three-phase 3-wire reactive power transmitters

BD-3P/Q/I Three-phase 3-wire active power/reactive power/current combination transmitters

BD-4P/Q/I Three-phase 4-wire active power/reactive power/current combination transmitters

BD-4P Three-phase 4-wire active power transmitters

BD-4Q Three-phase 4-wire reactive power transmitters

■ 外形尺寸

■ Outline dimension

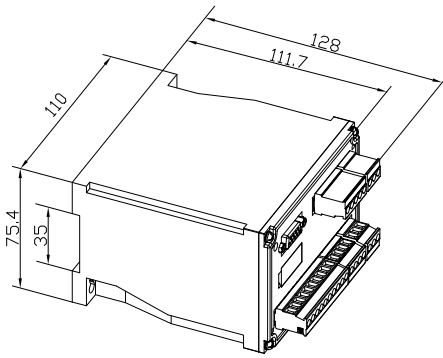

■ 接线方式  
■ Wiring

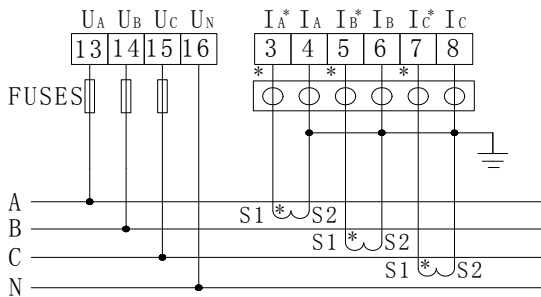

三相四线3CT  
Three-phase 4-wire 3CT

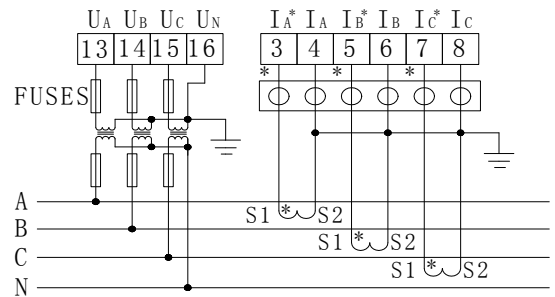

三相四线3PT、3CT  
Three-phase 4-wire 3PT, 3CT

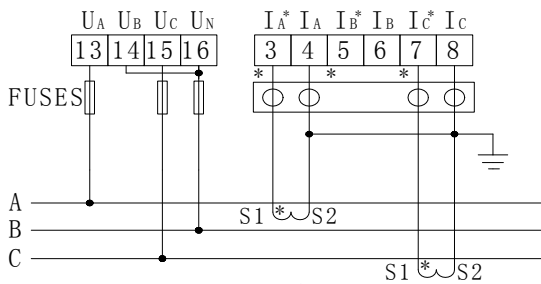

三相三线2CT  
Three-phase 3-wire 2CT

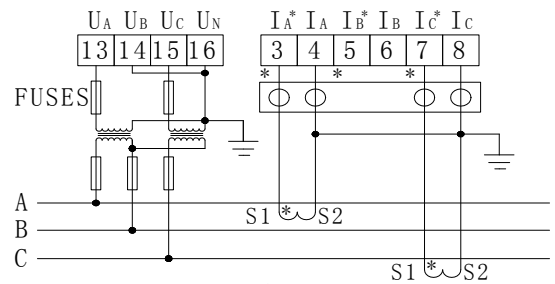

三相三线2PT、2CT  
Three-phase 3-wire 2PT, 2CT

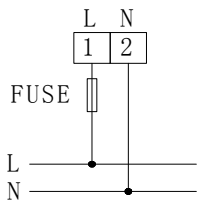

辅助电源  
Auxiliary power supply

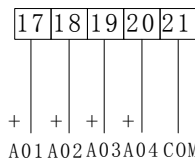

P/Q/I模拟量输出  
P/Q/I Analog output



RS485通讯  
RS485 Communication

■ 订货范例

例 型 号: BD-3P

辅助电源: AC220V/50Hz

输 入: 电流 5A 电压 100V 功率 866W

输 出: 4~20mA 对应 0~866W

■ Order example

E.g. Type: BD-3P

Auxiliary power supply: AC220V/50Hz

Input: Current/5A Voltage/100V Power/866W

Output: 4~20mA corresponds 0~866W

## 4.6 功率因数变送器

### 4.6 Power factor transmitters

#### ■ 用途

用于测量单、三相系统的功率因数，经隔离变换成直流信号输出，供远动装置，计算机，自动化控制系统作信息输入，广泛应用于电力系统场合。

#### ■ Usage

Measure power factor of single, three-phase system, isolate and transmit into DC signal output. It is used for information input of telemechanism, computer, automation control system. It is widely used in electric power system.

#### ■ 产品规格

BD-PF

#### ■ Specification

BD-PF

#### ■ 外形尺寸

#### ■ Outline dimension

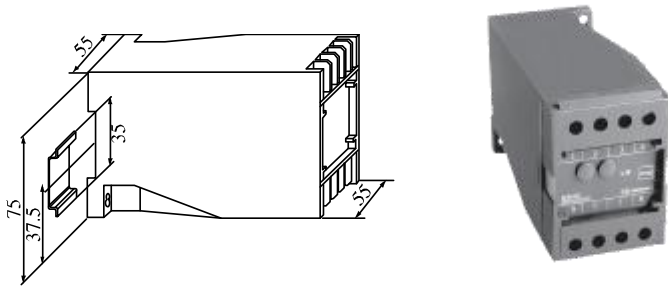

#### ■ 接线方式/Wiring

#### ■ Wiring

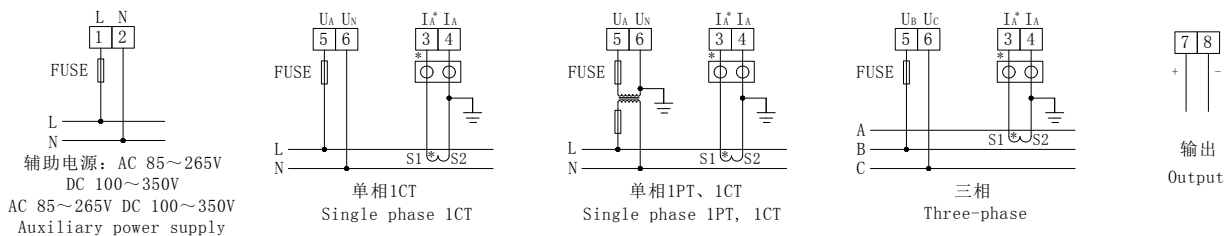

#### ■ 订货范例

例 型 号: BD-PF

辅助电源: AC220V/50Hz

输 入: 电流 5A 电压 100V

输 出: 4~20mA 对应 0~1

#### ■ Order example

E.g. Type: BD-PF

Auxiliary power supply: AC220V/50Hz

Input: Current/5A Voltage/100V

Output: 4~20mA corresponds 0~1

## 4.7 频率变送器

### 4.7 Frequency transmitters

#### ■ 用途

可测量工频频率，将频率变换为线性输出的直流信号，隔离输送给远动装置、计算机、巡检等。

■ Usage

Measure frequency, transmit frequency into linear DC signal output, then isolate and deliver to telemechanics device, computer and so on.

■ 产品规格

BD-F

■ Specification

BD-F

■ 外形尺寸

■ Outline dimension

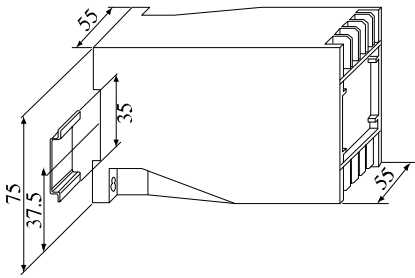

■ 接线方式

■ Wiring

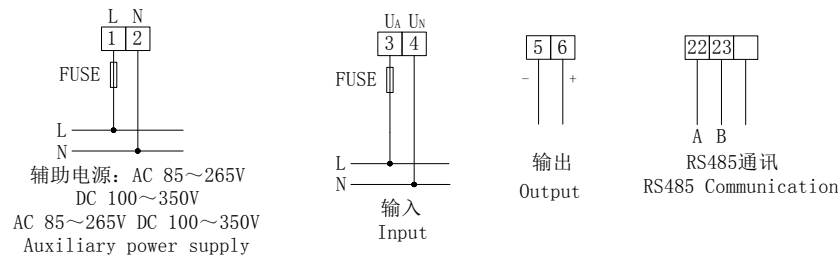

■ 订货范例

例 型 号: BD-F

辅助电源: 220V/50Hz

输 入: 100V

输 出: 4~20mA 对应 45~50~55Hz

■ Order example

E.g. Type: BD-F

Auxiliary power supply: 220V/50Hz

Input: 100V

Output: 4~20mA Corresponds 45~50~55Hz

4.8 多电量数字变送器

4.8 Multi-electrical parameters digital transmitters

■ 用途

将电力系统中的电度量转换成高线性比例输出的脉冲量。该变送器带 RS485 通讯接口，采用 Modbus 协议，可输出三相电流、电压、有功功率、无功功率、频率、功率因数、有功电度、无功电度等数字量，1~4 路模拟量可选，两路电能脉冲输出。

■ Usage

Transmit kWh value of electric power system into high linear pulse. It has RS485 communication interface, adopts Modbus protocol, and exports three-phase current, voltage, active power, reactive power, frequency, power factor, active energy reactive energy and so on. 1~4 channel analog optional, two channel electric energy pulse

output.

■ 产品规格

- BD-3E 三相三线多电量数字变送器
- BD-4E 三相四线多电量数字变送器
- BD-4EA 组合式多功能电力仪表, 外接显示头

■ Specification

- BD-3E Three-phase 3-wire Multi-electrical parameters digital transmitters
- BD-4E Three-phase 4-wire Multi-electrical parameters digital transmitters
- BD-4EA Combined multi-functional power meters

■ 外形尺寸

■ Outline dimension

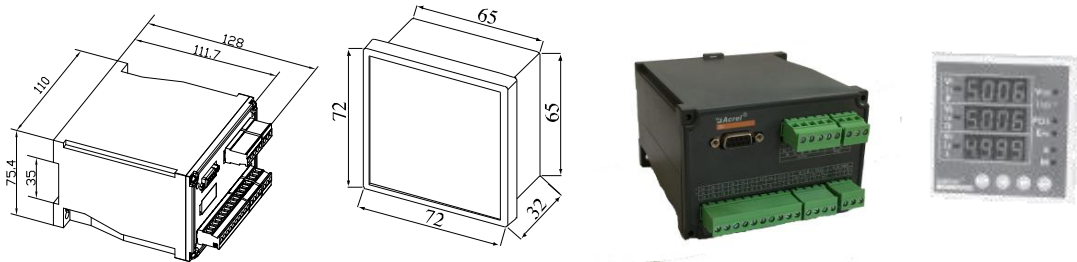

■ 接线方式

■ Wiring

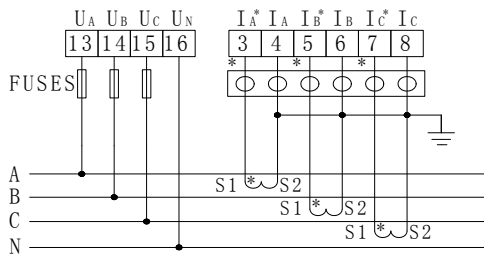

三相四线 3CT  
Three-phase 4-wire 3CT

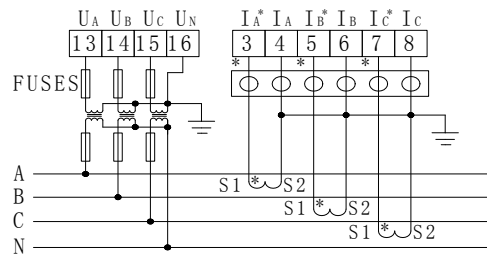

三相四线 3PT, 3CT  
Three-phase 4-wire 3PT, 3CT

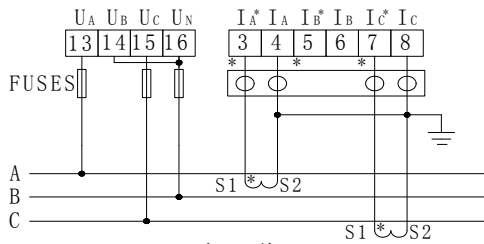

三相三线 2CT  
Three-phase 3-wire 2CT

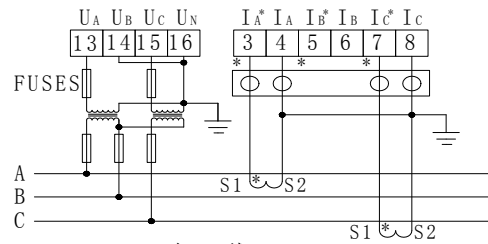

三相三线 2PT, 2CT  
Three-phase 3-wire 2PT, 2CT

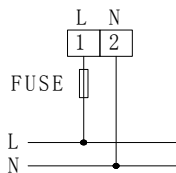

辅助电源  
Auxiliary power supply

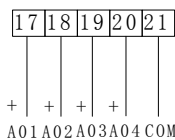

P/Q/I模拟量输出  
P/Q/I Analog output

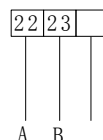

RS485通讯  
RS485 Communication

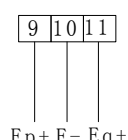

电能脉冲  
Electric energy pulse

例: 输入信号为 AC 100V 5A 时, 4路变送输出对应关系

E.g. Input signal is AC 100V 5A, 4-channel transmitting output corresponding relation

变送输出 Transmitting output	测试对象(26个) Measuring object	对应关系 Corresponding relation
A01	P	4-20mA 对应 0-866W

AO2	Q	4-20mA 对应 0-866var
AO3	Ia	4-20mA 对应 0-5A
AO4	PF	4-20mA 对应 0-1

■ 订货范例

例 型 号: BD-3E

辅助电源: 220V/50Hz

输 入: 电流 5A 电压 100V 功率 866W

输 出: 40000 脉冲/kWh

■ Order example

E.g. Type: BD-3E

Auxiliary power supply: 220V/50Hz

Input: Current/5A Voltage/100V Power/866W

Output: 40000 pulse/kWh

注: BD-4EA 组合式多功能电力仪表主要适合于 GCK、GCS、MNS 等低压抽屉柜的出线回路中, 特别是电器元件排列较为紧凑的场合。产品由信号采集处理部分(即 BD-4E)和显示器组成, BD-4E 安装在内部导轨上, 显示器安装在柜体面板上。功能与 ACR220E 一致。

Note: DT 80-E single-phase active electric energy meters are mainly suitable in the outlet circuits of low voltage draw-out cubicles such as GCK, GCS, MNS etc., particularly used for position with electrical components layout in more compact condition. It consists of BD-4E for acquiring and treating signal, displays. BD-4E is mounted onto the inner guide rail, the display is mounted onto the face place of cubicle. Its function is identical with that of ACR 220E

## 5 操作指南 Operating guide

依照说明正确接线后, 接通工作电源即进入测量状态。

After as per description and correct connection, switching-on working power supply, then enter the measuring condition.

### 5.1 查看状态 (查看电流、电压、功率和电度和频率)

在测量状态下, 单击相应功能键可以依次切换查看: 电压 V、电流 I、有功功率、无功功率、功率因数、有功电度  $E_p$  和无功电度  $E_q$  及频率。

■ 电压显示一次侧值, 单位为 V, 当一次测电压达到预定界限时, 显示单位转换为 kV。

■ 电流显示一次侧值, 单位为 A, 当一次测电流达到预定界限时, 显示单位转换为 kA。

■ 功率显示一次侧值, 有功功率单位为 W, 无功功率单位为 Var, 当功率值达到预定界限时, 显示单位转换为 kW 或者 MW 和 kVar 或者 MVar, 当接线方式为三相四线时, 如果出现某相有功功率或功率因数为负值, 则有可能该相电流进线与出线接反。

■ 显示电度为一次侧值, 电度显示的单位固定为 kWh, 当显示电度时, 显示两位小数, 即精确到 0.01 kWh。

#### 5.1 View Status (View current, voltage, power and electric energy and frequency)

Under measuring condition click corresponding function key, switching View orderly: voltage V, frequency, current I, power PQS, power factor, switching input/output status, active electric energy  $E_q$  and reactive electric energy  $E_q$  and time.

■ voltage display primary side value, unit: V, when primary side voltage reached preset bound, display unit convert as kV.

■ current display primary side value, unit: A, when primary side current reached preset bound, display unit convert as kA.

■ power display primary side value, active power unit: W, reactive power unit: Var, when power value reached preset bound, display unit convert as kW or MW and kVar or MVar, when connection mode as four wire three phase, if active power or power factor of one phase is negative value, it is possible that connection of current inlet and outlet of this phase is just reversal.

■ display electric energy as secondary side value, electric energy display unit only as kWh, when display

electric energy, it should be expressed with two decimal points, i.e. with accuracy to 0.01 kWh.

## 5.2 操作字符说明

### 5.2 Operation character Description

字符 Character	文字说明 Textual description	字符 Character	文字说明 Textual description
PASS	密码 Password	InCt	电流网络 Current network
Addr	地址 Address	In-I	输入电压范围 Input current range
bAUd	波特率 Baud rate	Ct	电流倍率 Current magnification
UnEt	电压网络 Voltage network	Tr-x(x=1,2,3,4)	变送输出设置 Transmitting output setting
L3.3	三相三线 Three phase three wire	SYS	系统设置 System setting
L3.4	三相四线 Four wire three phase	CodE	设置密码 Setting password
In-U	输入电压范围 Input voltage range	CLr.E	电能清零 Electric energy zero clearing
Pt	电压倍率 Voltage magnification		

## 5.3 系统设置模式

### 5.3 System setting mode

#### 5.3.1 进入/退出系统设置模式

在正常情况下，仪表处于正常工作状态，按下 SET 键，再按回车键会进入系统设置模式，进入系统设置模式前，首先需要输入正确的密码 PASS（出厂时设置为 0001）。

输入密码的方法为：

(1)按 SET 键，再按回车键进入输入密码状态；

(2)按左右方向键减小或增大数值大小至正确的密码(可以同时按左或右方向键+回车键即可实现对百或十位数字的减小或增大)；

(3)按回车键确认数据进入系统设置模式。

■如果密码输入正确，即进入系统设置模式。

■仪表出厂时密码设置为 0001。

■在系统设置模式下，任何时候连续单击 SET 键都能退出系统设置模式并询问是否保存设置（按回车键保存，按 SET 键不保存，按其他键继续设置）后返回到测量状态。

■系统设置模式下的各项目都被存储在存储器中，一旦设置成功，再次设置前，一直有效。

#### 5.3.1 Enter/Exit system setting mode

Under normal condition, meter is in normal working condition, press down SET and ENTER, will enter system setting mode, before enter system setting mode, firstly, enter correct password PASS (generally, the deliver setting is 0001).

Method of enter password:

(1) press SET, then press ENTER again to enter pressing password condition;

(2) press left/right direction key, decrease/increase number up to correct password (Press down left/right direction key+ ENTER key at the same time can implement decrease/increase the hundreds'digit/tens'digit number);

(3) Press ENTER, to confirm data entered system setting mode.

■If pressing correct password, then entering system setting mode.



■ Meter's deliver default password setting is 0001.

■ Under system setting mode, at any time, click SET continuously, can exit system setting mode and inquire: save setting? (press ENTER to save, and press SET for Don't Save, press other key to continue setting) then return to measuring condition.

■ Under system setting mode, each item is stored in storage, after successful setting, before next setting, it is always valid.

### 5.3.2 系统设置模式下的操作

系统设置模式下，SET 键用来返回上级菜单，左右键用来切换设置的项目或者改变需要设置的内容，回车键用来确认需要设置的项目。系统设置模式下主要有以下设置项目：通讯地址及波特率设置(Addr, bAUd), 输入信号状况设置，变送输出设置(tr-1~tr-4)，密码(CodE)及清零(CLr.E)设置(SYS)下。

#### 5.3.2 Operation under system setting mode

Under system setting mode, SET key is used for return to previous menu, left key and right key is used for switching setting item or changing the content to be setting, ENTER is used for confirm the item to be setting. System setting mode have following primary setting items: Communication Address setting and Baud rate setting (Addr, bAUd), input signal condition setting, transmitting output setting (tr-1~tr-4), password (CodE) and zero clearing (CLr.E) setting (SYS).

### 5 3 3 变送输出设置

模拟变送输出可将电网中常见的 26 个电量(UA、UB、UC、UAB、UBC、UCA、IA、IB、IC、PA、PB、PC、P 总、QA、OB、QC、Q 总、PFA、PFB、PFC、PF、SA、SB、SC、S 总、F)中的其中最多四个量隔离变送输出为 4~20mA 的直流信号。

#### 5.3.3 Transmitting output setting

For common grid 26 electric parameters(UA、UB、UC、UAB、UBC、UCA、IA、IB、IC、PA、PB、PC、P total、QA、QB、QC、Q total、PFA、PFB、PFC、PF、SA、SB、SC、S total、F), the analog transmitting output can mostly isolate 4 items to transmit output DC signal of 4~20mA.

显示 Display				意义 Meaning
9	10	11	12	设置序号 Setting serial number
tr-1	tr-2	tr-3	tr-4	变送设置符号及序数 Transmit setting symbol and ordinal number
102	102	102	102	左起第一位为变送选择，如果是 4-20mA 输出，则为 1；第三、四位为变送量的选择，01 代表 UA，02 代表 UB.....26 代表频率（即将上面提到的 26 个电量按顺序 1~26 进行排序） The first left bit is transmitting selection, 4-20mA output=1; the third, the fourth bit is transmitting quantity selection, 01 represent UA, 02 represent UB.....26 represent frequency (Sort above 26 electric parameters as sequence 1~26)
5000	5000	5000	5000	20mA 对应显示值，取最高四位整数（小数点忽略）不足后面补 0。例如电流 600A/5A，则当 600A 对应 20mA 时，该值设为 6000；若要设置功率时，如 10kV/100V, 600A/5A，三相四线，则 100% 功率为 $10kV \times 600A \times \sqrt{3} = 1039.2kW$ ，则该值为 1039；若三相三线则为 $10kV \times 600A \times \sqrt{3} = 1039.2kW$ ，该值设为 1039 20mA corresponding to displayed value, take highest four-digit

		<p>integers (ignoring decimal point) with 0 occupy lacking bit. Example: current 600A/5A, when 600A corresponding to 20mA, setting=6000; For setting power, as 10k/100V, 600A/5A, four wire three phase, then</p> <p>100% power is <math>10kV \times 600A \times \sqrt{3} = 1039.2kW</math>, Value=1039; For</p> <p>three phase three wire then <math>10kV \times 600A \times \sqrt{3} = 1039.2kW</math>,</p> <p>Value=1039</p>
--	--	---

## 6 通讯指南 Communication guide

### 6.1 通讯

在本章主要讲述如何利用软件通过通讯口来操控该变送器。本章内容的掌握需要您具有 MODBUS 协议的知识储备并且通读了本册其它章节所有内容，对本产品功能和应用概念有较全面了解。

本章内容包括：MODBUS 协议简述，通讯应用格式详解，本机的应用细节及参量地址表。

#### 6.1 Communication

This chapter mainly describes how to use software through communication port to operate and control this transmitter. To grasp content in this chapter, you should have enough knowledge accumulation of MODBUS protocol, read and familiar with all content of this manual, and full understanding of functions and application concept of this product.

This section covers: MODBUS protocol compendium, expounding communication apply formatting, details for applying this machine and parameter address table.

#### 6.2 MODBUS 协议简述

BD-3E(A)/BD-4E(A)多电量组合变送器使用的是 MODBUS-RTU 通讯协议，MODBUS 协议详细定义了校验码、数据序列等，这些都是特定数据交换的必要内容。MODBUS 协议在一根通讯线上使用主从应答式连接（半双工），这意味着在一根单独的通讯线上信号沿着相反的两个方向传输。首先，主计算机的信号寻址到一台唯一的终端设备（从机），然后，终端设备发出的应答信号以相反的方向传输给主机。

MODBUS 协议只允许在主机（PC，PLC 等）和终端设备之间通讯，而不允许独立的终端设备之间的数据交换，这样各终端设备不会在它们初始化时占据通讯线路，而仅限于响应到达本机的查询信号。

#### 6.2 MODBUS protocol compendium

BD-3E(A)/BD-4E(A) multiple electric parameters combined transmitter use MODBUS-RTU communication protocol, MODBUS protocol define detailedly: check code, data sequence etc., these are necessary content for specific data exchange. MODBUS protocol use master/slave responding connection (half-duplex) on one communication line, this means on one separated communication line, signal transmit in opposite directions. Firstly, master computer signal addressed only one terminal device (slave), then, the reply signal sent by terminal device transmit to the master in opposite directions.

MODBUS protocol only allow communication between the master (PC, PLCetc.) and terminal device, but not allow data exchange between independent terminal devices, so, each terminal device does not occupy communication line in the initialization, only respond query signal reach to the computer.

#### 6.3 查询—回应周期

#### 6.3 Query-respond period

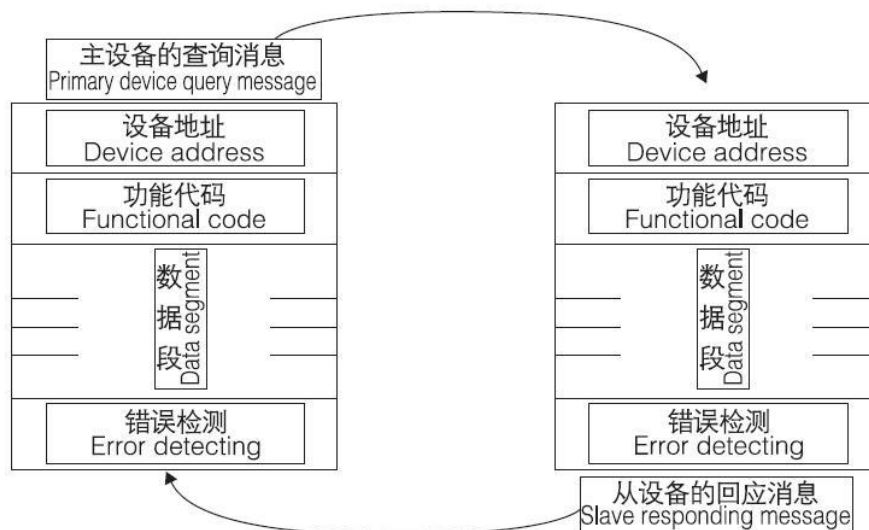

主-从 查询-回应周期表  
Master - slave query-respond period table

### 6.3.1 查询

查询消息中的功能代码告之被选中的从设备要执行何种功能。数据段包含了从设备要执行功能的任何附加信息。例如功能代码 03 是要求从设备读保持寄存器并返回它们的内容。数据段必须包含要告之从设备的信息：从何寄存器开始读及要读的寄存器数量。错误检测域为从设备提供了一种验证消息内容是否正确的方法。

#### 6.3.1 Query

The functional code of query message tells the selected slave device to implement what function. Data segment included any additional message implemented function by slave device. For example: functional code 03 demand slave device to read holding register and return their content. The data segment must include message to be telling to slave device: the register starting read and register quantity to be read. Error detecting domain provide slave device with one method to verify the message content is correct or not.

### 6.3.2 回应

如果从设备产生一正常的回应，在回应消息中的功能代码是在查询消息中的功能代码的回应。数据段包括了从设备收集的数据：如寄存器值或状态。如果有错误发生，功能代码将被修改以用于指出回应消息是错误的，同时数据段包含了描述此错误信息的代码。错误检测域允许主设备确认消息内容是否可用。

#### 6.3.2 Respond

If slave device produce one normal respond, the functional code of respond message is enquiring the respond of functional code of query message. The data segment include data collected by slave device: such as register value or condition. If error occur, functional code will be revised to indicate that the respond message is wrong, while the data segment include code describing this error message. Error detecting domain allow primary device to confirm message content is usable or not.

## 6.4 传输方式

传输方式是指一个数据帧内一系列独立的数据结构以及用于传输数据的有限规则，下面定义了与 MODBUS 协议- RTU 方式相兼容的传输方式。

每个字节的位

- 1 个起始位
- 18 个数据位，最小的有效位先发送
- 无奇偶校验位
- 1 个停止位

错误检测(Error checking)

CRC（循环冗余校验）

#### 6.4 Transmission mode

Transmission mode refer to one series of independent data structure, and limited regulation used for transmission data in one data frame, the transmission mode compatible with MODBUS protocol-RTU mode is defined as follows:

Bit of each byte:

- One start bit
- Eight data bit, least significance bit first transmitting
- Non-Parity bit
- 1 stop bit

Error detecting (Error checking)

CRC (cyclic redundancy check)

#### 6.5 协议

当数据帧到达终端设备时，它通过一个简单的“端口”进入被寻址到的设备，该设备去掉数据帧的“信封”（数据头），读取数据，如果没有错误，就执行数据所请求的任务，然后，它将自己生成的数据加入到取得的“信封”中，把数据帧返回给发送者。返回的响应数据中包含了以下内容：终端从机地址(Address)、被执行了的命令(Function)、执行命令生成的被请求数据(Data)和一个校验码(Check)。发生任何错误都不会有成功的响应，或者返回一个错误指示帧。

#### 6.5 Protocol

When Data frame reach terminal device, enter addressed device by a simple "port" this device remove Data frame "envelope" (data head), read data, if there is no error, executing task requested by data, then, add the new produced data in the obtained "envelope", return the data frame to the transmitter. Returned responding data include following content: slave terminal address (Address), executed command (Function), requested data produced by executing command (Data) and one CRC check code (Check). If any error occur, no successful responding or returning one error indication frame.

#### 6.5.1 数据帧格式

##### 6.5.1 Protocol

地址 Address	功能 Function	数据 Data	校验 Check
8-Bits	8-Bits	N×8-Bits	16-Bits

#### 6.5.2 地址域

地址域在帧的开始部分，由一个字节（8位二进制码）组成，十进制为0~255，在我们的系统中只使用1~247，其它地址保留。这些位标明了用户指定的终端设备的地址，该设备将接收来自与之相连的主机数据。每个终端设备的地址必须是唯一的，仅仅被寻址到的终端会响应包含了该地址的查询。当终端发送回一个响应，响应中的从机地址数据便告诉了主机哪台终端正与之进行通信。

#### 6.5.2 Address domain

Address domain is located at beginning of frame, composed of one byte (8 bit binary system domain), decimal system is 0~255, in the ACR meters, just 1~247 is used, other address is Reserved. these bits indicate terminal device address specified by users, this device will receive the connecting host computer data. Every terminal device has its only one address, only the addressing terminal is responding enquiry including this address. When terminal is Transmitting one responding, the responding slave address data tell host computer that which terminal is communicating with it.

#### 6.5.3 功能域

功能域代码告诉了被寻址到的终端执行何种功能。下表列出了该变送器用到的功能码，以及它们的意义

和功能。

### 6.5.3 Function domain

Function domain tell the addressed terminal to execute what function. Below table list: function domain used in this Series meters, and their meaning and function.

代码 Code	意义 Meaning	行为 Action
03	读数据寄存器 Read data register	获得一个或多个寄存器的当前二进制值 Obtain current binary value of one or multiple register
16	预置多寄存器 Preset multi-register	设定二进制值到一系列多寄存器中 Set binary value into a series of multiple register

### 6.5.4 数据域

数据域包含了终端执行特定功能所需要的数据或者终端响应查询时采集到的数据。这些数据的内容可能是数值、参考地址或者设置值。例如：功能域码告诉终端读取一个寄存器，数据域则需要指明从哪个寄存器开始及读取多少个数据，内嵌的地址和数据依照类型和从机之间的不同内容而有所不同。

### 6.5.4 Data domain

Data field is including the data needed by terminal for executing specific function, or the collected data when terminal is responding enquiry. Content of these data may be value, reference address or setting value. For example: The function domain tell terminal to Read one register, the data field need to specify the starting register and Read how many data, the built-in address and data have different content depending on type and slave computer.

### 6.5.5 错误校验域

该域允许主机和终端检查传输过程中的错误。有时，由于电噪声和其它干扰，一组数据在从一个设备传输到另一个设备时在线路上可能会发生一些改变，出错校验能够保证主机或者终端不去响应那些传输过程中发生了改变的数据，这就提高了系统的安全性和效率，错误校验使用了 16 位循环冗余的方法(CRC16)。

### 6.5.5 Error check field

This field allows the error in checking and transmitting of host computer and terminal. Due to electric noise and other interfere, when one group of data is transmitting from one device to another device, on the transmitting line, some change may be produced. The error check can enable the host computer or terminal not responding those changed data, so, safety, reliability and efficiency of system are upgraded. It used 16 bit Cyclic Redundancy Check (CRC16).

### 6.6 错误检测的方法

错误校验(CRC)域占用两个字节，包含了一个 16 位的二进制值。CRC 值由传输设备计算出来，然后附加到数据帧上，接收设备在接收数据时重新计算 CRC 值，然后与接收到的 CRC 域中的值进行比较，如果这两个值不相等，就发生了错误。

### 6.6 Method to create error check code (CRC)

Error check (CRC) domain occupy 2 byte, including one 16 bit binary system value. CRC value is calculated by transmission device, then attached to the data frame, the receiving device, while receiving, it calculates the CRC value again, then comparing it with the receiving CRC domain value, if these two values is not equal, it shows a error occurs.

CRC 运算时，首先将一个 16 位的寄存器预置为全 1，然后连续把数据帧中的每个字节中的 8 位与该寄存器的当前值进行运算，仅仅每个字节的 8 个数据位参与生成 CRC，起始位和终止位以及可能使用的奇偶位都不影响 CRC。在生成 CRC 时，每个字节的 8 位与寄存器中的内容进行异或，然后将结果向低位移位，高位则用“0”补充，最低位(LSB)移出并检测，如果是 1，该寄存器就与一个预设的固定值(0A001H)进行一次异或运算，如果最低位为 0，不作任何处理。

When operating, firstly, preset one 16-bit register as All-1, then continuously operating each byte 8 bit of Data frame and current value of this register, only every 8 data bit of each byte to participate in forming CRC the start bit

and stop bit and usable parity bit have no affect on the CRC. When forming CRC, every 8 data bit of each byte and content of register carry out exclusive or operation, then shift the result to the low bit the high bit is filled with 0, shift out the least significant bit (LSB) is shifted out and tested, if it is 1, this register and one preset fixed value (0A001H) carry out one exclusive or operation, if the least significant bit is 0, no treating is needed.

上述处理重复进行，直到执行完了 8 次移位操作，当最后一位（第 8 位）移完以后，下一个 8 位字节与寄存器的当前值进行异或运算，同样进行上述的另一个 8 次移位异或操作，当数据帧中的所有字节都作了处理，生成的最终值就是 CRC 值。

The above said processing is performed repeatedly, until finishing shift operation for 8 times, after the last bit (8th bit) is shifted, the next 8 bit byte and register current value carry out exclusive or operation, after all byte of data frame have been treated, the result final value is CRC value.

生成一个 CRC 的流程为：

- 1、预置一个 16 位寄存器为 0FFFFH（全 1），称之为 CRC 寄存器。
- 2、把数据帧中的第一个字节的 8 位与 CRC 寄存器中的低字节进行异或运算，结果存回 CRC 寄存器。
- 3、将 CRC 寄存器向右移一位，最高位填以 0，最低位移出并检测。
- 4、如果最低位为 0：重复第三步（下一次移位）；如果最低位为 1：将 CRC 寄存器与一个预设的固定值 (0A001H)进行异或运算。
- 5、重复第三步和第四步直到 8 次移位。这样处理完了一个完整的八位。
- 6、重复第 2 步到第 5 步来处理下一个八位，直到所有的字节处理结束。
- 7、最终 CRC 寄存器的值就是 CRC 的值。

此外还有一种利用预设的表格计算 CRC 的方法，它的主要特点是计算速度快，但是表格需要较大的存储空间，该方法此处不再赘述，请参阅相关资料。

Flow for forming one CRC:

1. Preset one 16 bit register as 0FFFFH (All-1), called as CRC register.
2. 8 bit of data frame first byte and low byte of CRC register carry out exclusive or operation, then save its result back to CRC register.
3. Right shift CRC register for one bit, the most significant bit is filled with 0, the least significant bit is shifted out and tested.
4. If the least significant bit is 0, Repeat the third step (next shift); If the least significant bit is 1, CRC register and preset fixed value specified (0A001H) carry out exclusive or operation.
5. Repeat the third step and the fourth step until shift for 8 times, the complete 8 bit is done.
6. Repeat the second step to the fifth step to treat next 8 bit until all the byte is treated.
7. The CRC register final value is CRC value.

Besides, there is another CRC calculation method by preset table, its main feature is fast calculating speed, but large saving space is needed, please refer to related data.

## 6.7 通讯应用格式详解

本节所举实例将尽可能的使用如图所示的格式，（数字为 16 进制）。

### 6.7 Communication apply format expound

Example used in this section possibly adopt format shown in below diagram, (digital as Hex).

从机地址 Addr	功能码 Fun	数据起始地址 寄存器高字节 Data start Reg hi	数据起始地址 寄存器低字节 Data start Reg lo	数据读取个数 寄存器高字节 Data # of Regs hi	数据读取个数 寄存器低字节 Data # of Regs lo	循环冗余校验 低字节 CRC16 lo	循环冗余校验 高字节 CRC16 hi
01H	03H	00H	00H	00H	03H	05H	CBH

#### 6.7.1 读数据（功能码 03）

### 查询数据帧

此功能允许用户获得设备采集与记录的数据及系统参数。 主机一次请求的数据个数没有限制，但不能超出定义的地址范围。

下面的例子是从 01 号从机读 3 个采集到的基本数据（数据帧中每个地址占用 2 个字节）UA、UB、UC，其中 UA 的地址为 0025H，UB 的地址为 0026H，UC 的地址为 0027H。

#### 6.7.1 Read data (function code03)

##### Query data frame

This function allows user to obtain data and system parameter collected and recorded by device. The data number every requested by host computer have no limit, but must not exceed the defined Address range.

Below example is three basic data collected from reading No.01 slave (each Address of data frame occupy 2 byte) UA、UB、UC, thereinto UA's Address is 0025H, UB's Address is 0026H, UC's Address is 0027H.

从机地址 Addr	功能码 Fun	数据起始地址 寄存器高字节 Data start Reg hi	数据起始地址 寄存器低字节 Data start Reg lo	数据读取个数 寄存器高字节 Data # of Regs hi	数据读取个数 寄存器低字节 Data # of Regs lo	循环冗余校验 低字节 CRC16 lo	循环冗余校验 高字节 CRC16 hi
01H	03H	00H	25H	00H	03H	14H	00H

### 响应数据帧

响应包含从机地址、功能码、数据的数量和 CRC 错误校验。

下面的例子是读取 UA、UB、UC(UA=082CH, UB=082AH, UC=082CH)的响应。

##### Respond data frame

Respond include: slave Address, function code, data number and CRC error check.

Below example is result of reading UA、UB、UC(UA=082CH, UB=082AH, UC=082CH) respond.

从机地址 Addr	功能码 Fun	字节 计数 Byte count	数据 1 高字节 Data1 hi	数据 1 低字节 Data1 lo	数据 2 高字节 Data2 hi	数据 2 低字节 Data2 lo	数据 3 高字节 Data3 hi	数据 3 低字节 Data3 lo	循环 冗余校验 低字节 CRC16 lo	循环 冗余校验 高字节 CRC16 hi
01H	03H	06H	08H	2CH	08H	2AH	08H	2CH	94H	4EH

### 错误指示码

如果主机请求的地址不存在则返回错误指示码：FFH。

##### Error indicating code

If the Address requested by host computer is inexistence, then return to Error indicating code: FFH.

#### 6.7.2 预置多寄存器（功能码 16）

##### 查询数据帧

功能码 16 允许用户改交多个寄存器的内容，该变送器中系统参数、电度量可用此功能号写入。主机一次最多可以写入 16 个(32 字节)数据。

下面的例子是预置 01 号从机吸收有功电度(正有功电度)EP\_imp 为 178077833wh.16 进制为 0A9D4089H。EP\_imp 的地址是 003FH、0040H，EP\_imp 占用 32 位，共 4 个字节。

#### 6.7.2 Preset multi- register (function code16)

##### Query data frame

Function code16 allow user to change content of multiple register, system parameter in this transmitter, write in electric energy quantity with this function number. For the host computer, the most data number once written in is 16 (32byte).

Below example is that preset No.01 slave absorptive active electric energy (Positive active electric energy)

EP\_imp as 178077833wh. Hex as 0A9D4089H. EP\_imp Address is 003FH, 0040H, EP\_imp occupy 32 byte, total of 4 bytes.

地址 Addr	功能码 Fun	起始数据 寄存器高字节 Data start reg hi	起始数据 寄存器低字节 Data start reg lo	数据读取个数 寄存器高字节 Data #of regs hi	数据读取个数 寄存器低字节 Data #of regs lo
01H	10H	00H	3FH	00H	02H

高字节数据 Value hi	低字节数据 Value lo	高字节数据 Value hi	低字节数据 Value lo	CRC 低字节 CRC lo	CRC 高字节 CRC hi
0AH	9DH	40H	89H	38H	91H

#### 响应数据帧

对于预置单寄存器请求的正常响应是在寄存器值改变以后回应机器地址、功能号、数据起始地址、数据个数、CRC 校验码。如图。

#### Respond dataframe

Normal Respond for request of preset single register is that after register value is changed, respond the machine Address, function number, Data start Address, data number, CRC check code. Shown as below diagram.

地址 Addr	功能码 Fun	起始数据 寄存器高字节 Data start reg hi	起始数据 寄存器低字节 Data start reg lo	字节数 Bytecount	CRC16 低字节 CRC16 lo	CRC16 高字节 CRC16 hi
01H	10H	00H	3FH	04H	0DH	33H

#### 错误指示码

如果主机请求的地址不存在或数据个数不正确则返回错误指示码：FFH。

#### Error indicating code

If the Address requested by host computer is inexistence, or data number is not correct, then return to Error indicating code: FFH.

#### 6.8 多电量组合变送器的应用细节及参量地址表

该变送器的测量值用 Modbus-RTU 通讯规约的 03 号命令读出。

通讯值与实际值之间的对应关系如下表：（约定 Val<sub>t</sub> 为通讯读出值，Val<sub>s</sub> 为实际值）

#### 6.8 Rpplication details and parameter Address table of combined multiple electric parameters transmitter

Measured value of this transmitter is read-out by 03 command of Modbus-RTU communication protocol.

The congruent relationship between communication value and actual value are shown as below diagram:(Agreed on Val<sub>t</sub> as communication read-out value, Val<sub>s</sub> as actual value)

适用参量 Applicable parameter	对应关系 Congruent relationship	单位 UnitVolt
电压值 UA、UB、UC Voltage value UA、UB、UC	$Val_s=(Val_t/10000)*(10^{DPT})$	伏(V) (V)
电流值 IA、IB、IC Current value IA、IB、IC	$Val_s=(Val_t/10000)*(10^{DCT})$	安培(A) Ampere(A)
功率值 PA、PB、PC、PS、QA、QB、QC、QS Power Value PA、PB、PC、PS、QA、QB、QC、QS	$Val_s=(Val_t/10000)*(10^{DPQ})$	瓦(w) Watt(w) 乏(var) var(var)



电度量一次侧值 EpI、EpE、EqL、EqC Electric energy quantity primary side value EpI、EpE、EqL、EqC	$Val_s=Val_t*PT*CT$	瓦时(wh) Watt-hour(wh) 乏时(varh) Var-hour(varh)
功率因数 PFA、PFB、PFC、PFS Power factor Value PFA、PFB、PFC、PFS	$Val_s=Val_t/1000$	无单位 No-unit
频率 FR Frequency FR	$Val_s=Val_t/100$	赫兹(Hz) Hertz(Hz)

范例：UA 的通讯读出值为 08C6H(2246)，DPT 为 5，则 UA 的实际值

$$Va=(2246/10000)*(10^5)=22.46KV。$$

IA 的通讯读出值为 0FA0H(4000)，DCT 为 3，则 IA 的实际值

$$Ia=(4000/10000)*(10^3)=400.0A$$

Example: UA's communication Read-out Value is 08C6H(2246), DPT is 5, then UA's actual Value

$$Va=(2246/10000)*(10^5)=22.46KV.$$

IA's communication Read-out Value is 0FA0H(4000), DCT is 3, then IA's actual Value

$$Ia=(4000/10000)*(10^3)=400.0A.$$

#### BD-3E(A)/BD-4E(A)多电量数字变送器参量地址表

#### BD-3E(A)/BD-4E(A) Multiple electric parameters combined transmitter parameter Address table

以下为系统参量地址区：03H 功能码读，10H 功能码写 Follows are system parameters Address area: 03H function code Reading, 10H function code writing				
地址 Address	参数 Parameter	读写属性 Read/Write	数值范围 Data range	数据类型 Data Type
0000H	保护密码 Protective password	R/W	0001~9999	word
0001H 高字节 0001H High byte	通讯地址 Communication Address	R/W	0001~0247	word
0001H 低字节 0001H Low byte	通讯波特率 Communication Baud rate	R/W	0~3 对应 38400、19200、9600、4800bps 0~3 corresponding to 38400、19200、9600、4800bps	
0002H	控制字 Control word	R/W	第 8 位-接线方式(0-三相四线，1-三相三线)；第 7 位-输入电压范围(0-400V，1-100V)；第 2 位-输入电流范围(0-5A，1-1A) 8 <sup>th</sup> bit-connection mode(0-four wire three phase, 1-three phase three wire); 7 <sup>th</sup> bit-input voltage range(0-400V, 1-100V); second bit-input current range(0-5A, 1-1A)	word
0003H	PT 变比 PT Transformation ratio	R/W	1~9999	word
0004H	CT 变比 CT Transformation ratio	R/W	1~9999	word
0005H-0022H	保留			

	Reserved			
0023H 高字节 0023H high byte	小数点 U(DPT) Decimal point U(DPT)	R		word
0023H 低字节 0023H low byte	小数点 I(DCT) Decimal point I(DCT)	R		
0024H 高字节 0024H high byte	小数点 PQ(DPQ) Decimal point PQ(DPQ)	R		word
0024H 低字节 0024H low byte	符号 PQ Symbol PQ	R		
0025H	相电压 UA Phase voltage UA	R	0~65535	word
0026H	相电压 UB Phase voltage UB	R	0~65535	word
0027H	相电压 UC Phase voltage UC	R	0~65535	word
0028H	线电压 UAB Line voltage UAB	R	0~65535	word
0029H	线电压 UBC Line voltage UBC	R	0~65535	word
002AH	线电压 UAC Line voltage UAC	R	0~65535	word
002BH	电流 IA Current IA	R	0~65535	word
002CH	电流 IB Current IB	R	0~65535	word
002DH	电流 IC Current IC	R	0~65535	word
002EH	分相有功功率 PA Phase splitting active power PA	R	-32768~32768	Integer
002FH	分相有功功率 PB Phase splitting active power PB	R	-32768~32768	Integer
0030H	分相有功功率 PC Phase splitting active power PC	R	-32768~32768	Integer
0031H	总有功功率 P Total active power P	R	-32768~32768	Integer
0032H	分相无功功率 QA Phase splitting reactive power QA	R	-32768~32768	Integer
0033H	分相无功功率 QB Phase splitting reactive power QB	R	-32768~32768	Integer
0034H	分相无功功率 QC Phase splitting reactive power QC	R	-32768~32768	Integer
0035H	总无功功率 Q Total reactive power Q	R	-32768~32768	Integer
0036H	分相功率因数 PFA Phase splitting power factor PFA	R	-1000~1000	Integer
0037H	分相功率因数 PFB Phase splitting power factor PFB	R	-1000~1000	Integer

0038H	分相功率因数 PFC Phase splitting power factor PFC	R	-1000~1000	Integer
0039H	总功率因数 PF Total power factor PF	R	-1000~1000	Integer
003AH	分相视在功率 SA Phase splitting Apparent power SA	R	0~65535	Word
003BH	分相视在功率 SB Phase splitting Apparent power SB	R	0~65535	Word
003CH	分相视在功率 SC Phase splitting Apparent power SC	R	0~65535	Word
003DH	总视在功率 S Total Apparent power S	R	0~65535	Word
003EH	频率 FR Frequency FR	R	4500~6000	Word
003FH-0040H	吸收有功电度 EP_imp 二次侧 Absorptive active electric energy EP_imp secondary side	R/W	0~999999999	Dword
0041H-0042H	释放有功电度 EP_exp 二次侧 Release active electric energy EP_exp secondary side	R/W	0~999999999	Dword
0043H-0044H	感性无功电度 EQ_imp 二次侧 Inductive reactive electric energy EQ_imp secondary side	R/W	0~999999999	Dword
0045H-0046H	容性无功电度 EQ_exp 二次侧 Capacitive reactive electric energy EQ_exp secondary side	R/W	0~999999999	Dword
0047H-0048H	吸收有功电度 EpI 一次侧 Absorptive active electric energy EpI primary side	R		Fword
0049H-004AH	释放有功电度 EpE 一次侧 Release active electric energy EpE primary side	R		Fword
004BH-004CH	感性无功电度 EpL 一次侧 Inductive reactive electric energy EpL primary side	R		Fword
004DH-004EH	容性无功电度 EpC 一次侧 Capacitive reactive electric energy EpC primary side	R		Fword

几点说明:

1 数据类型:“BYTE”指 1 个字节;“word”指 16 位无符号整数;“Integer”指 16 位有符号整数;“Dword”指 32 位无符号整数,“Fword”指 32 位浮点数。

2 读写属性:“R”只读,读参量用 03H 号命令;“R/W”可读可写,写系统参量用 10H 号命令。禁止向未列出的或不具可写属性的地址写入。

3 波特率的设定范围 4800bps, 9600bps, 19200 bps, 38400 bps。在此范围外的设定是不允许的。如果写入超范围的设定值,变流器会启用默认波特率:38400 bps。

4 电度一次侧时的值采用浮点变量数据类型。它用符号位表示数的符号,用阶码和尾数表示数的大小。

变送器采用的数据格式为 IEEE754 数据格式具有 24 位精度，尾数的高位始终为“1”，因而不保存，位的分布如下

- a) 1 位符号位；
- b) 8 位指数位；
- c) 23 位尾数。

符号位是最高位，尾数为最低的 23 位，按字节描述如下：

Instructions:

1 Data type: "BYTEV"=one byte; "word"=16 bit unsigned integer; "Integer"=16 bit signed integer; "Dword"=32 bit unsigned integer; "Fword"=32 bit floating point numbers.

2 Read/Write Properties: "R"=Read only, Read parameter use 03H Command; "R/W"= Readable/Writable, Write system parameter use 10H Command. Prohibit write in Address, which is not listed or without writable properties.

3 Baud rate setting range: 4800 bps, 9600 bps, 19200 bps, 38400 bps. Settings outside this range are not allowable. If setting go beyond this range is write-in, transmitter can enable the default Baud rate: 38400 bps.

4 Electric energy primary side value adopt floating point variable data type. It use sign bit to show number sign, use biased exponent and mantissa to show larger and smaller numbers. Data format adopted by transmitter is IEEE754, with 24 bit precision, high bit of mantissa is always"1", thus, Don't Save, bit distribution is shown as following:

- a) 1 bit as sign bit;
- b) 8 bit exponents bit;
- c) 23 bit mantissa.

Sign bit is the highest bit, mantissa is the lowest 23 bit, the description based on byte is shown as follows:

地址 Address	+0	+1	+2	+3
内容 Content	SEEE EEEE	EMMM MMMM	MMMM MMMM	MMMM MMMM

其中，S: 符号位，1 表示负，0 表示正；

E: 阶码（在两个字节中）偏移为 127；

M: 23 位尾数，最高位为“1”。

Thereinto, S: Sign bit, 1 shows negative, 0 shows positive;

E: biased exponent (in two bytes) biased 127;

M: 23 bit mantissa, its highest bit is "1".

具体举例如下：

读出 0 10001110 100 1011 1010 1100 0000 0000B

0 代表符号位，“1”为负，“0”为正；

10001110 为计算指数，设为 a，a 为 10 进制，a 为 142；

100 1011 1010 1100 0000 0000 为计算尾数，设为 b，b 为 10 进制，b 为 4959232。

For example:

Read-out 0 10001110 100 1011 1010 1100 0000 0000B

0 shows sign bit, "1"negative, "0"positive;

10001110=gage index, set it to a, a is decimal system, a=142;

100 1011 1010 1100 0000 0000 is computing mantissa, set it to b, b is decimal system, b=4959232.

计算公式：

Computing formula:

$$\begin{array}{l} \text{一次侧电量} \\ \text{Primary side} \\ \text{electric parameters} \end{array} = (-1)^S \times 2^{(E-127)} \times \left(1 + \frac{M}{2^{23}}\right)$$

上例计算结果为:

Computed result:

$$= (-1)^0 \times 2^{(142-127)} \times \left(1 + \frac{4959232}{2^{23}}\right) = 52140$$

## 7 订货实例 Order example

### 7.1 BD-AI 接线实例

#### 7.1 BD-AI Connection example

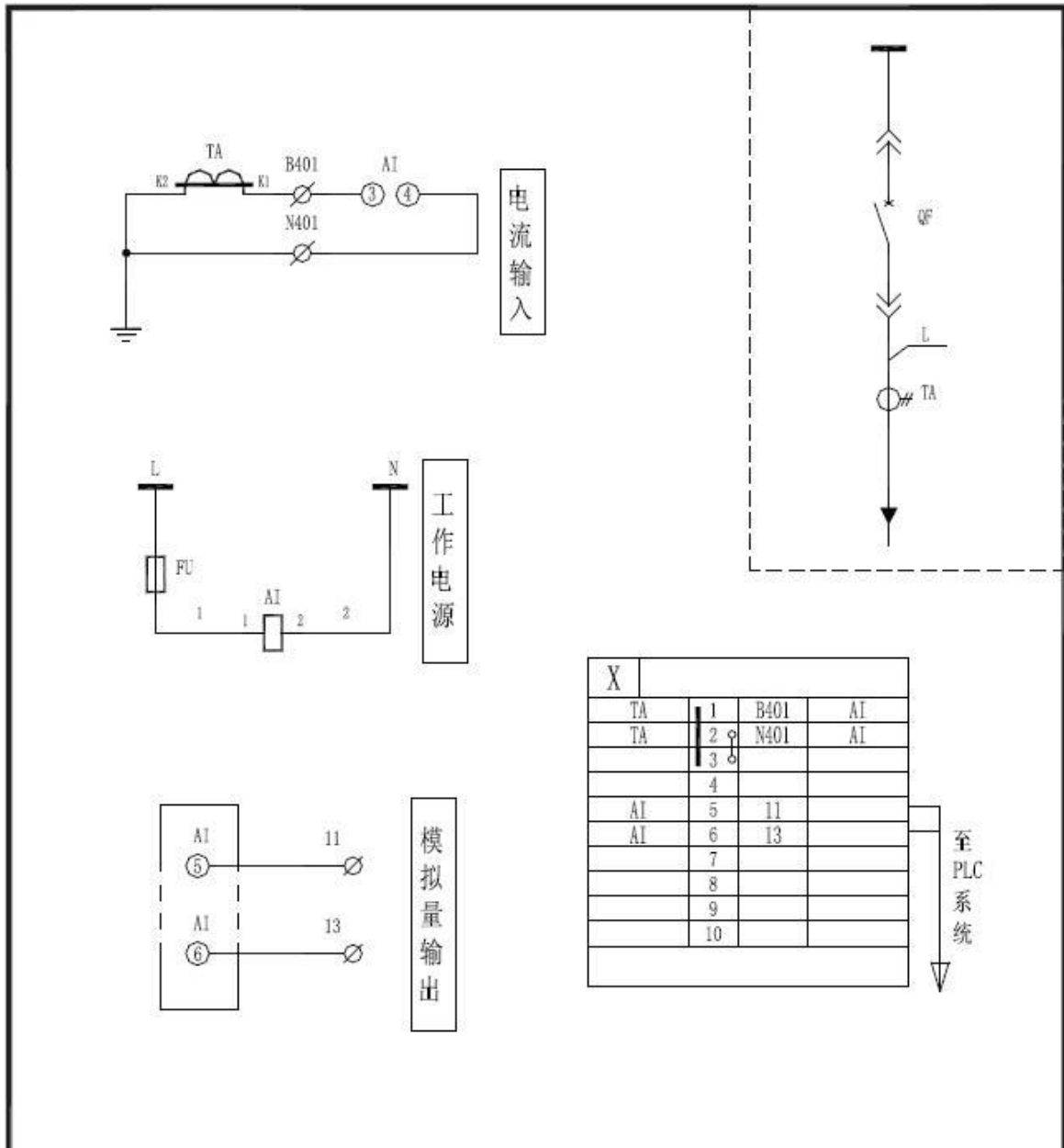

4	FU	熔断器	RT14-20/2A	1	
3	AI	单相电流变送器	BD-AI In:5A Out:4-20mA	1	AC220V
2	TA	电流互感器	AKH-0.66	1	
1	QF	断路器		1	
序号	标号	名称	型号规格	数量	备注
合同号		柜号			
			BD-AI 单相电流变送器		
标记	处数	更改文件号	签名	日期	
设计		标准化			
制图		审定			
校核		批准			
工艺		日期			
			接线实例		
			图样标记		重量 比例
			共 1 张		第 1 张
上海安科瑞电气有限公司					

7.2 BD-3I3 接线实例

7.2 BD-3I3 Connection example

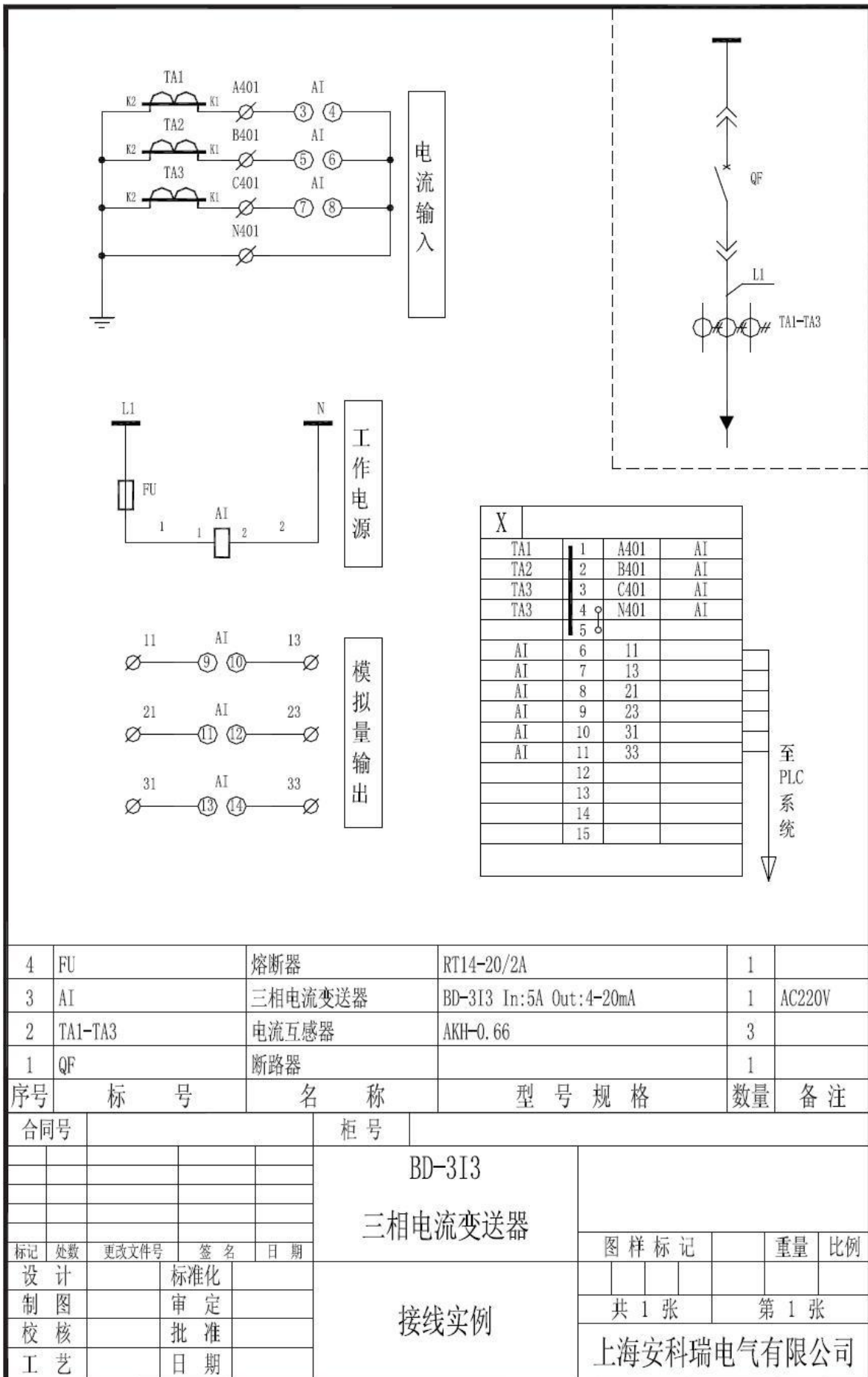

7.3 BD-3V3 接线实例

7.3 BD-3V3 Connection example

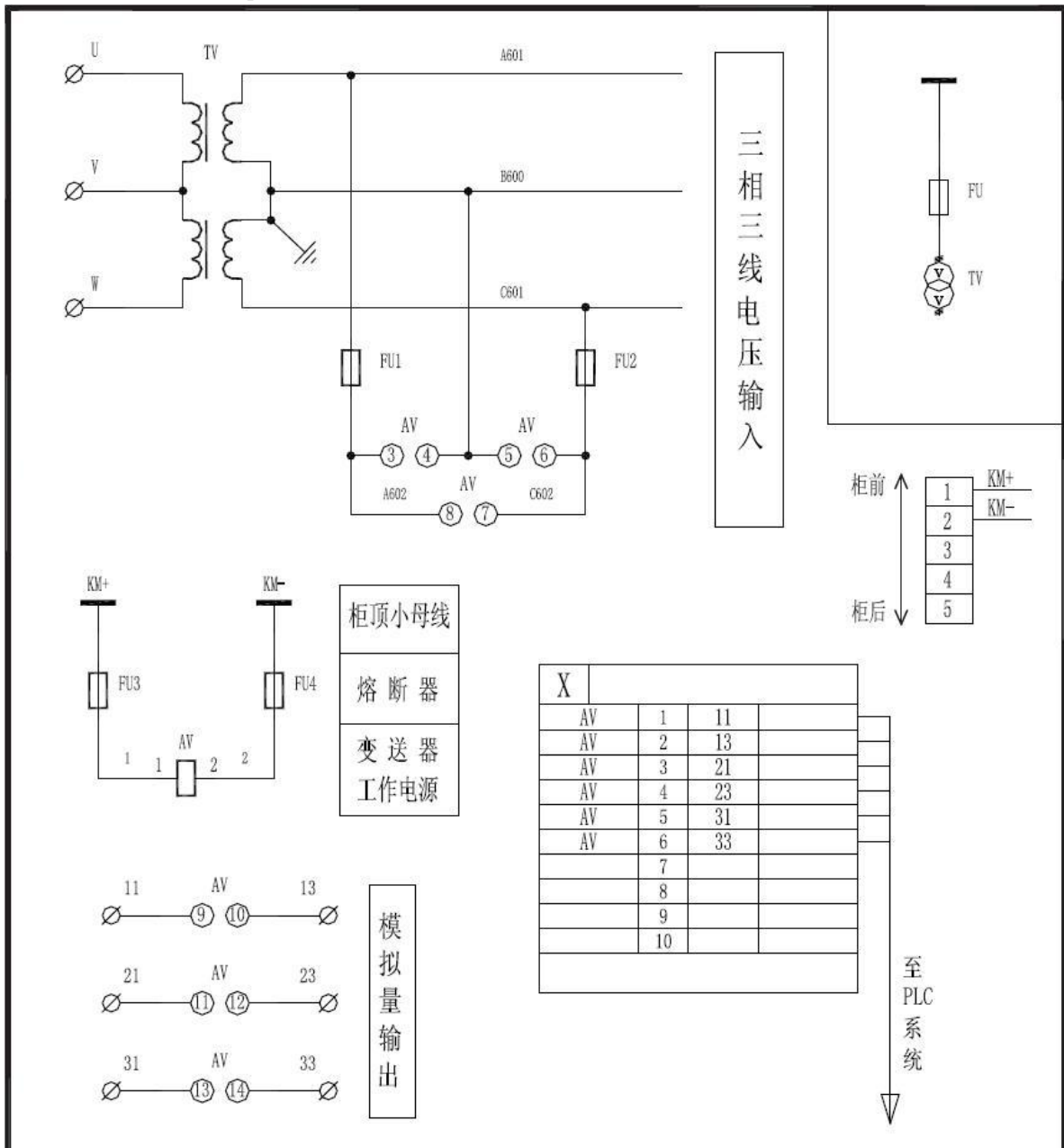

4	FU1-FU4	熔断器	RT14-20/2A	4	
3	FU	熔断器		3	
2	AV	三相三线电压变送器	BD-3V3 In:100V Out:4-20mA	1	
1	TV	电压互感器		2	
序号	标号	名称	型号规格	数量	备注
合同号		柜号			
			BD-3V3		
			三相三线电压变送器		
标记	处数	更改文件号	签名	日期	
设计			标准化		
制图			审定		
校核			批准		
工艺			日期		
			接线实例		
		图样标记		重量	比例
		共 1 张		第 1 张	
上海安科瑞电气有限公司					



7.4 BD-PF 接线实例

7.4 BD-PF Connection example

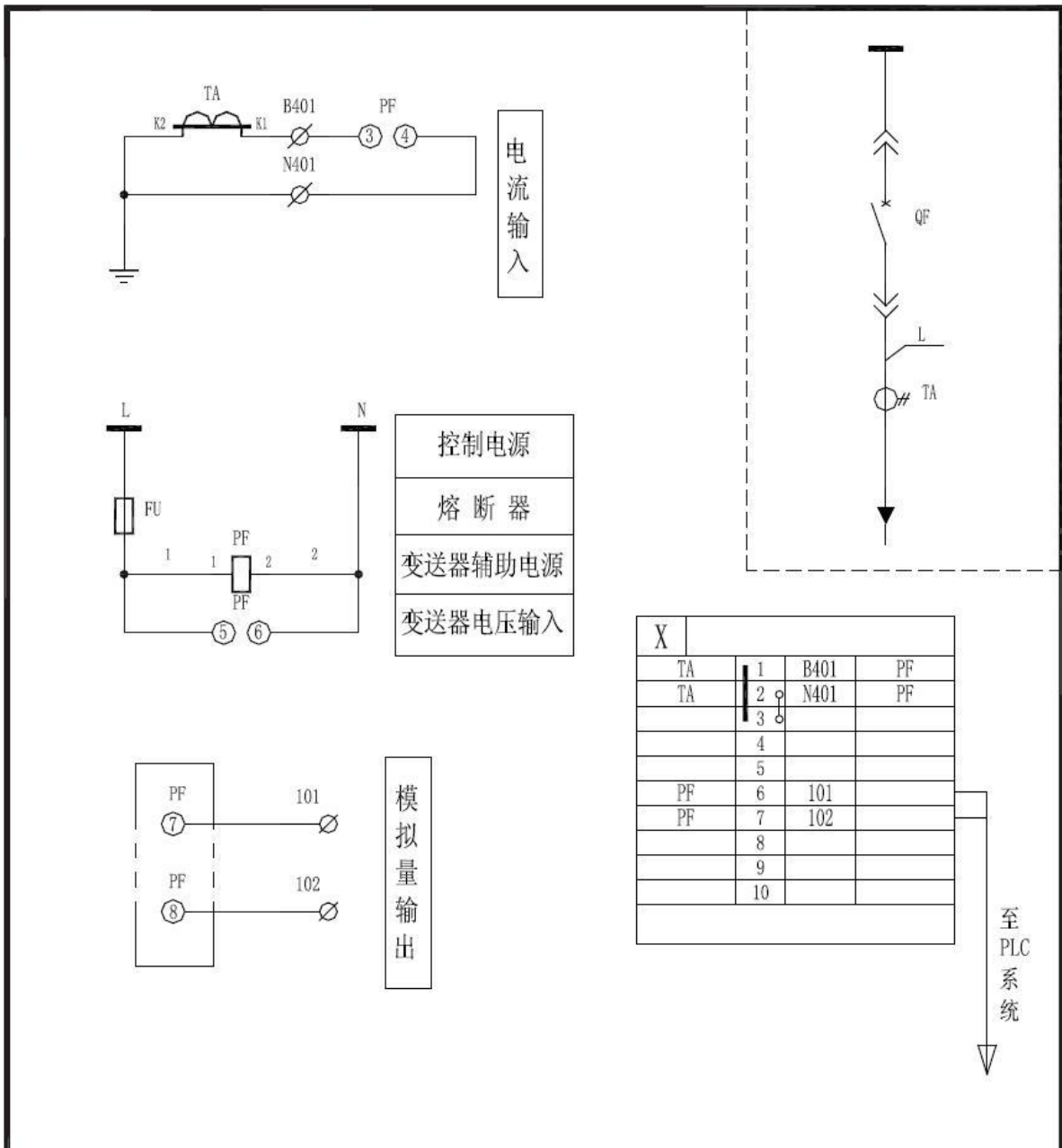

4	FU	熔断器	RT14-20/2A	1	
3	PF	单相功率因数变送器	BD-PF In:220V 5A Out:4-20mA	1	AC220V
2	TA	电流互感器	AKH-0.66	1	
1	QF	断路器		1	
序号	标号	名称	型号规格	数量	备注
合同号		柜号			
		BD-PF			
		单相功率因数变送器			
标记	处数	更改文件号	签名	日期	图样标记
设计		标准化			重量
制图		审定			比例
校核		批准			
工艺		日期			
接线实例				共 1 张	
				第 1 张	
上海安科瑞电气有限公司					

7.5 BD-4P 接线实例

7.5 BD-4P Connection example

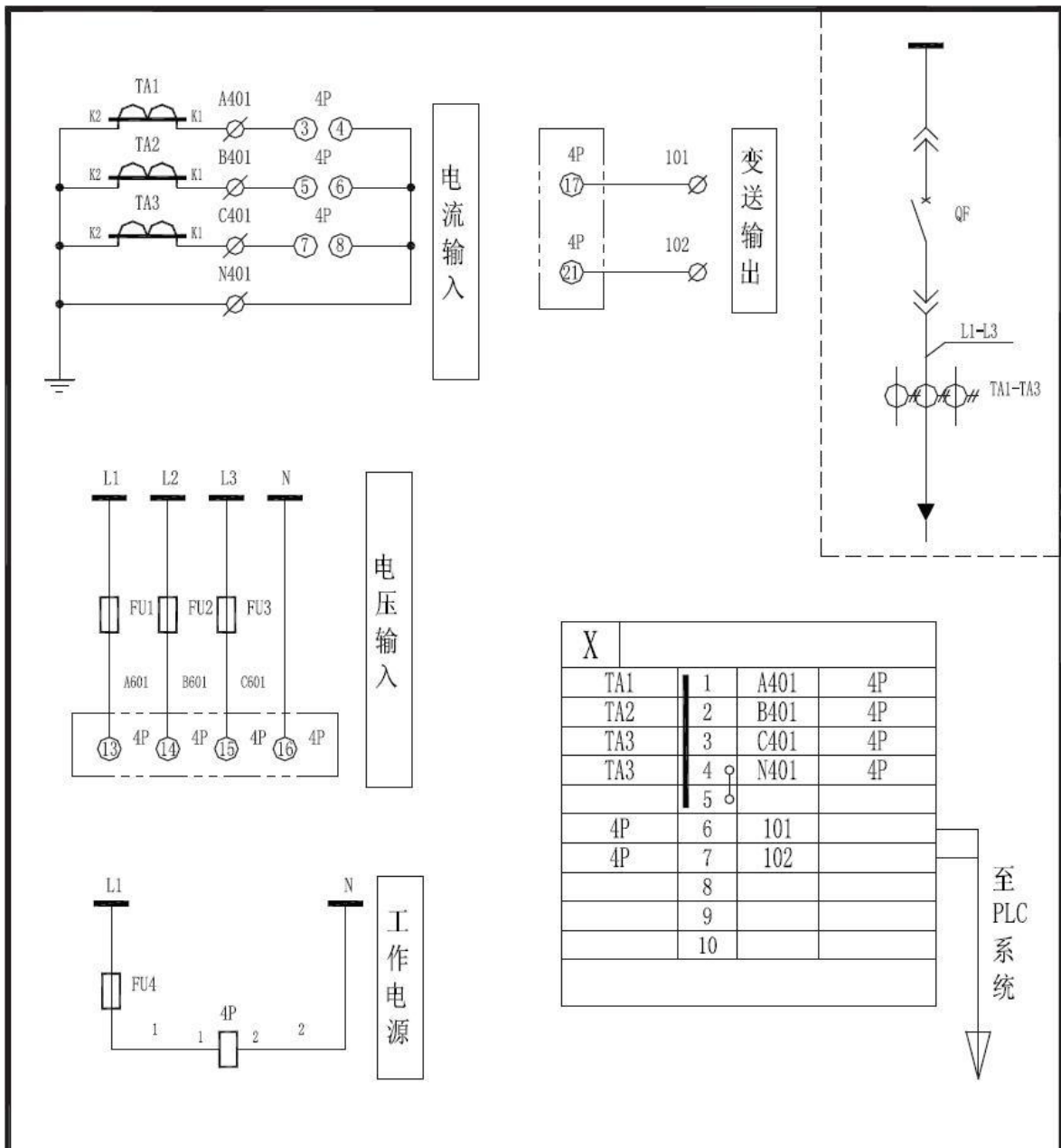

4	FU1-FU4	熔断器	RT14-20/2A	4	
3	4P	有功功率变送器	BD-4P In:220V, 5A Out:4-20mA	1	AC220V
2	TA1-TA3	电流互感器	AKH-0.66	3	
1	QF	断路器		1	
序号	标号	名称	型号规格	数量	备注
合同号		柜号			
			BD-4P		
			三相四线有功功率变送器		
标记	处数	更改文件号	签名	日期	图样标记
设计			标准化		重量
制图			审定		比例
校核			批准		
工艺			日期		
接线实例				共 1 张	
				第 1 张	
上海安科瑞电气有限公司					

7.6 BD-4E 接线实例

7.6 BD-4E Connection example

工作电源

电压输入

电流输入

脉冲量输出

通讯接口

模拟变送输出

X	1	A401	AE
	2	B401	AE
	3	C401	AE
	4	N401	AE
	5		
	6	11+	
	7	11-	
	8	13+	
	9	13-	
	10		
	11	101	
	12	102	
	13	103	
	14	104	
	15	COM	
	16		
	17	A	
	18	B	
	19	COM	
	20		

至 PLC 系统

至 脉冲接收器

4	FU1-FU4	熔断器	RT14-20/2A	4
3	AE	多电量数字变送器	BD-4E In:220V, 5A Out:4-20mA	1 AC220V
2	TA1-TA3	电流互感器	AMH-0.66	3
1	QP	断路器		1

型号规格 数量 备注

柜号

BD-4E

三相四线多电量数字变送器

接线实例

图样标记	重量
共 1 张	第 1 张

上海安科瑞电气有限公司

7.7 通讯接线实例 Connected mode in communication

关于通讯部分的接线实例如下图所示：

Four Connection mode in communication section are shown as following:

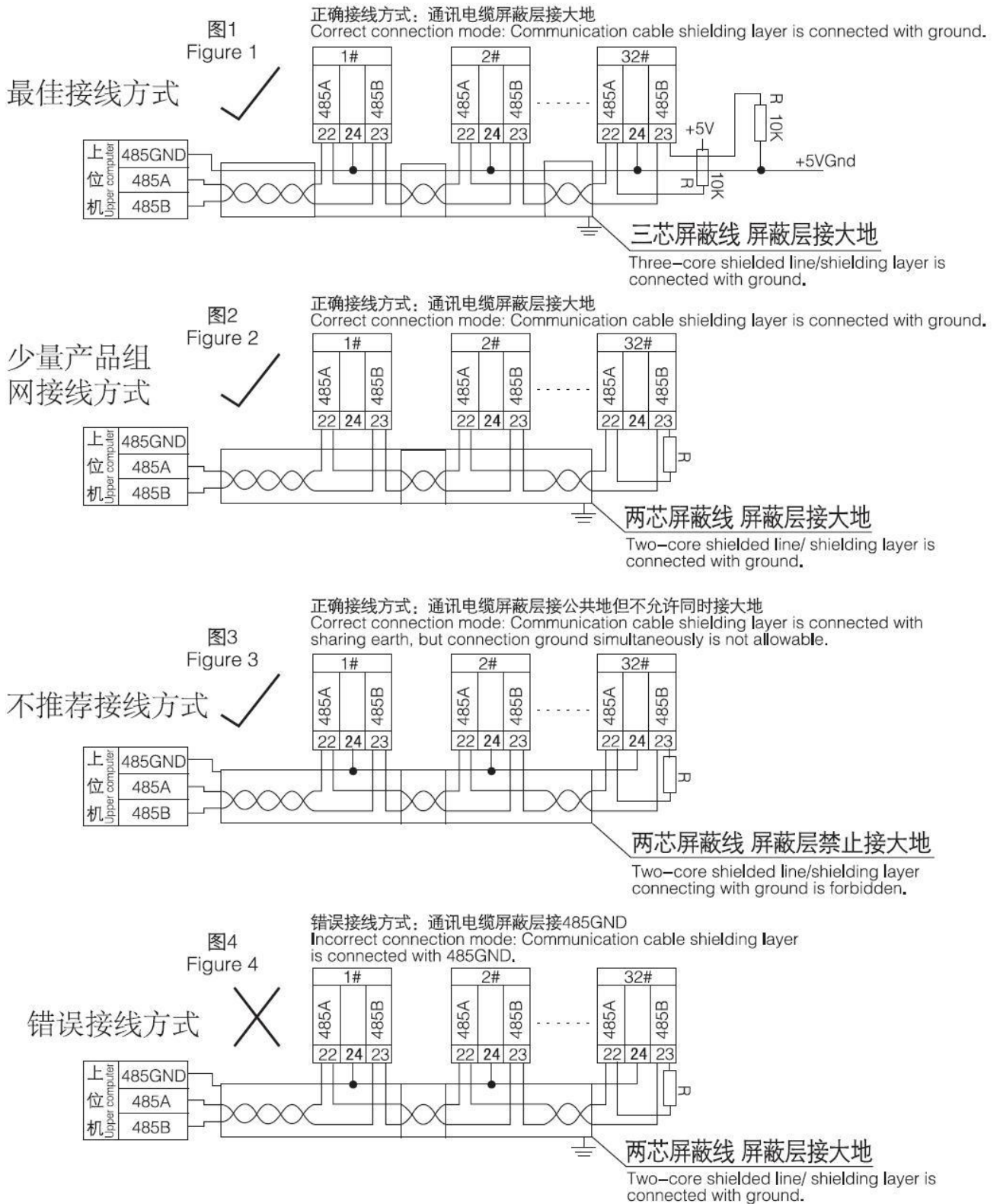

建议最末端仪表的 A、B 之间加匹配电阻，阻值范围为 120Ω~10kΩ。

Recommendation of adding matched resistance between A, B of the last meter, the rated resistance range is 120Ω~10kΩ.

总部：安科瑞电气股份有限公司

Headquarter: Acrel Co., Ltd.

地址：上海市嘉定马东工业园区育绿路 253 号

Add: No.253 Yulv Road, Madong Industrial Park, jiading District, Shanghai, China

Tel: (86) 21-69158300 69158301 69158302

Fax: (86) 21-69158303 69158339

服务热线 Service Hot Line: 800-820-6632

Http://www.acrel.cn E-mail: ACREL001@vip.163.com

PC: 201801

生产基地：江苏安科瑞电器制造有限公司

Production Base: Jiangsu Acrel Appliance Manufacture Co., Ltd.

地址：江阴市南闸镇东盟工业园区东盟路 5 号

Add: 5 Domeng Road Dongmeng Industrial Park Nanzha town Jiangyin

Tel: (86) 0510-86179966 86179967 86179968

Fax: (86) 0510-86179975 86179970

E-mail: JY-ACREL001@vip.163.com

PC: 214405

## 更改记录:

- 1、条款 4.2、4.5、4.8 的仪表用新外壳取代旧外壳
- 2、规范辅助电源、电压输入和电流输入接线图，以及规范 RS485 通讯接线图；条款 4.2、4.5、4.7 仪表增加通讯接线图
- 3、条款 7.7 的通讯接线实例图更改，图中删去 COM2