

426

Sales manager : Tim Ma
Tel/whatsapp/wechat : 86 18761599716
E-mail : tim.ma@email.acrel.cn
Website: www.acrel.gr



ARTU Series of Remote Terminal Units

Installation and Operation Manual V1.0

Acrel Co., Ltd.

Declaration

All rights reserved. Without written permission of the Company, no paragraph or chapter in this Manual shall be extracted, copied, or reproduced or disseminated in any form; otherwise, all consequences shall be borne by the offender.

The Company reserves all legal rights.

The Company reserves the right to modify the product specifications described in the Manual without prior notice.

Before ordering, please consult your local agent for the latest specifications of the product.

Contents

1. General.....	1
2. Model description.....	1
3. Technical Parameters.....	2
4. Installation and Wiring.....	3
4.1 Outline dimensions.....	3
4.2 Installation methods.....	3
4.3 Wiring.....	4
4.5 Application examples.....	6
5 Communication Description.....	7
5.1 Full parameter information of instrument.....	7
5.2 Instrument event record information.....	11
5.3 Read DI state.....	12
5.4 Read DO state.....	13
5.5 Communication examples.....	13
5.6 Detailed explanation of analog input and output signals.....	13
6. Appendixes.....	15
6.1 Dial switch settings.....	15
6.2 Modbus function code description.....	15
7 Communication Connection Modes.....	17
8 Debugging and Maintenance.....	17
8.1 Operation instructions.....	17
8.2 Debugging.....	18

1. General

The ARTU series of remote terminal units are high performance intelligent distribution components, which are applied in intelligent distribution, industrial automation and other fields, the ARTU100 series of remote terminal units can provide switch input, switch output, analog input and analog output, and can transmit the collected signals to the background through RS485 serial ports, RJ45 Ethernet interfaces, and 2G, Lora and 4G wireless communication.

Conforming standards:

GB/T 19582.1-2004	Modbus industrial automation network specification. Part 1: Modbus application protocol
GB/T 19582.2-2008	Modbus industrial automation network specification. Part 2: Modbus protocol implementation guide over serial link
GB/T13729-2002	Remote terminal unit equipment
DL/T630—1997	Technical requirement for RTU with AC electrical quantities input discrete sampling
DL/T 634.5101-2009	Tele-control equipment and systems. Part 5-101: Transmission protocols
DL/T 634.5104-2009	Tele-control equipment and systems. Part 5-104: Transmission protocols

2. Model description

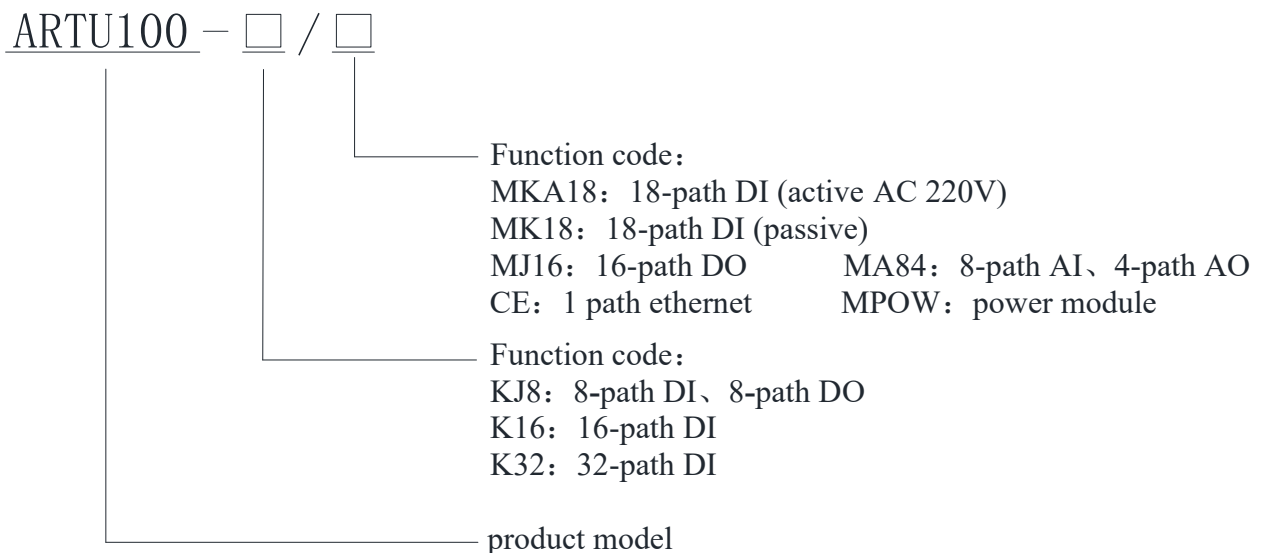

Note: MPOW power module must be selected when module is selected.

3. Technical Parameters

Subject:

Power supply	AC/DC 85-265V、 DC48V		
Power consumption	≤9W (excluding modules); ≤15W (including modules, up to 3 modules)		
Model	ARTU100-K32	32-path DI (active/passive, optional)	
	ARTU100-K16	16-path DI (active/passive, optional)	
	ARTU100-KJ8	8-path DI (active/passive, optional); 8-path DO, output mode: relay normally-open contact output, contact capacity: AC 250V/3A DC 30V/3A;	
Communication	485 communication	RS485 interface	2-path 485 communication; Modbus-RTU protocol; baud-rate 1200 ~ 38400bps
Others	Dial switch	10 bits	
	Indicator light	20 indicator lights	

Optional features:

Model	CE	1 path ethernet	TCP/IP protocol; 10M/100M self-adaptive	
	MKA18+MPOW	Switch input	18-path DI (active AC 220V)	
	MK18+MPOW	Switch input	18-path DI (passive)	
	MJ16+MPOW	Switch output	16-path DO output mode: Relay normally-open contact output	
	MA84+MPOW	Analog input	8-path AI; 0-5V, 1-5V, 4-20mA, 0-20mA, optional	
		Analog output	4-path AO; 0-5V, 1-5V, 4-20mA, 0-20mA, optional	
	AWT100-2G	2G communication terminal		
	AWT100-Lora	Lora communication terminal		
	AWT100-LW	LoRAWAN communication terminal		
	AWT100-NB	NB-IoT communication terminal		
AWT100-4G	4G communication terminal			

Other technical parameters:

Security	Working withstand voltage	Power-frequency withstand voltage: Shell and power supply, switch input, switch output, analog input, analog output, communication, AC 2kV 1min; AC 2kV 1min between power supply and switch output; AC 1kV 1min between analog input and analog output and between communication and switch input;
	Insulation resistance	Input and output end to housing > 100MΩ;
Electromagnetic compatibility	Superior to level 3	
Environment	Working temperature: -20℃~+60℃; Storage temperature: -40℃~+70℃; Relative humidity : ≤95% without condensation; Altitude: ≤2500m;	

4. Installation and Wiring

4.1 Outline dimensions

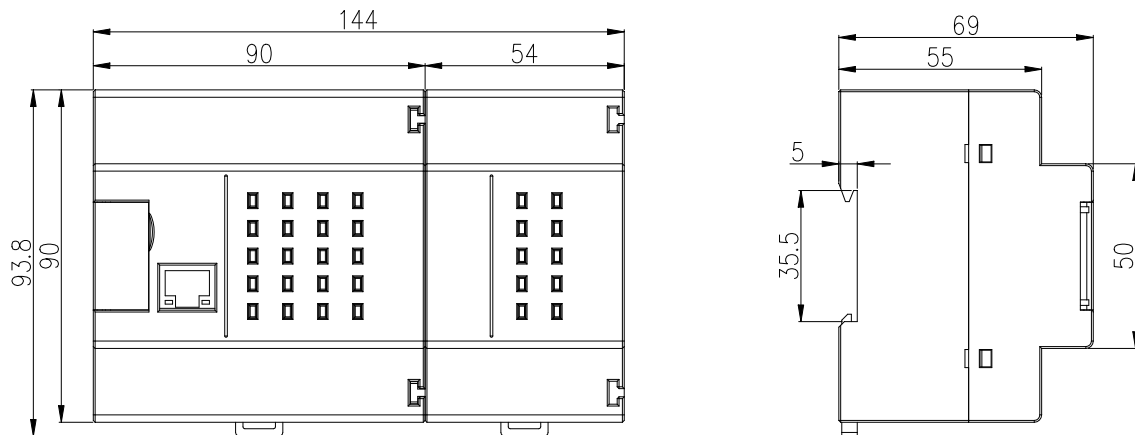

4.2 Installation methods

Guide rail and wall-hanging double installation methods are used.

4.3 Wiring

Subject:

ARTU100-K32:

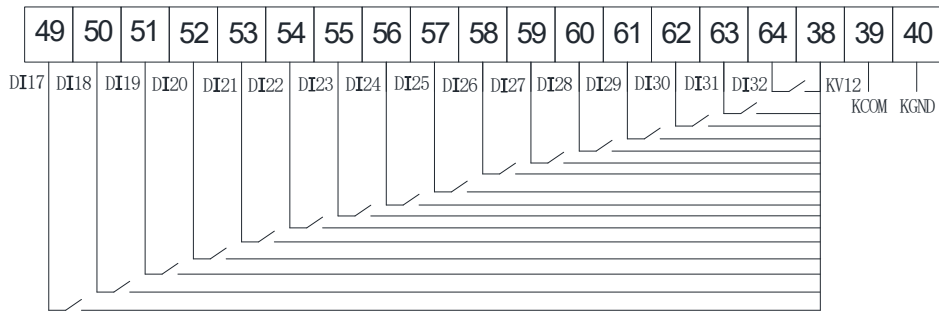
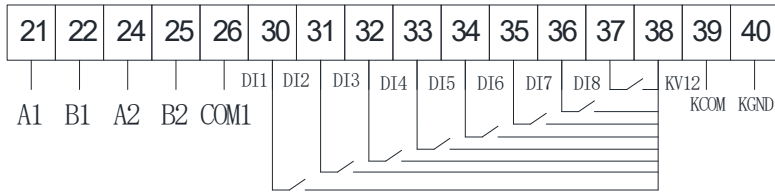
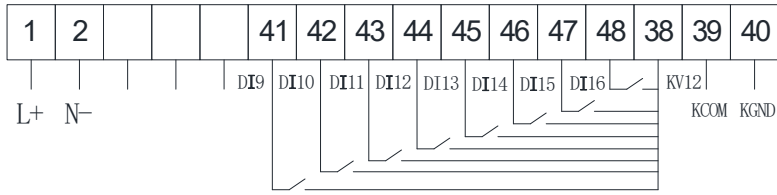

ARTU100-K16:

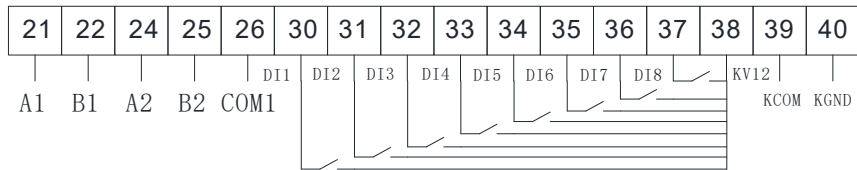
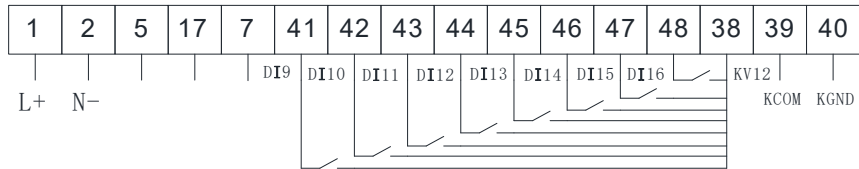

ARTU100-KJ8:

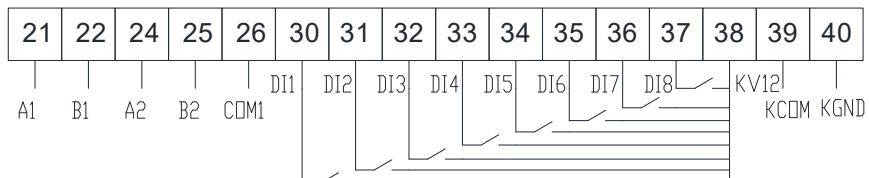
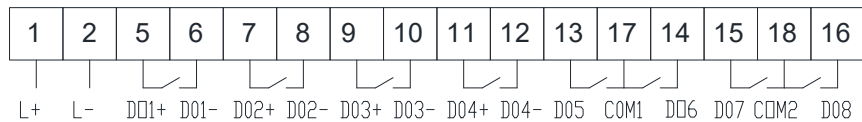

Modules:

MK18:

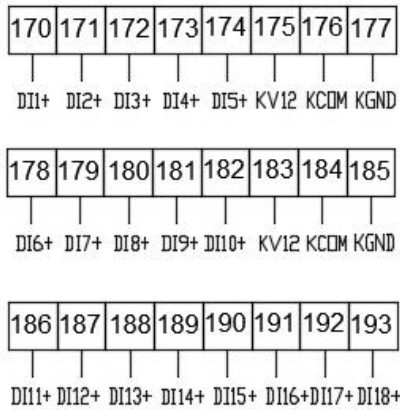

MKA18:

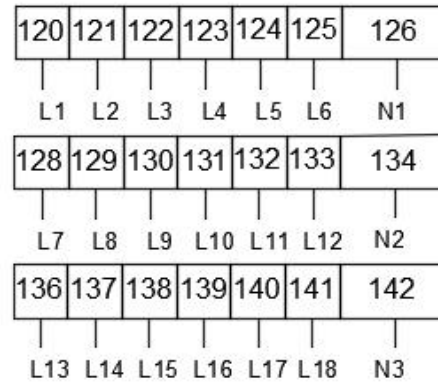

MJ16:

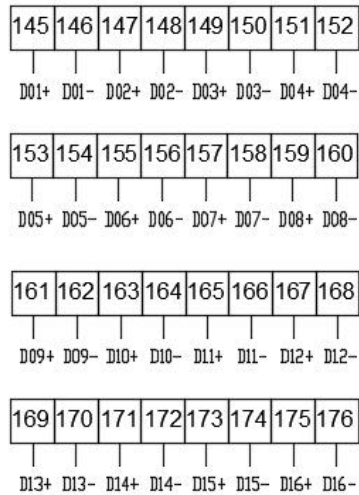

MA84:

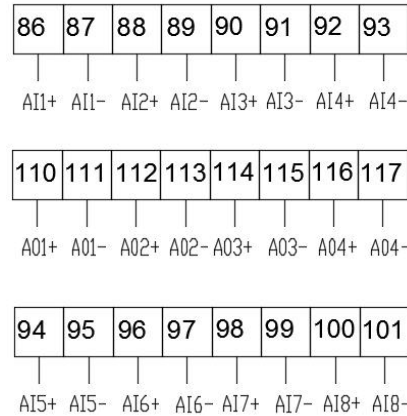

4.4 Indicator light status description

Subject:

Specifications	K16/K32/K8	KJ8
Indicator light description	<p>1. POW refers to the power light. 2. COM refers to the communication light. 3. EXT refers to the module communication light. 4. The number refers to the channel number (for example, K16 refers to DI1-DI16), the odd number refers to the red light, and the even number refers to the green light. (See the table below for specific information of indicator lights.)</p>	

Modules:

Specifications	MKA18/MK18	MJ16	MA84	MPOW
Indicator light description	<p>1. POW refers to the power light. 2. The number refers to the channel number, the odd number refers to the red light, and the even number refers to the green light. (See the table below for specific information of indicator lights.)</p>			

	Not lit	Lit			
		Green		Red	
		Normally on	Flashing	Normally on	Flashing
POW	No power	/	Normal power	/	/
COM	No communication	/	COM1, normal communication	/	COM2, normal communication
EXT	No connected modular	/	Connected modular and normal communication	/	Normal communication but failed communication
DI, DO, AI, AO status light	No status	Normal working	/	Normal working	/

4.5 Application examples

a) Wiring diagram of passive dry contacts:

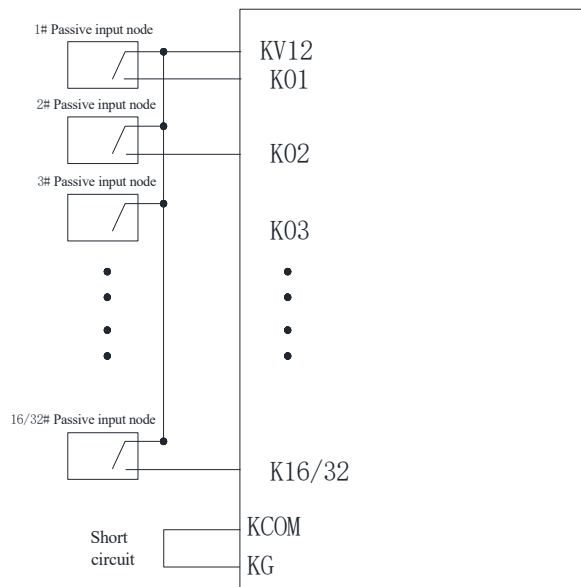

b) Wiring diagram of active wet contacts:

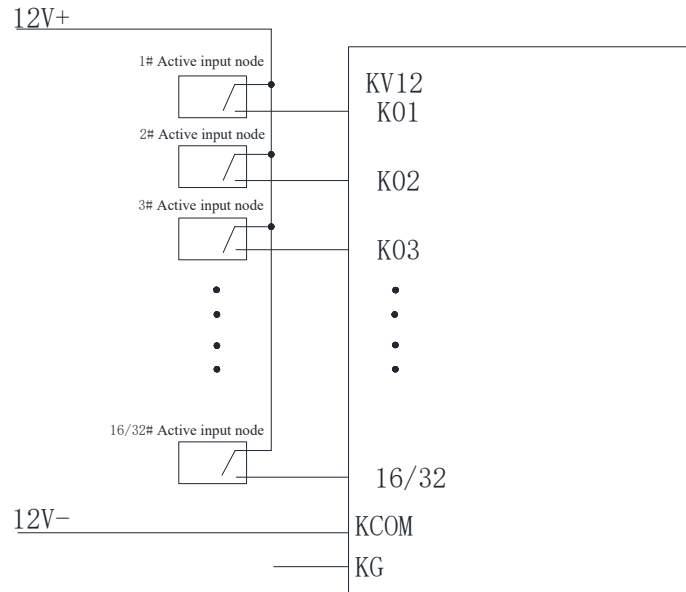

5 Communication Description

5.1 Full parameter information of instrument

Modbus function code 03(03H)、04(04H) can be used to access all contents in the address table ,and function code 16(10H) can be used to write continuous register data.

Address	Name	Data type	Read/write	Length	Remarks
0x1000	Addr1	Uint16	R/W	2	1-247 universal address: 250
0x1001	Baud1	Uint16	R/W	2	0: 1200 1: 2400 2: 4800 3: 9600 4: 19200 5: 38400
0x1002	Check1	Uint16	R/W	2	0: no check; 1: odd check; 2: even check
0x1003	Stop1	Uint16	R/W	2	0: 1 stop bit; 1: 2 stop bit
0x1004	Baud2	Uint16	R/W	2	0: 1200 1: 2400 2: 4800 3: 9600 4: 19200 5: 38400
0x1005	Check2	Uint16	R/W	2	0: no check; 1: odd check; 2: even check
0x1006	Stop2	Uint16	R/W	2	0: 1 stop bit; 1: 2 stop bit
0x1007	Baud3	Uint16	R/W	2	0: 1200 1: 2400 2: 4800 3: 9600 4: 19200 5: 38400
0x1008	Check3	Uint16	R/W	2	0: no check; 1: odd check; 2: even check
0x1009	Stop3	Uint16	R/W	2	0: 1 stop bit; 1: 2 stop bit
0x102C	SysTime-year/month	Uint16	R/W	2	high: year Low: month
0x102D	SysTime-day/hour	Uint16	R/W	2	high: day Low:time
0x102E	SysTime-minutes/second	Uint16	R/W	2	high: minutes Low: second

0x1450-0x1451	IP Address	Uint16	R/W	4	0x1450: high 192 low 168 0x1451: high 0 low 100
0x1452-0x1453	Subnet Mask	Uint16	R/W	4	0x1452: high 255 low 255 0x1453: high 255 low 0
0x1454-0x1455	Gateway Address	Uint16	R/W	4	0x1454: high 192 low 168 0x1455: high 0 low 0
0x1456	Port Number 1	Uint16	R/W	2	Default 5000
0x1457	Port Number 2	Uint16	R/W	2	Default 5001
0x1458	Port Number 3	Uint16	R/W	2	Default 5002
0x1459	Port Number 4	Uint16	R/W	2	Default 5003
0x2000	Main style	Uint16	R	2	High bit 1:ARTU100 2:ARTU100/CE Low bit 1:K32 2:K16 4:K8J8
0x2001	Main Version	Uint16	R	2	Such as: 100 is V1.00
0x2002	Main Software	Uint16	R	2	
0x2003	Model1 style	Uint16	R	2	1:MKA18 2: MJ16 3: MA84 4:MK18
0x2004	Model1 Version	Uint16	R	2	Such as: 100 is V1.00
0x2005	Model1 Software	Uint16	R	2	
0x2006	Model2 style	Uint16	R	2	1:MKA18 2: MJ16 3: MA84 4:MK18
0x2007	Model2 Version	Uint16	R	2	Such as: 100 is V1.00
0x2008	Model2 Software	Uint16	R	2	
0x2009	Model3 style	Uint16	R	2	1:MKA18 2: MJ16 3: MA84 4:MK18
0x200A	Model3 Version	Uint16	R	2	Such as: 100 is V1.00
0x200B	Model3 Software	Uint16	R	2	
0x2100	Clean SOE Record	Uint16	W	2	Write in 0xA8B8 clear event record
0xDE00	SOE Record Num	Uint16	R	2	1-100
0xFF21-0xFF23	Order Num	Uint16	R	2	0x FF21:1 2 3 4 0x FF22:5 6 7 8 0x FF23: 9 10 11 12
DO parameters setting					
0x5000	DO16-1 Statue	Uint16	R/W	2	0: opening 1: closing
0x5001	DO32-17 Statue	Uint16	R/W	2	0: opening 1: closing
0x5002	DO48-33 Statue	Uint16	R/W	2	0: opening 1: closing
0x5003	DO56-49 Statue	Uint16	R/W	2	0: opening 1: closing
0x5008	DO16-1 Start Statue	Uint16	R/W	2	0: opening 1: closing
0x5009	DO32-17 Start Statue	Uint16	R/W	2	0: opening 1: closing

0x500A	DO48-33 Start Statue	Uint16	R/W	2	0: opening 1: closing
0x500B	DO56-49 Start Statue	Uint16	R/W	2	0: opening 1: closing
0x5300	DO1 Time	Uint16	R/W	2	unit: second
0x5301	DO2 Time	Uint16	R/W	2	unit: second
0x5302	DO3 Time	Uint16	R/W	2	unit: second
0x5303-0x5337	DO4 Time – DO56 Time	Uint16	R/W	2	unit: second
DI parameters setting					
0x5010	DI16-1 Statue	Uint16	R	2	0: opening 1: closing
0x5011	DI32-17 Statue	Uint16	R	2	0: opening 1: closing
0x5012	DI48-33 Statue	Uint16	R	2	0: opening 1: closing
0x5013	DI64-49 Statue	Uint16	R	2	0: opening 1: closing
0x5014	DI80-65 Statue	Uint16	R	2	0: opening 1: closing
0x5015	DI86-81 Statue	Uint16	R	2	0: opening 1: closing
0x5018	DI16-1 Start Statue	Uint16	R	2	0: opening 1: closing
0x5019	DI32-17 Start Statue	Uint16	R	2	0: opening 1: closing
0x501A	DI48-33 Start Statue	Uint16	R	2	0: opening 1: closing
0x501B	DI64-49 Start Statue	Uint16	R	2	0: opening 1: closing
0x501C	DI80-65 Start Statue	Uint16	R	2	0: opening 1: closing
0x501D	DI86-81 Start Statue	Uint16	R	2	0: opening 1: closing
0x5100	DI1 Time	Uint16	R/W	2	unit: MS
0x5101	DI2 Time	Uint16	R/W	2	unit: MS
0x5102	DI3Time	Uint16	R/W	2	unit: MS
0x5103-0x5155	DI4 Time- DI86 Time	Uint16	R/W	2	unit: MS
0x5200	DI1 P-Time	Uint16	R/W	2	unit: MS
0x5201	DI2 P-Time	Uint16	R/W	2	unit: MS
0x5202	DI3 P-Time	Uint16	R/W	2	unit: MS
0x5203-0x5255	DI 4P-Time-DI86P-Time	Uint16	R/W	2	unit: MS
0x5600	DI1 Pulse	Uint16	R	2	unit: order
0x5601	DI2 Pulse	Uint16	R	2	unit: order
0x5602	DI3 Pulse	Uint16	R	2	unit: order
0x5603-0x5655	DI4 Pulse- DI86 Pulse	Uint16	R	2	unit: order Up to 86 DI Pulses
0x56A0	DI Pulse initial value	Uint16	R	2	Up to 86 DI Pulses
AI parameters setting					
0x5080	AI1 Statue	Int16	R	2	See 5.6 detailed explanation of analog input and output signals

0x5081	AI2 Statue	Int16	R	2	
0x5082	AI3 Statue	Int16	R	2	
0x5083-0x5097	AI4 Statue- AI24 Statue	Int16	R	2	
0x50C0	AI1 Statue	Uint16	R	2	The actual signal is the data divided by 10. for example, the actual signal of the voltage of 5000 pairs is 5V. the actual current signal corresponding to 20000 is 20mA.
0x50C1	AI2 Statue	Uint16	R	2	
0x50C2	AI3 Statue	Uint16	R	2	
0x50C3-0x50D7	AI4 Statue- AI24 Statue	Uint16	R	2	
00x5500	AI1 Style	Uint16	R/W	2	1: 0-20mA 2: 4-20mA 3: 0-5V 4: 1-5V
0x5501	AI 1High	Int16	R/W	2	The actual signal is the data divided by 10. for example, the actual signal of the voltage of 5000 pairs is 5V. the actual current signal corresponding to 20000 is 20mA.
0x5502	AI1 Low	Int16	R/W	2	The actual signal is the data divided by 10. for example, the actual signal of the voltage of 5000 pairs is 5V. the actual current signal corresponding to 20000 is 20mA.
0x5503	AI2 Style	Uint16	R/W	2	1: 0-20mA 2: 4-20mA 3: 0-5V 4: 1-5V
0x5504	AI2 High	Int16	R/W	2	
0x5505	AI2 Low	Int16	R/W	2	
0x5506	AI3 Style	Uint16	R/W	2	1: 0-20mA 2: 4-20mA 3: 0-5V 4: 1-5V
0x5507	AI3 High	Int16	R/W	2	
0x5508	AI3 Low	Int16	R/W	2	
0x5509-0x5547	AI4 Style、AI4 High、AI4 Low - AI24 Style、AI24 High、AI24 Low	Uint16 Int16 Int16	R/W	2	1: 0-20mA 2: 4-20mA 3: 0-5V 4: 1-5V
0x50A8	AI Shielding Value	Uint16	R/W	2	5 is 5‰
AO parameters setting					
0x50B0	AO1 Statue	Int16	R/W	2	The actual signal is the data divided by 10. for example, the actual signal of the voltage of 5000 pairs is 5V. the actual current signal corresponding to 20000 is 20mA.
0x50B1	AO2 Statue	Int16	R/W	2	

0x50B2	AO3 Statue	Int16	R/W	2	
0x50B3-0x50BB	AO4 Statue- AO12 Statue	Int16	R/W	2	
0x5400	AO1 Output type	Uint16	R/W	2	Output type: 1: 0-20mA 2: 4-20mA 3: 0-5V 4: 1-5V
0x5401	AO1 High	Int16	R/W	2	The actual signal is the data divided by 10. for example, the actual signal of the voltage of 5000 pairs is 5V. the actual current signal corresponding to 20000 is 20mA.
0x5402	AO1 Low	Int16	R/W	2	The actual signal is the data divided by 10. for example, the actual signal of the voltage of 5000 pairs is 5V. the actual current signal corresponding to 20000 is 20mA.
0x5403	AO2 Output type	Uint16	R/W	2	Output type: 1: 0-20mA 2: 4-20mA 3: 0-5V 4: 1-5V
0x5404	AO2 High	Int16	R/W	2	
0x5405	AO2 Low	Int16	R/W	2	
0x5406	AO3 Output type	Uint16	R/W	2	Output type: 1: 0-20mA 2: 4-20mA 3: 0-5V 4: 1-5V
0x5407	AO3 High	Int16	R/W	2	
0x5408	AO3 Low	Int16	R/W	2	
0x5400-0x5423	AO4 Output type、AO4 High、 AO4 Low - AO12 Output type、AO12 High、AO12 Low	Uint16 Int16 Int16	R/W	2	Input type: 1: 0-20mA 2: 4-20mA 3: 0-5V 4: 1-5V

5.2 Instrument event record information

The are 100 SOE from 0xD000 to 0xD960.It is recommended to read SOE Record Num first,and then calculate the corresponding address of the target event record according to the index number of the event record.

Address	Name	Content	Type	Read/write	Length	Remarks
0xD000	Event record number	Current event record number	Uint16	R	2	
0xD001	Action date	High byte: year Low byte: month	Uint16	R	2	
0xD002	Action time	High byte: day Low byte: time	Uint16	R	2	
0xD003	Action minutes and seconds	High byte: minutes Low byte: seconds	Uint16	R	2	
0xD004	Action MS	MS 0-999ms	Uint16	R	2	
0xD005	Action channel	DI 16-1	Uint16	R	2	
0xD006	Action channel	DI 32-17 is an incident	Uint16	R	2	

0xD007	Action channel	DI 48-33 is an incident	Uint16	R	2	
0xD008	Action channel	DI 64-49 is an incident	Uint16	R	2	
0xD009	Action channel	DI 80-65 is an incident	Uint16	R	2	
0xD00A	Action channel	DI 86-81 is an incident	Uint16	R	2	
0xD00B	Action channel	DO 16-1 is an incident	Uint16	R	2	
0xD00C	Action channel	DO 32-17 is an incident	Uint16	R	2	
0xD00D	Action channel	DO 48-33 is an incident	Uint16	R	2	
0xD00E	Action channel	DI 56-49 event status	Uint16	R	2	
0xD00F	Action state	DI 16-1 event status	Uint16	R	2	
0xD010	Action state	DI 32-17 event status	Uint16	R	2	
0xD011	Action state	DI 48-33 event status	Uint16	R	2	
0xD012	Action state	DI 64-49 event status	Uint16	R	2	
0xD013	Action state	DO 80-65 event status	Uint16	R	2	
0xD014	Action state	DO 86-81 event status	Uint16	R	2	
0xD015	Action state	DO 16-1 event status	Uint16	R	2	
0xD016	Action state	DO 32-17 event status	Uint16	R	2	
0xD017	Action state	DO 48-33 event status	Uint16	R	2	
0xD018	Action state	DO 56-49 event status	Uint16	R	2	
0xD019-0xD9C3		Items 2 to 100 event records	Uint16	R	2	

Note: each event record takes 23 addresses from the event record number to CRC, and the last address of each event record is the check bit(meaningless).

5.3 Read DI state

Read the DI status of ARTU tele signalling unit with modbus 02(02H) command

Address	Content	Type	Read/write	Remarks
0x0000	DI1 state	BIT	R	0: opening 1: closing
0x0001	DI2 state	BIT	R	0: opening 1: closing
0x0002	DI3 state	BIT	R	0: opening 1: closing
0x0003	DI4 state	BIT	R	0: opening 1: closing
0x0004	DI5 state	BIT	R	0: opening 1: closing
0x0005	DI6 state	BIT	R	0: opening 1: closing
0x0006	DI7 state	BIT	R	0: opening 1: closing
0x0007	DI8 state	BIT	R	0: opening 1: closing
0x0008	DI9 state	BIT	R	0: opening 1: closing
0x0009	DI10 state	BIT	R	0: opening 1: closing
0x000A	DI11 state	BIT	R	0: opening 1: closing

0x000B	DI12 state	BIT	R	0: opening 1: closing
0x000C	DI13 state	BIT	R	0: opening 1: closing
0x000D	DI14 state	BIT	R	0: opening 1: closing
0x000E	DI15 state	BIT	R	0: opening 1: closing
0x000F	DI16 state	BIT	R	0: opening 1: closing
0x0010-0x0055	DI17—DI86 state	BIT	R	0: opening 1: closing

5.4 Read DO state

Modbus function code 01(01H) can be used to access all contents in the address table ,and function code 05(05H) can be used to write register data.

Address	Content	Read/write	Remarks
0x0000	DO1 state	R/W	0: opening 1: closing
0x0001	DO2 state	R/W	0: opening 1: closing
0x0002	DO3 state	R/W	0: opening 1: closing
0x0003	DO4 state	R/W	0: opening 1: closing
0x0004	DO5 state	R/W	0: opening 1: closing
0x0005	DO6 state	R/W	0: opening 1: closing
0x0006	DO7 state	R/W	0: opening 1: closing
0x0007	DO8 state	R/W	0: opening 1: closing
0x0008	DO9 state	R/W	0: opening 1: closing
0x0009	DO10 state	R/W	0: opening 1: closing
0x000A	DO11 state	R/W	0: opening 1: closing
0x000B	DO12 state	R/W	0: opening 1: closing
0x000C	DO13 state	R/W	0: opening 1: closing
0x000D	DO14 state	R/W	0: opening 1: closing
0x000E	DO15 state	R/W	0: opening 1: closing
0x000F	DO16 state	R/W	0: opening 1: closing
0x0010-0x0037	DO17—DO56 state	R/W	0: opening 1: closing

5.5 Communication examples

Example 1: Read the current switch status of the remote communication unit with instrument address 2.

Send: 0x02,0x03,0x50,0x10,0x00,0x02,0XD4,0xFD

Return: 0x02,0x03,0x04,0x00,0x00,0x00,0x03,0x89,0x32

Note: The first and second channel switches of the remote communication unit with instrument address 2 are connected, and the remaining 30 channel switches are disconnected.

Example 2: Read the status of 1 to 5 switches

Send: 0x01,0x02,0x00,0x00,0x00,0x05,0xB8,0x09

Return: 0x01,0x02,0x01,0x10,0xA0,0x44

Note: 0x 10 is converted to a binary number of 0001,000, that is, the fifth switch is in the connected status, and the rest are in the disconnected status.

Example 3: Read the status of 1 to 32 switches.

Send: 0x01,0x02,0x00,0x00,0x00,0x20,0x79,0xD2

Return: 0x01,0x02,0x04,0x00,0x00,0x8E,0x04,0x9F,0x81

Note: 0x00,0x00,0x8E,0x04 are converted to binary numbers of 0000,0000,0000,0000,1000,1110,0000,0100, that is, the switches of paths 18, 19, 20, 24 and 27 are in the connected status, and the rest are in the disconnected status.

Example 4: Read the status of 17 to 32 switches.

Send: 0x01,0x02,0x00,0x10,0x00,0x10,0x78,0x03

Return: 0x01,0x02,0x02,0x8E,0x04,0xDD,0xDB

Note: 0x8E,0x04 are converted to binary numbers of 1000,1110,0000,0100, that is, the switches of paths 18, 19, 20, 24 and 27 are in the connected status, and the rest are in the disconnected status.

Example 5: Set the current time.

Send: 0x01,0x10,0x10,0x2C,0x00,0x03,0x06,0x15,0x02,0x18,0x11,0x06,0x1E, 0xDD,0x1D

Return: 0x01,0x10,0x10,0x2C,0x00,0x03,0x45,0x01

Note: It indicates that the time is set to 17:06:30 on February 24, 2021 (note the BCD code format).

Example 6: Set the buffeting elimination time of the remote communication unit with instrument address 1.

Send: 0x01,0x10,0x51,0x00,0x00,0x01,0x02,0x00,0x04,0Xe7,0x56

Return: 0x01,0x10,0x51,0x00,0x00,0x01,0x11,0x35

Note: The buffeting elimination time is set to 4ms (buffeting elimination time: in the vibration environment, the stroke switch or button often sends out the wrong signal due to buffeting, and the buffeting time is generally short. According to the characteristics of short buffeting time, the reliable and effective signal after buffeting elimination can be obtained by setting the buffeting time of the ARTU remote communication unit, so as to achieve the purpose of the anti-interference).

5.6 detailed explanation of analog input and output signals

The analog input AI signal has five information: “Fact” AI actual data、 “Statue” AI data、 “Style” input type (“0-20mA”、“4-20mA”、“0-5V”、“1-5V”)、 “High” AI input high point and “Low” AI input low point. The AI actual data and AI data meet the following formula:

$$\text{AI data}=(\text{AI actual data}-\text{Style_Low}*1000)*(\text{High}-\text{Low})/(\text{Style_High}-\text{Style_Low})+\text{Low};$$

Note:take “style” input type “4-20mA”as an example, Style_Low is equal to 4 and Style_High is equal to 20

The analog output AO signal has four information: “Statue” AO data、 “Style” output type (“0-20mA”、“4-20mA”、“0-5V”、“1-5V”)、 “High” AO output high point and “Low” AO output low point. The AO actual data and AO data meet the following formula:

$$\text{AO actual data}=(\text{Statue}-\text{Low})/(\text{High}-\text{Low})*(\text{Style_High}-\text{Style_Low})+\text{Style_Low};$$

Note:take “style” output type “4-20mA”as an example, Style_Low is equal to 4 and Style_High is equal to 20

6. Appendixes

6.1 Dial switch settings

6.1.1 Dial code definition

1	2	3	4	5	6	7	8	9	10
Address settings					Baud-rate settings		Mode settings	Communication mode settings	
1	0	0	0	0	0	0	0	0	0

6.1.2 Address settings

Dial code 1	Dial code 2	Dial code 3	Dial code 4	Dial code 5	Address
1	0	0	0	0	1
0	1	0	0	0	2

1	1	1	1	1	31
0	0	0	0	0	32

6.1.3 Baud-rate settings

Baud-rate	Dial code 6	Dial code 7
9600bps	0	0
4800bps	1	0
38400bps	0	1
19200bps	1	1

6.1.4 Mode settings

	Dial code 8	Note: Reset dial code 8 and the address or baud rate at the same time so as to work in a new communication mode.
Instrument local address and baud-rate settings	0	
Upper computer address and baud-rate settings	1	

6.1.5 Format settings

Mode	Dial code 9	Dial code 10
10 bits: 1 start bit, 8 data bits and 1 stop bit.	0	0
11 bits: 1 start bit, 8 data bits and 2 stop bits (reserved).	1	0
11 bits: 1 start bit, 8 data bits, even parity and 1 stop bit.	0	1
11 bits: 1 start bit, 8 data bits, odd parity and 1 stop bit.	1	1

Note: Dial switch status description: 1: OFF, 0: ON

6.2 Modbus function code description

6.2.1 Exception response format of the ARTU tetratele unit to an erroneous command received

Exception response format of the ARTU tetratele unit			
Address	Corresponding error function	Exception error code data	CRC check
BYTE	BYTE	BYTE	WORD
XX	XX (requested function code +80H)	01H, 02H, 03H, 04H	XXXX (CRC check value)

Exception codes are defined as follows:

- 01 Illegal function code (the received function code is not supported);
- 02 Illegal data location (the specified data location is out of the scope of the instrument);

03 Illegal data value (data values received to host are out of range of the corresponding address);

04 Slave station device failure (data values received to host sent are not currently allowed to be written).

6.2.2 Status of the used Modbus 01H/02H function

Reading required by the upper computer (MODBUS 01H/02H function)				
Address	Function	Address	Data	CRC check
BYTE	BYTE	WORD	WORD	WORD
XX	XX (01H/02H)	XXXX	XXXX	XXXX (CRC check value)

Lower machine reply (MODBUS 01/02 function)				
Address	Function	Data length	Data	CRC check
BYTE	BYTE	BYTE	N BYTE	WORD
XX	XX (01H/02H)	XX	XXXX.....	XXXX (CRC check value)

Lower machine abnormal reply (MODBUS 81H/82H function)			
Address	Corresponding error function	Exception error code data	CRC check
BYTE	BYTE	BYTE	WORD
XX	XX (81H/82H)	XX (02H address error, 03H data error)	XXXX (CRC check value)

6.2.3 Read by using Modbus 03 or 04 function

Reading required by the upper computer (MODBUS 03H/04H function)				
Address	Function	Start address	Data	CRC check
BYTE	BYTE	WORD	WORD	WORD
XX	XX (03H/04H)	XXXX	XXXX (N)	XXXX (CRC check value)

Lower machine reply (MODBUS 03H/04H function)				
Address	Function	Data length	Data	CRC check
BYTE	BYTE	BYTE	2*N BYTE	WORD
XX	XX (03H/04H)	XX (2*N)	XXXX.....	XXXX (CRC check value)

Lower machine abnormal reply (MODBUS 83H/84H function)			
Address	Corresponding error function	Exception error code data	CRC check
BYTE	BYTE	BYTE	WORD
XX	XX (83H/84H)	XX (02H address error, 03H data error)	XXXX (CRC check value)

6.2.4 Status of mandatory alarm by using Modbus 05H function

Reading required by the upper computer (MODBUS 05H function)				
Address	Function	Address	Data	CRC check
BYTE	BYTE	WORD	WORD	WORD
XX	XX (05H)	XXXX	0ff00H or 0000H	XXXX (CRC check value)

Lower machine reply (MODBUS 05 function)				
Address	Function	Address	Data	CRC check
BYTE	BYTE	WORD	WORD	WORD
XX	XX (05H)	XXXX (same as requested by the upper computer)	XXXX (same as requested by the upper computer)	XXXX (CRC check value)

Lower machine abnormal reply (MODBUS 85H function)			
Address	Corresponding error function	Exception error code data	CRC check
BYTE	BYTE	BYTE	WORD
XX	XX (85H)	XX (02H address error, 03H data error)	XXXX (CRC check value)

6.2.5 Write multiple data by using Modbus 10H function

Write multiple data as requested by the upper computer (MODBUS 16 (10H) function)						
Address	Function	Start address	Number of data	Data length	Data	CRC check
BYTE	BYTE	WORD	WORD	BYTE	2*N BYTE	WORD
XX	XX (10H)	XXXX	XXXX (n)	XX (2*n)	XXXX.....	XXXX (CRC check value)

Lower machine reply (MODBUS 16 (10H) function)				
Address	Function	Start address	Number of data	CRC check
BYTE	BYTE	WORD	WORD	WORD
XX	XX (10H)	XXXX	XXXX	XXXX (CRC check value)

Lower machine abnormal reply (MODBUS 90H function)			
Address	Corresponding error function	Exception error code data	CRC check
BYTE	BYTE	BYTE	WORD
XX	XX (90H)	XX (02H address error, 03H data error, 04 writing not allowed)	XXXX (CRC check value)

7 Communication Connection Modes

When multiple ARTUs are used in networking, a terminal matching resistor R shall be connected in parallel on A and B terminals of the last RS485 to ensure communication impedance matching, and the terminal matching resistance is generally between 120Ω-10kΩ, and may vary with different wiring. The above figure is the schematic diagram of using a three-core shielded line, the shielding lay is connected with ground, and the G1 terminals of each device are connected in parallel.

8 Debugging and Maintenance

8.1 Operation instructions

- 1) Check whether the power line is properly connected before powering on.
- 2) After powering on, ensure that the power indicator light (POWER) is lit, and that the RUN light (RUN) begins

to flicker at an interval of 1 second.

3) Communication establishment

- a) Correctly connect the RS485 bus and connect it to the upper computer.
- b) The upper computer issues commands according to the station number and baud rate of the module in the protocol format. At this time, the communication indicator light of the module flashes, indicating that the module has received the command of the upper computer and responded, that is, the communication has been established.

8.2 Debugging

- 1) Check whether the power supply is properly connected before powering on.
- 2) After powering on, observe whether the power light is on, if not, it means that the power is not connected.
- 3) Observe whether the RUN light flashes, if not, it means that the module does not run normally.
- 4) Only when the communication indicator light flashes will it indicate that the communication is established.
- 5) Set the query time interval of the upper computer. As the bus is the half-duplex mode, the upper computer should set an appropriate time interval, which should be determined according to the module reply command length and the baud rate. Improper time interval setting will lead to communication failure.

Jiangsu Acrel Electrical MFG Co.,Ltd.(Production Base)
Address : No31HongtuRd,NanzhaJiangyinJiangsu
Website: www.acrel.gr

Sales manager : Tim Ma
Tel/whatsapp/wechat : 8618761599716
E-mail : tim.ma@email.acrel.cn