

ARD2F Smart Motor Protector

Overview



ARD2F smart motor protectors can protect motors from many faults during the motor running and display the running state clearly and intuitively through LCD. The protector has RS485 remote communication interface and DC4-20mA analog output, which is convenient to form a network system together with control machines like PLC and PC.

Model Description

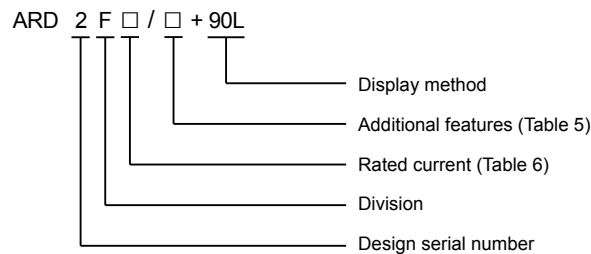

Table 5 Additional features

Additional Features		Code	Additional Features	Code
Start control (including 'K')		Q	Leakage Protection	L
Switch input		K	4~20mA analog output	M
Temperature protection		T	Loss of pressure (anti-shake)	SU (Including voltage and fault recording functions)
Alarm (programmable output)		J	SOE event record	SR
Communication Interface	Modbus-RTU	C	Voltage function (phase sequence, power, power factor)	U
	2 Modbus-RTU	2C		tE time protection

Note: 1. We recommend one 90L for one ARD2F.
 2. 'T' and '2C' cannot be selected at the same time.
 3. 'Q' is necessary when 'SU' is selected, 'SU' includes 'SR' and 'U'.

Table 6 Rated current

Rated Current (A)	Ratio Setting	Transformer Primary Side Turns	Setting Current Range (A)	Motor Power (kW)
1	Need	5	0.1~999.9	0.12~440
5		1	0.1~999.9	0.12~440
1.6	No need	1	0.4~1.6	0.12~0.55
6.3		1	1.6~6.3	0.75~2.2
25		1	6.3~25	3~11
100		1	25~100	15~45
250		1	63~250	55~132
800		1	250~800	160~440

Technical parameter

Table 7

Technical parameter	Value	
Auxiliary power supply	AC85~265V/DC100~350V,power consumption 15VA	
Rated voltage	AC380V/AC660V,50Hz/60Hz	
Rated current	1A(0.1A-999.9A)	Small special current transformers
	5A(0.1A-999.9A)	
	1.6A(0.4A-1.6A)	
	6.3A(1.6A-6.3A)	
	25A (6.3A-25A)	
	100A (25A-100A)	
	250A (63A-250A)	Special current transformers
	800A (250A-800A)	
Relay output contactor, rated negative capacity	5 channels,AC 250V 6A	
Switching input	9 channels,opto-coupler isolation	
Communication	RS485(Modbus-RTU)	
Environment	Operation temperature	-10℃~55℃
	Storage temperature	-20℃~65℃
	Relative humidity	5%~95% (No condensation)
	Altitude	≤2000m
Class of pollution	Level 2	
Protection level	Main module IP20,display unit IP45	
Installation category	Class III	

Dimensions and Installation (unit: mm)

■ Appearance and size of mounting hole

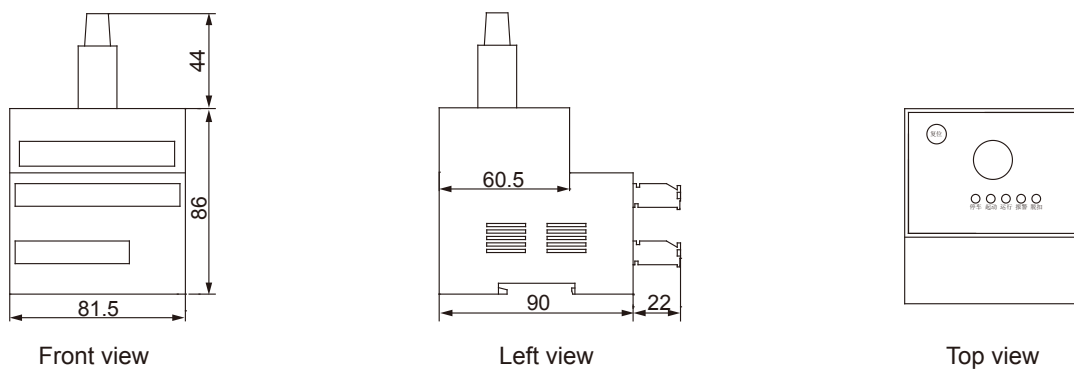

■ Installation dimension of protector display unit

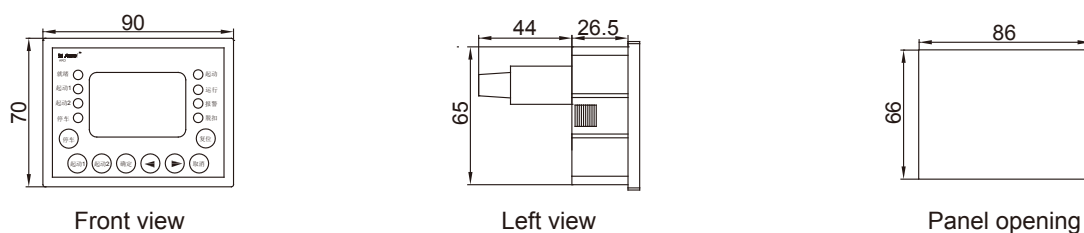

■ Installation dimensions of transformer

See the ARD2 Transformer Installation Dimension

■ Anti sway electric module

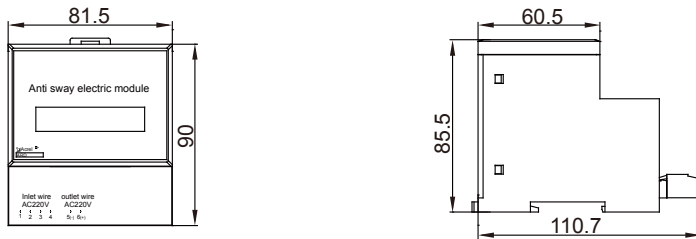

■ AC380 power module

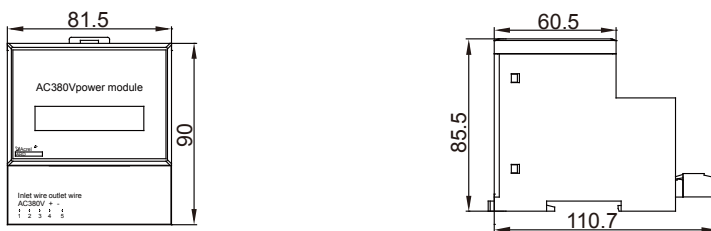

Wiring

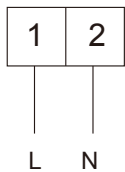

Auxiliary power supply

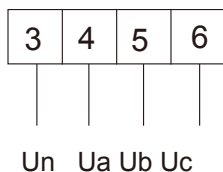

Voltage signal input

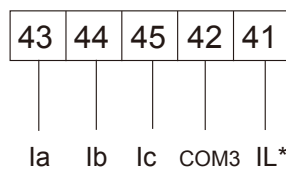

Current signal input

Leakage current input

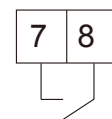

Starting 1

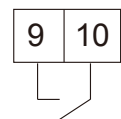

Starting 2

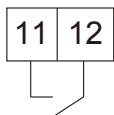

Alarm
(DO3 programmable)

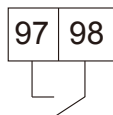

Trip
(DO4 programmable)

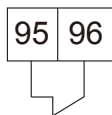

Trip

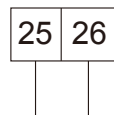

A B
RS485

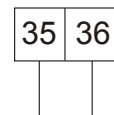

AO+ AO-
Analog output

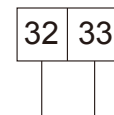

T1 T2
PTC/NTC resistance input

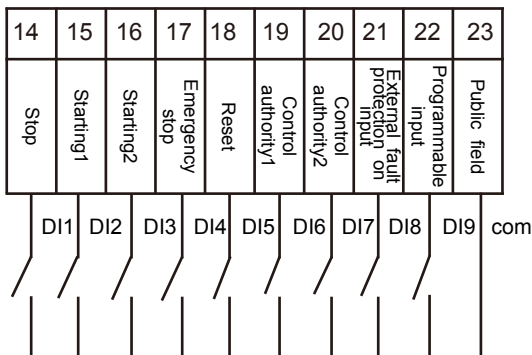



Switching input

Display and Parameters Setting

■ Operation panel instruction

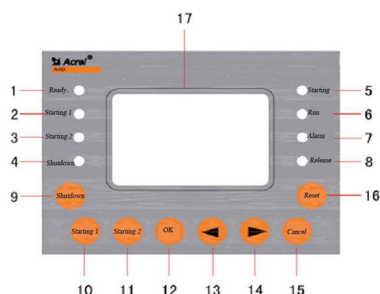
Users can observe the running status of motor through the LED indicating lamp and Chinese LCD on display unit and start, stop, reset and set parameters through the buttons.



No.	Name	Status	Function Description
1	Ready LED	On	When it is on, it indicates that the protector is in normal state and the motor can be started.
2	Starting 1 LED	On	When it is on, it indicates that the protector starting 1 relay closed
3	Starting 2 LED	On	When it is on, it indicates that the protector starting 2 relay closed
4	Stopping LED	On	When it is on, it indicates that the motor is in stopping status.
5	Starting LED	On	When it is on, it indicates that the motor is in starting status.
6	Running LED	On	When it is on, it indicates that the motor is in running status.
7	Alarm LED	On	When it is on, it indicates that the protector alarm relay has taken action.
8	Trip LED	On	When it is on, it indicates that the protector trip relay has taken action.
9	Stop button	Hold down	Trip starting 1, starting 2 relays
10	Starting 1 button	Hold down	Operate starting 1 relay to make it closed
11	Starting 2 button	Hold down	Operate starting 2 relay to make it closed
12	Confirm button	Hold down	Enter the menu and modify the parameters
13	 key(left)	Hold down	Turn on the menu; data transfer; view event log
14	 key(right)	Hold down	Turn down menu; modify data;
15	Cancel button	Hold down	Exit the menu; cancel operation; lighten backlight
16	Reset button	Press	Reset the protector
17	LCD display screen		Display various measured parameters and setting parameters

Parameter setting

Display menu contents

1. A, B, C three-phase current and unbalance percentage
2. Three-phase current and the percentage of three-phase average current to the set rated current
3. Uab, Ubc, Uca line voltage
4. Active power P, apparent power S, power factor PF;
5. Iav three-phase average current, Uav three-phase average voltage, Id earth leakage current, frequency F;
6. Heat capacity percentage
7. Thermal resistance value:
8. Route 5 relay input: 1-Starting, 2; 3-Alarm (programmable) ;
4- Trip (Programmable); 5- Trip
9. Route 9 DI status.

Users can press the “” key(right) on the display unit to display the selection of menu interface.

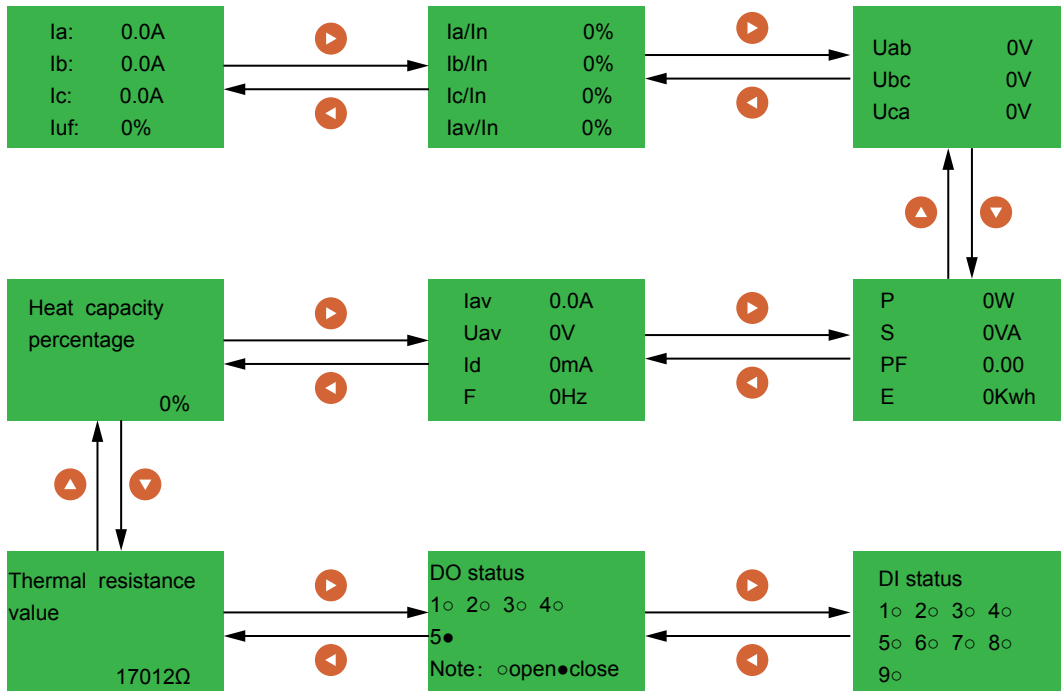

Overview of menu

Press the “Confirm” button, then password input interface comes out. users can enter the parameter setting menu after inputting the password (initial password is 0001, universal password is 0008)

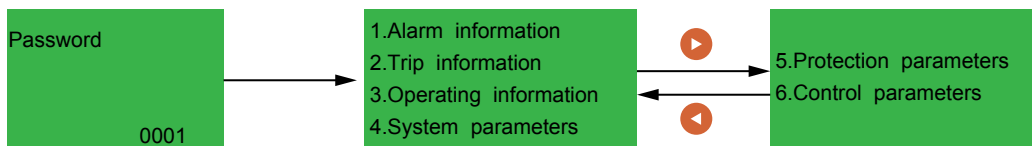

◆ Overview of submenus

① Alarm information

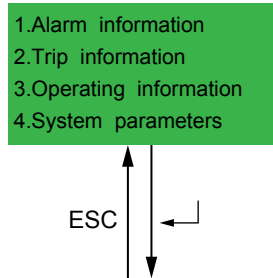

1.Overload alarm	N
2.Phase failure alarm	N
3.Under load alarm	N
4.Temperature alarm	N
5.Unbalance alarm	N
6.Earthing/Earth leakage alarm	N
7.External alarm	N
8.Starting alarm	N

9.Under voltage alarm	N
10.Over voltage alarm	N
11.Pei-rotor alarm	N
12.Blocking alarm	N
13.Overpower alarm	N
14.Under power alarm	N
15.Phase sequence alarm	N
16.Short-Circuit alarm	N

② Trip information

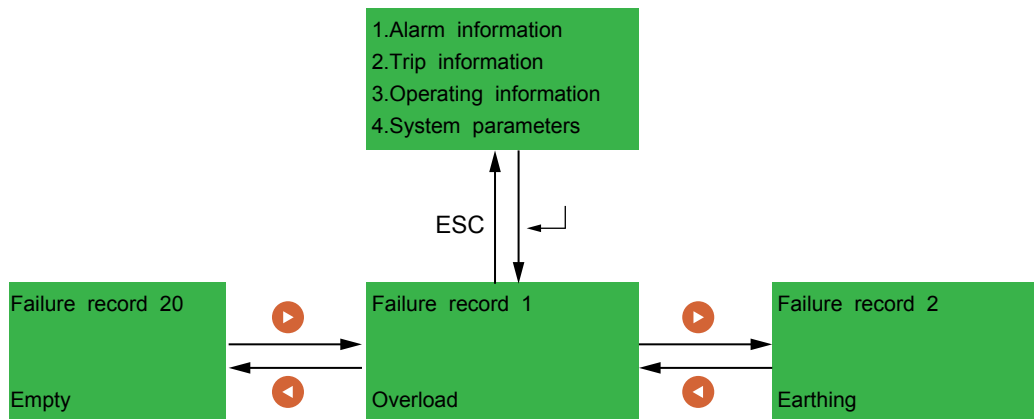

③ Operation information

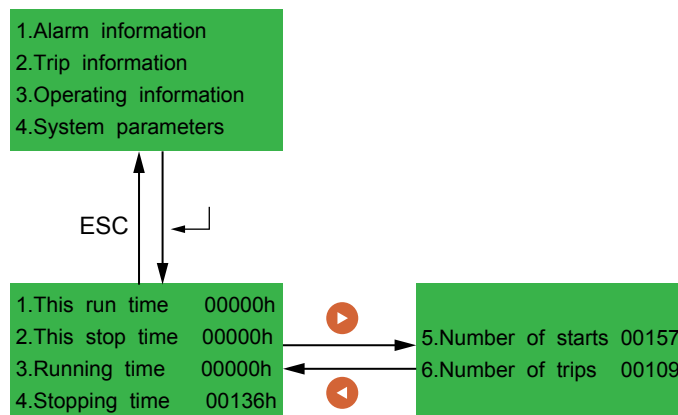

④ System parameters

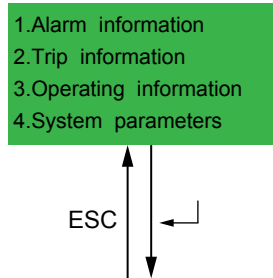

1.Baud rate	2400、4800、9600、19200、38400	9600	bps
2.Postal address	1-247	1	
3.Password	0-9999	1	
4.Motor Type	General motor, safety-increased motor	Common motor	
5.Transmission Type	la, lb, le, lay, Uab, Ubc, Uca, Uay, PTC, heat Capacity, P, F	lay	
6.transmission ratio	1-8	2	
7.backlight lit	On/off	OFF	
8.System voltage	380、660	380	V
9.Rated frequency	45-65	50	
10.Rated power	0.4-1.6 1.6-6.3 6.3-25 25-100 63-250 250-800	1056、 4158、 16500、 66000、 165000、 480000	w
11.CT ratio	1-1000	1	
12.Local speed switch	On/off	OFF	
13.fundamental wave switch	On/off	OFF	
14.Software Version			

⑤ Protection parameters

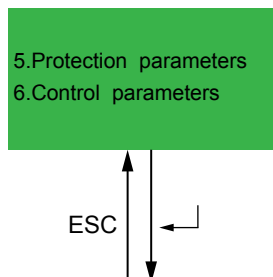

1.Starting protection	Starting time	0.1-999.9	10.0	s
	Alarm	On/off	OFF	
	Trip	On/off	ON	

2. Overload protection	Rated current of motor	0.4-1.6	1.6	A
		1.6-6.3	6.3	
		6.3-25	25.0	
		25-100	100	
		63-250	250	
		250-800	800	
	Trip class	1、 2、 3、 5、 10、 15、 20、 25、 30、 35、 40	5	Level
	Alarm threshold value	1-99%	85	%
	Alarm	On/off	OFF	
	Trip	On/off	ON	
Overload automatic reset	On/off	OFF		
3. Under load protection	Cooling time	1-30	30	min
	Alarm threshold value	10-99%	70	%
	Trip threshold value	10-99%	50	%
	Trip delay	0.1-600	5.0	s
	Alarm	On/off	OFF	
	Trip	On/off	OFF	
4. Phase failure protection	Trip delay	0.1-600	1.0	s
	Alarm	On/off	OFF	
	Trip	On/off	ON	
5. Phase sequence protection	Trip delay	0.1-600	1.0	s
	Alarm	On/off	OFF	
	Trip	On/off	ON	
6. Unbalance protection	Alarm threshold value	10-80%	20	%
	Trip threshold value	10-80%	30	%
	Trip delay	0.1-600	5.0	s
	Alarm	On/off	OFF	
	Trip	On/off	OFF	
7. Earthing / Earth leakage	Transformer input	On/off	OFF	
	Earthing alarm threshold value	20-100%	20	%
	Earthing trip threshold value	20-100%	50	%
	Trip delay	0.1-600	0.1	s
	Earth leakage alarm current	100-1000	200	mA
	Earth leakage trip current	100-1000	300	mA
	Trip delay	0.1-600	0.5	s
	Alarm	On/off	OFF	
	Trip	On/off	OFF	

8.Short-Circuit Protection	Alarm threshold value	400-700% max. measurable overload times	400	%
	Trip threshold value	400-700% max. measurable overload times	500	%
	Trip delay	0.1-600	0.1	s
	Alarm	On/off	OFF	
	Trip	On/off	OFF	
9.Over voltage protection	Alarm threshold value	110-150%	110	%
	Trip threshold value	110-150%	120	%
	Trip delay	0.1-600	5.0	s
	Alarm	On/off	OFF	
	Trip	On/off	OFF	
10.Under voltage protection	Alarm threshold value	55-90%	90	%
	Trip threshold value	55-90%	80	%
	Trip delay	0.1-600	5.0	s
	Alarm	On/off	OFF	
	Trip	On/off	OFF	
11.Pei-rotor protection	Alarm threshold value	100-700%	500	%
	Trip threshold value	100-700%	600	%
	Trip delay	0.1-600	5.0	s
	Alarm	On/off	OFF	
	Trip	On/off	OFF	
12.Blocking protection	Alarm threshold value	100-700%	150	%
	Trip threshold value	100-700%	250	%
	Trip delay	0.1-600	5.0	s
	Alarm	On/off	OFF	
	Trip	On/off	OFF	
13.Overpower protection	Alarm threshold value	100-700%	150	%
	Trip threshold value	100-700%	250	%
	Trip delay	0.1-600	5.0	s
	Alarm	On/off	OFF	
	Trip	On/off	OFF	
14.Under power protection	Alarm threshold value	0-100%	80	%
	Trip threshold value	0-100%	50	%
	Trip delay	0.1-600	5.0	s
	Alarm	On/off	OFF	
	Trip	On/off	OFF	

15.Temperature protection	PTC type	On/off	ON	
	Return resistance value	0 closed 1000-30000	0	Ω
	Alarm resistance value	100-30000	1600	Ω
	Trip resistance value	100-30000	3600	Ω
	Trip delay	0.1-600	5.0	s
	Alarm	On/off	OFF	
	Trip	On/off	OFF	
16.External fault	Trip delay	0.1-600	5.0	s
	Alarm	On/off	OFF	
	Trip	On/off	OFF	

⑥ Alarm information

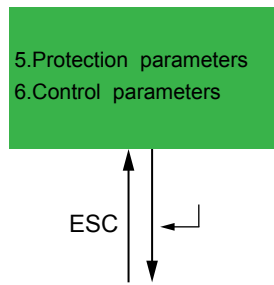

1.Control authority	Switching input	Local, on-site, remote I. full-controlled	Full-controlled	
2.Starting Contro	Starting Mode	Protection mode, manual mode, two-step mode, two-speed mode	protection mode	
3.Self-start	Starting - delay	0.1-600	3.0	s
	Self-start Mode	Reset/ start	Starting	
	Self-start delay	0.1-600	5.0	s
	Self-start control	On/off	OFF	
4.Loss voltage restarting	voltage setting	75-95%	80	%
	Immediately restarting power failure time	0.1-0.5	0.1	s
	Allowable time (min)	0.5-10.0	5.0	s
	Restarting delay	1.0-60.08	30.0	s
5.Reflow inspection	Controls	0 OFF, 1 start 1, 2 start2	OFF	
	Delay setting	0.1-600		s
6.D03 programmable Setting	Controls	On/off	OFF	
	Programmable setting	1-Start 1, 2-Start 3-Alarm fault output, 4-Trip fault output, 5-Device self-checking output 6-Device power output, 7-Stopping state ready 8-Running state output, 9-DI control output, 10-Bus control	3	

7.D04 programmable Setting	Action time setting	0-250	0.1	s
	Programmable setting	1-Starting1, 2-Start 2, 3-Alarm fault output, 4-Trip fault output, 5-Device self-checking output 6-Device power output, 7-Stopping state ready 8-Running state output, 9-DI control output, 10-Bus control	3	
	Action time setting	0-250	0.1	s
	Trip fault setting	0-65535	65535	
8.DI9 programmable Setting	DI9 programmable setting	1.Common DI 2.Start 1(direct start, turn left, low speed) 3.Start 2(turn right,high speed), 4.Shutdown 5.Resetting, 6.Emergency shutdown 7.External fault 8.Start/stop, 9.Control authority 1 10.Control authority 2 11.Two-wire start-stop		
9.TEST	D02	On/off	OFF	
	D03	On/off	OFF	
	D04	On/off	OFF	
	D05	On/off	OFF	

Jiangsu Acrel Electrical MFG Co.,Ltd.(Production Base)
Address : No31HongtuRd,NanzhaJiangyinJiangsu
Website: www.acrel.gr

Sales manager : Tim Ma
Tel/whatsapp/wechat : 8618761599716
E-mail : tim.ma@email.acrel.cn