

Headquarters: Acrel Co., Ltd.

Address: 253, Yulv Road, Madong Industrial Park, Jiading, Shanghai

Tel.: +86-(0)21-69158300, 69158301, 69158302

Fax: +86-(0)21-69158303

Service hotline: +86-800-8206632

P.C.: 201801

E-mail: ACREL001@vip.163.com

Production base: Jiangsu Acrel Electric Appliances Manufacturing Co., Ltd,

Address: 5, Dongmeng Road, Dongmeng Industrial Park, Nanzha Town, Jiangyin City

Tel.: +86-(0)510-86179966, 86179967, 86179968

Fax: +86-(0)510-86179975

P.C.: 214405

E-mail: JY-ACREL001@vip.163.com

Smart Motor Protector ARD Series

User's Manual V2.5

Acrel Co., Ltd.

Declaration

The copyright is the property of Acrel. Any information in any paragraph or section cannot be extracted, copied or otherwise reproduced or propagated. Otherwise offenders shall take all consequences.

All rights are reserved.

Acrel reserves the right to modify the product specifications herein without notification. Please consult the local agent about the latest specifications before placing a purchase order.

Contents

Smart Motor Protector ARD2 Series

1. Overview.....	1
2. Product type.....	1
3. General technical index.....	2
4. Overall dimensions and installation.....	3
5. Display and user programming.....	5
6. Wiring Mode.....	12
7. Communication protocol.....	12
8. Typical application solutions.....	19
9. Setting and instructions of protection functions.....	21
10. Cautions.....	23
11. Order sample.....	24

Smart Motor Protector ARD2F Series

1. Overview.....	25
2. Product type.....	25
3. General technical index.....	26
4. Overall dimensions and installation.....	26
5. Display and user programming.....	29
6. Wiring Mode.....	31
7. Communication protocol.....	33
8. Typical application solutions.....	45
9. Setting and instructions of protection functions.....	51
10. Cautions.....	62
11. Order sample.....	63

Smart Motor Protector ARD3 Series

1. Overview.....	64
2. Product type.....	64
3. General technical index.....	66
4. Outline dimensions and installation.....	66
5. Display and parameter setting.....	70
6. Wiring Mode.....	72
7. Communication protocol.....	73
8. Typical application solutions.....	91
9. Setting and instructions of protection functions.....	94
10. Cautions.....	107
11. Order sample.....	108

Warning. User must set protective functions and parameters in accordance with conditions of your motor before using the protector.

1. Overview

Smart Motor Protector ARD2 Series (hereinafter referred to as Protector) utilizes advanced single chip technology and is featured in the strong anti-interference, stable and reliable running, digitalization, intelligence and networking. The protector can protect the motor from timeout startup, overload, phase failure, unbalance, under-load, earth leakage, blocking, short circuit, external fault and other abnormalities during the running and provide the SOE fault event recorder to help maintenance staff find causes. It is applicable for coal mines, petrochemical industry, metallurgical industry, power industry, shipbuilding, civil building and other fields. It is equipped with the RS485 remote communication interface and the DC4-20mA analog output, which is convenient to form a network system together with control machines like PLC and PC to realize the remote monitoring of motor.

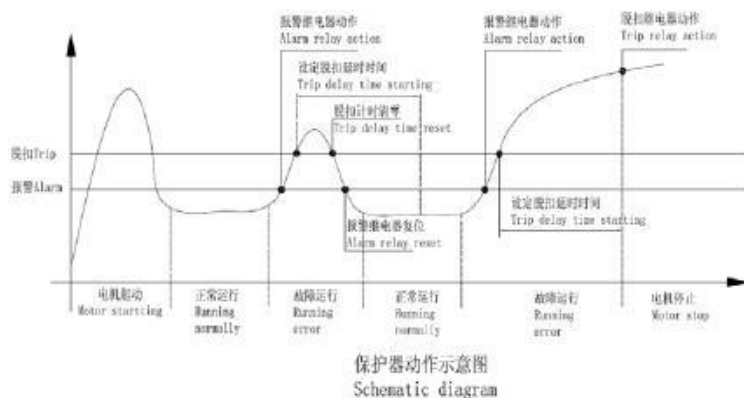

2. Product type

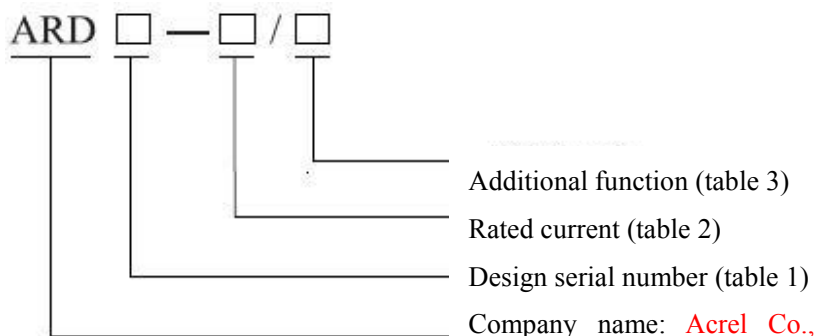

Table 1

Design serial number	Specification	Design serial number	Specification
2	LED display	2L	LCD display

Table 2

Rated current of current transformer, A	Ratio setting	Number of turns at the primary side of transformer	Range of setting current I_s , A	Power of motor, kW
1	Yes	5	0.1~9999	0.12~440
5		1	0.1~9999	0.12~440
1.6	No	1	0.4~1.6	0.12~0.55
6.3		1	1.6~6.3	0.75~2.2
25		1	6.3~25	3~11
100		1	25~100	15~45
250		1	63~250	55~132
800		1	250~800	160~440

Table 3

Additional function	Code	Additional function	Code
Communication interface	C	2-way switching input, 1-way relay output (programmable 3)	K
Leakage protection	L	SOE event recorder	SR
Analog output 4-20mA	M	Alarm output (programmable 2)	J

3. General technical index

Table 4

Technical parameters	Technical specification	
Auxiliary power supply of protector	AC85V~265V/DC100V~350V, power consumption $\leq 7VA$	
Rated working voltage of motor	AC380V/AC660V, 50H/60Hz	
Rated working current of motor	1A (0.1 ~9999)	Small specific current transformer
	5A (0.1 ~9999)	
	1.6A (0.4A—1.6A)	
	6.3A (1.6A~6.3A)	
	25A (6.3A~25A)	
	100A (25A~100A)	
	250A (63A-250A)	Specific current transformer
800A (250A~800A)		
Relay output contactor, rated load capacity	4-way, AC250V, 3A, DC30V, 3A	
Switching input	2-way, optical isolation	
Communication	RS485 Modbus	
Volume of SOE event recorder	8 events	
Environment	Working temperature	-10°C-55°C
	Storage temperature	-20°C-65°C
	Relative humidity	5%-95%, no dew
	Altitude	$\leq 2000m$
Class of pollution	2	
Protection level	IP20	

4. Overall dimensions and installation

4.1 Installation dimensions of protector

Unit: mm

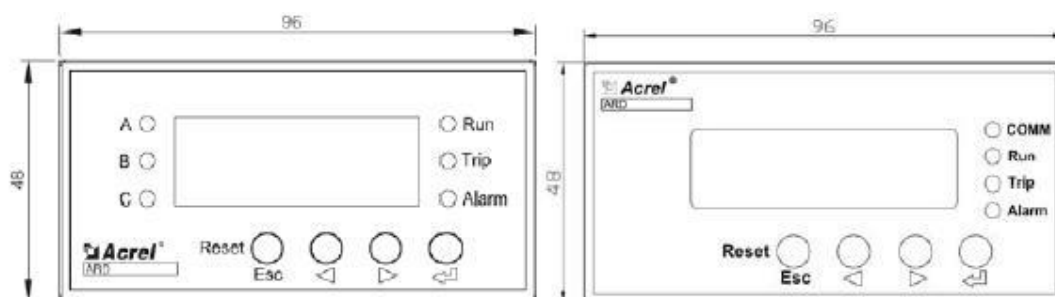

LED tube

LCD

Front view

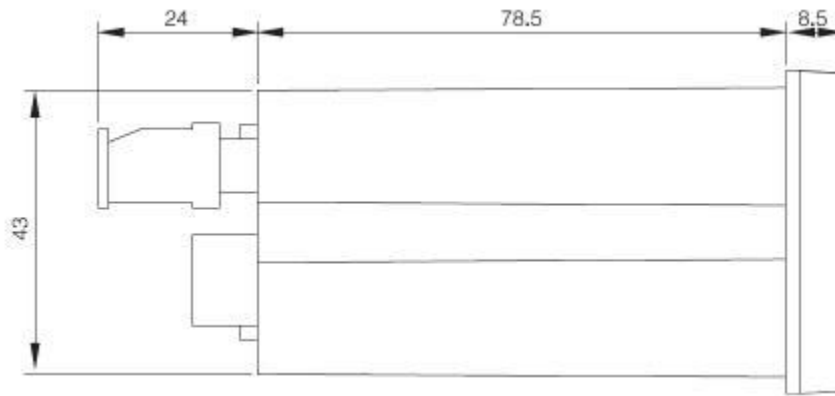

Left view



Opening on the surface
Main body

4.2 Installation dimensions of transformer

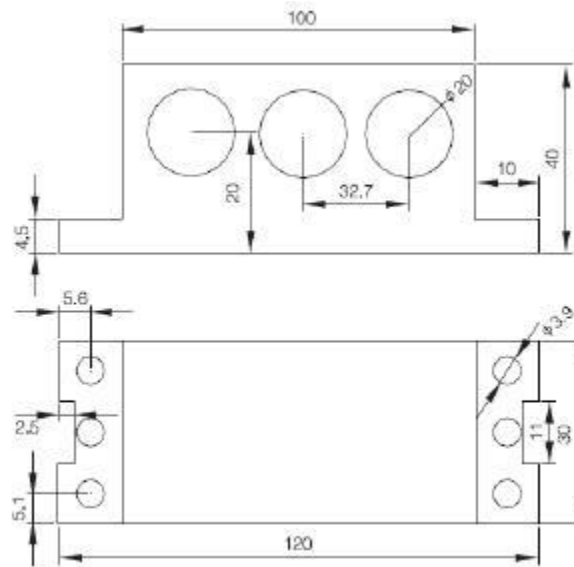

Current Transformer (0.1A-100A)

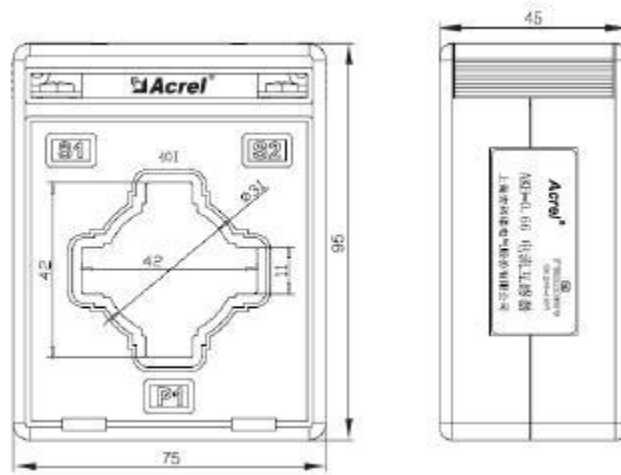

Current Transformer (63A-250A)

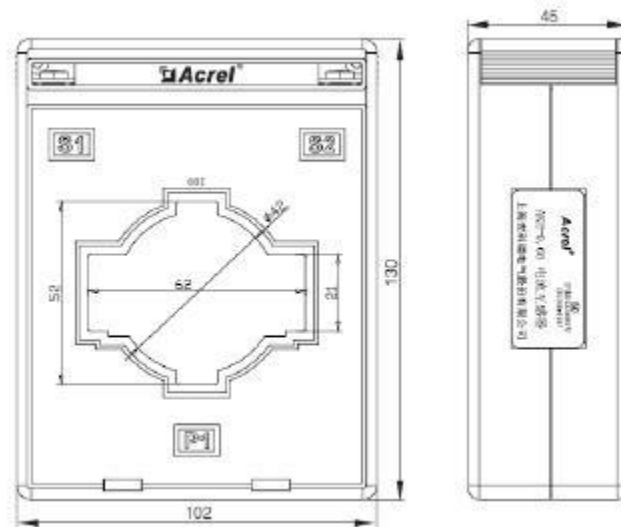

Current Transformer (250A-800A)

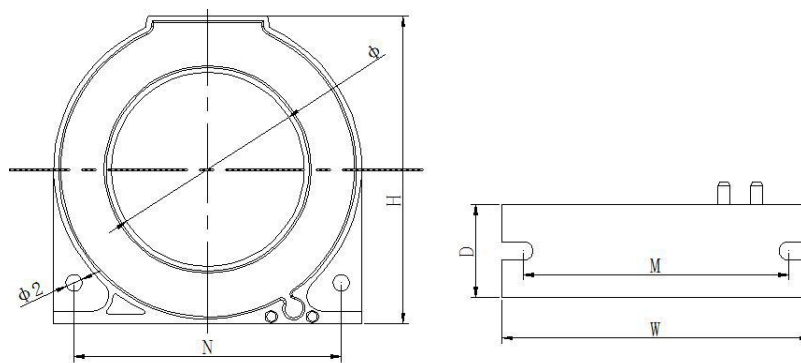

Zero sequence current transformer

Size	Current specification (A)	Outline dimension(mm)			Perforation Size(mm)	Installation Size(mm)			Tolerance (mm)	Weight (g)
		W	H	D	Φ	M	N	Φ2		
L-45	16-100	75	75	22	46	65	65	4	±1	200±10
L-80	100-250	120	120	23	81	105	105	4		380±20
L-150	400-800	196	205	24	150	175	180	6		850±50

4.3 Installation method

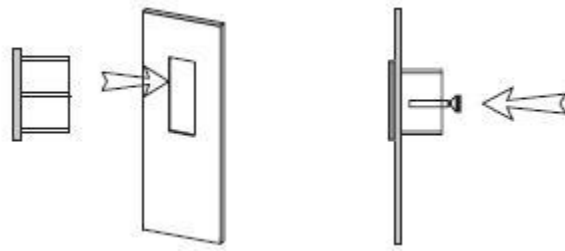

Installation of main body

5. Display and user programming

5.1 Description of LED display

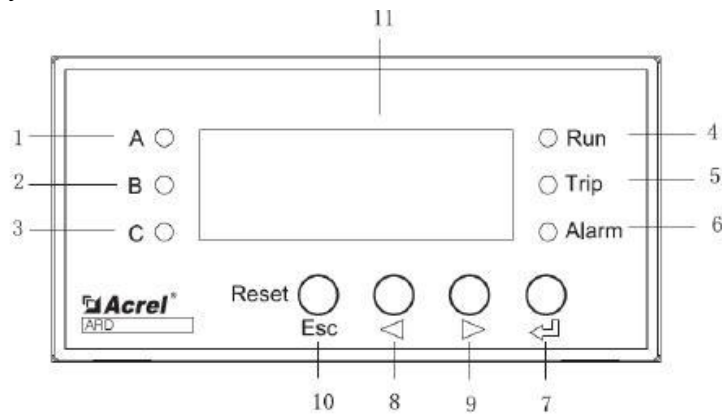

Table 5

No.	Name	State	Function Description
1	indicator light	On	When it is on, it indicates that 11 shows the current of phase A.
2	indicator light	On	When it is on, it indicates that 11 shows the current of phase B.
3	indicator light	On	When it is on, it indicates that 11 shows the current of phase C.
4	indicator light	On	When it is on, it indicates that the motor is running.
5	indicator light	On	When it is on, it indicates that the trip relay is enabled.
6	indicator light	On	When it is on, it indicates that the protector has sent an alarm.
7	← key	press	Select the operating function or return to the last menu.
8	◀ key (left)	press	Review events, reduce the digital value or shift
9	▶ key (right)	press	Review the data or increase the digital value
10	Esc/Reset key	press	Exit from the menu, cancel the operation, reset the protector or test the relay
11	4-bit LED	0000	Show the measured value
Note	Phase A, B& C indicator light	On	When all light are on, it indicates that 11 shows the average current of three phases.

5.1.1 User programming







Press the  key on the protector until “P001” is indicated. Press the  key (left) and the  key (right) to select options on the menu. When the cursor moves to the desired option, press the  key to set the value field. Press the  key to select data bits and the  key (right) to increase the value. After setting, press the  key to save the parameter. Then press the ESC key to exit from the menu. Indicate the enabling state of protective functions with ON and disabling state with OFF. Refer to the following table for parameter setting:

Table 6

Parameter	Type of setting	Default value	Setting range	Unit
P001	Overload/ full-load rated current setting	1	0.1-999	A
		5	0.1-999	
		1.6	0.4-1.6	
		6.3	1.6-6.3	
		25	6.3-25	
		100	25-100	
		250	63-250	
		800	250-800	
P002	Trip level setting	5	1, 2, 3, 5, 10, 15, 20, 25, 30, 35, 40	Level
P003	Starting time	10	0.1-999.9	Second
P004	Overload alarm threshold setting	85	1-99%	%
P005	Phase failure trip delay	1	0.1-600.0	s
P006	Leakage fault current setting	300	30-1000	Milliamperere
	Earthing percentage setting	80	1-100%	%
P007	Earthing/ leakage fault trip delay setting	0.5	0.1-600.0	Second
P008	Under-load threshold setting	50	10-99%	%
P009	Under-load trip delay setting	5.0	0.1-600.0	Second
P010	Unbalance threshold setting	30	10-80%	%
P011	Unbalance trip delay setting	5.0	0.1-600.0	Second
P012	Unbalance alarm threshold setting	20	10-80%	%
P013	Alarm enabling On/Off	OFF	OFF/ON	Overload alarm
P014		OFF	OFF/ON	Unbalance alarm
P015	Trip enabling On/off	ON	OFF/ON	Overload trip
P016		OFF	OFF/ON	Earthing/leakage trip
P017		OFF	OFF/ON	Under-load trip
P018		ON	OFF/ON	Phase failure trip
P019		ON	OFF/ON	Starting time-out trip
P020		OFF	OFF/ON	Short-circuit trip
P021		OFF	OFF/ON	Blocking trip
P022		OFF	OFF/ON	Unbalance trip
P023		OFF	OFF/ON	External fault trip
P024		External fault trip delay setting	5.0	0.1-600.0

P025	Programmable 1 output setting setting	11	1. alarm; 2. trip; 3. overload; 4. short circuit; 5. earthing/ leakage trip; 6. phase failure; 7. external fault; 8. remote starting; 9. leakage alarm; 10. short circuit and earthing protection; 11. short circuit, leakage/ earthing; 12. short circuit, leakage/earthing (pulse: 1s)	
P026	Overload cooling time	0	0: manual reset; 1-30min: automatic reset	Second
P027	Blocking value setting	250	100~700	%
P028	Delay of blocking trip setting	5.0	0.1~600.0	Second
P029	Baud rate of MODBUS setting	9600	2400, 4800, 9600, 19200, 38400	bps
P030	MODBUS address setting	1	1~247	
P031	Locked-rotor threshold setting	600	100~700	%
P032	Locked-rotor trip delay setting	5.0	0.1-600.0	Second
P033	Locked-rotor release On/off	ON	OFF/ON	
P034	Short-circuit threshold setting	400	400-720	%
P035	Short-circuit trip delay	0.1	0.1-600.0	Second
P036	Enabling of residual current transformer	OFF	OFF/ON	
P037	Programmable 2 output setting	2	Same as output setting of programmable 1	
P038	Programmable 3 output setting	2	Same as output setting of programmable 1	
P039	CT transformation ratio	1	1-9999	

LCD parameters are set as follows:

No.	Function		Type of setting	Setting range	Default value	Unit
I	Alarm text					
II	Trip text					
III	Running text	1. Running of current cycle				h
		2. Stop of current cycle				h
		3. Running time				h
		4. Stopping time				h
		5. Number of starts				
		6. Number of trip				
IV	System parameters	Baud rate		2400, 4800, 9600, 19200, 38400	9600	bps
		Communication address		1-247	1	
		Bright backlight		ON/OFF	OFF	
		Transformation ratio transmission		1-8	2	
		Fundamental wave		ON/OFF	OFF	

			Version of software				
V	Protective parameters	Starting protection	Starting time	0.1-99.9	10.0	Second	
			Trip	ON/OFF	ON		
		Overload protection	Rated current of motor	1.6-6.3 6.3-25 25-100 63-250 250-800	6.3 25.0 100 250 800	A	
			Trip level	1, 2, 3, 5, 10, 15, 20, 25, 30, 35, 40	5	Level	
			Alarm threshold	1-99%	85	%	
			Alarm	on/off	OFF		
			Trip	on/off	ON		
			Cooling time	0: manual reset: 1-30min: automatic reset	30	Second	
		Under-load protection	Trip threshold	10-99%	50	%	
			Trip delay	0.1-600.0	5.0	Second	
			Trip	on/off	OFF		
		Phase failure protection	Trip delay	0.1 -600.0	1.0	Second	
			Trip	ON/OFF	ON		
		Unbalance protection	Alarm threshold	10-80%	20	%	
			Trip threshold	10-80%	30	%	
			Trip delay	0.1-600.0	5.0	Second	
			Alarm	ON/OFF	OFF		
			Trip	ON/OFF	OFF		
		Earthing/leakage protection	Enabling of transformer	ON/OFF	OFF		
			earthing trip threshold	1~100	80	%	
			leakage trip threshold	100~1000	300	Milliamperere	
			Trip delay	0.1~600. 0	0.5	Second	
			Trip	ON/OFF	ON		
		Short circuit protection	Trip threshold	Max. measurable overload 400%-700%	500		
			Trip delay	0.1~600. 0	0.1		
			Trip	ON/OFF	ON		
		Locked-rotor protection	Locked-rotor threshold	100~700	600	%	
			Locked-rotor trip delay	0.1~600.0	5.0	Second	
			Locked-rotor trip	OFF/ON	ON		
		Blocking protection	Blocking threshold	100%-700%	250	%	
			Trip delay	0.1~600.0	5.0	Second	
			Trip	ON/OFF	ON		

		External fault protection	External fault trip delay	0.1-600.0	5.0	Second
			Trip	ON/OFF	OFF	
IV.	Control parameters	Setting of programmable 1		1. alarm; 2. trip; 3. overload; 4. short circuit; 5. earthing/ leakage trip; 6. phase failure; 7. external fault; 8. remote starting; 9. leakage alarm; 10. short circuit and earthing protection; 11. short circuit, leakage/ earthing; 12. short circuit, leakage/earthing (pulse: 1s)	11	
		Setting of programmable 2		Same as output setting of programmable 1	2	
		Setting of programmable 3		Same as output setting of programmable 1	2	
		Test	DO1	ON/OFF	OFF	
			DO2	ON/OFF	OFF	
DO3	ON/OFF		OFF			
DO4	ON/OFF		OFF			

5.1.2 Data view

View the measurement data. User can press the  key (right) to view the average current of three phases, the current of individual phase (phase A, B or C), the leakage current or earthing percentage and switch input.







View the event record. User can press the  key. When the LED shows *EUT 1*, it indicates the event 1 (for the last trip of protector). Press the  key. Then LED shows *CAUS*. Press the  key again to view the cause. Press the Esc to return to the last menu. User can view the *month* (month), *day* (day), *hour* (hour), *minute* (minute) and *sec* (second) of trip action with  key. User can also view other events with  key or  key when the LED shows *EUT 1*. The protector records the latest eight trip events. The meaning of event record is given in the table 7.





Table 7 Meaning of Event Record

Code of communication fault	Message	Fault cause
12	<i>Stot</i>	Starting time-out
1	<i>HEAT</i>	Overload
3	<i>UdCU</i>	Under-load
9	<i>CU 1b</i>	Current unbalance
4	<i>LoPh</i>	Phase failure
7	<i>StAL</i>	Locked-rotor
8	<i>JA</i>	Blocking
2	<i>oUdF</i>	Earthing/leakage
16	<i>Shor</i>	Short circuit
11	<i>oUTE</i>	External fault

Test if the relay works normally.

Method 1. Press and hold the ESC for 8s and check if the relay is enabled. (The operation is available for both LED tube

and LCD designs.)

Method 2. It is only available for LCD design. Set the Remote Starting (0008 by pressing the  key and the  key to enter the Control Program) for three programmable relay. Then press the  key and the  key to enter the Control Program and start the test.

Note: For method 1, press the ESC to restore to the original state of relay after test.

For method 2, it is necessary to restore to the original state of relay and reset the programmable setting after test.

5.2 Description of LCD

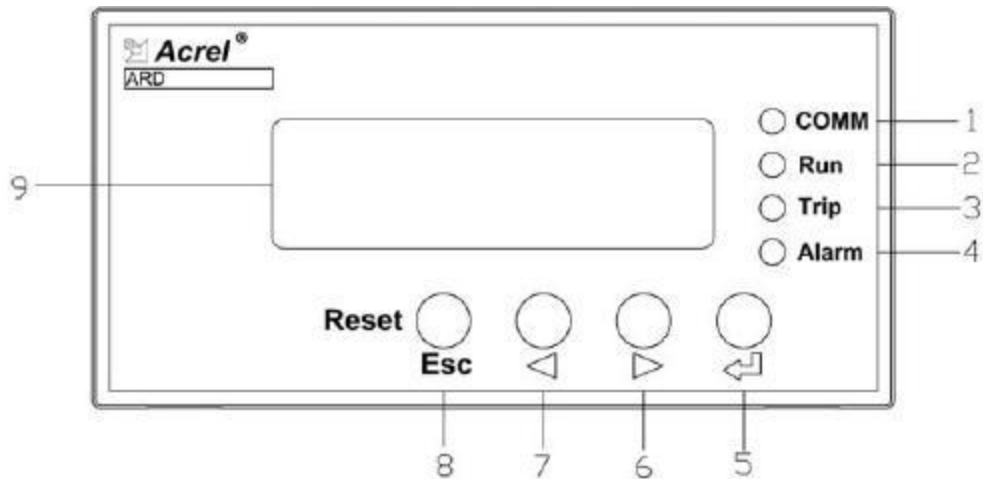





Table 8

No.	Name	State	Function
1	Indicator light	on	When it is on, it indicates that the communication bus is loading data.
2	Indicator light	on	When it is on, it indicates that the motor is running.
3	Indicator light	on	When it is on, it indicates that the trip relay is enabled.
4	Indicator light	on	When it is on, it indicates that the protector has sent the alarm.
5	 key	Press	Select the operating function or return to the last menu.
6	 key (left)	Press	Review events, reduce the digital value or shift
7	 key (right)	Press	Review the data or increase the digital value
8	Esc/Reset key	Press	Exit from the menu, cancel the operation, reset the protector or test the relay
9	LCD		Show the measured value

5.2.1 User programming

Press the  key on the protector to enter the request and setting screen. Refer to the operation of LED tube for operations of LCD. Set parameters in accordance with the table 6.

5.2.2 Data view

User can press the  key (right) to see different display menus. Display menus contain following information:

1. current of phases (phase A, B and C) and percentage of unbalance (I_{uf})
2. ratio of working current to rated current in percent
3. average current of three phases (phase A, B and C) (I_{av}), percentage of thermal capacity (Heat), ratio of average three current of phases (phase A, B and C) to rated current (I_{av}/I_n) and earthing ratio (I_d/I_n) or leakage current (I_d)
4. 2-way DI state

5. 4-way relay output: 1-trip; 2-short-circuit/earthing trip (programmable 1)
3-alarm (programmable 2); 4- programmable 3

6. Wiring Mode

6.1 Power and current signal

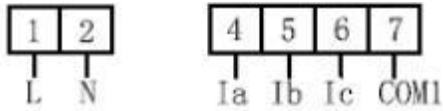

Auxiliary power supply Input of current signal

6.2 Relay output

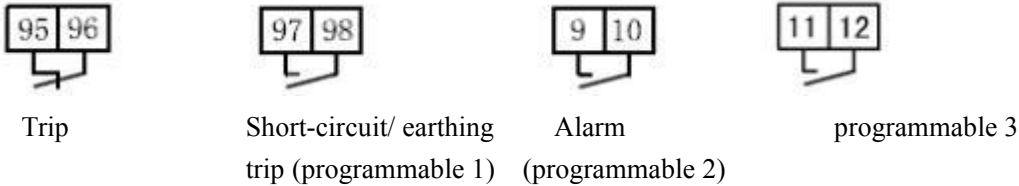

6.3 RS485 communication

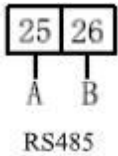

6.4 Analog output DC4-20mA

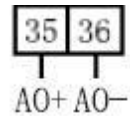

6.5 Switching input

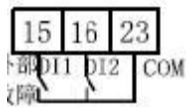

External fault

6.6 Input of zero-sequence current

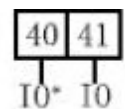

7. Communication protocol

7.1 Overview of communication protocol

The motor protector ARD2 series applies the communication protocol MODBUS-RTU. The MODBUS defines the check code, data sequence and others necessary for specific data exchange in details. By adopting the master-slave responder connection (half-duplex) in one communication line, it transmits signals in two opposite directions in one same communication line. The signal of master unit addresses the unique terminal unit (slave unit). Then the terminal unit sends the acknowledgment signal to the master unit in the opposite direction.

The MODBUS just allows the communication between the master unit (PC, PLC, etc.) and the terminal unit other than data exchange between independent terminal units. In this way, terminal units do not occupy the communication line upon initialization. They merely respond to the request signal received from the master unit.

7.1.1 Transmission mode

Adopt the asynchronous signal transmission in byte. The communication information between the master unit and the slave

unit is an 11-bit format including one start bit, eight data bits (send the minimum significant bit first), non-parity check bit and one stop bit.

7.1.2 Format of information frame

Address code	Function code	Data field	CRC check code
1 byte	1 byte	n bytes	2 bytes

Address code. It is in the front of frame and consists of one byte (8-bit binary code). The decimal system ranges from 0 to 255. The protector just uses the range from 1 to 247 and others are reserved. These bits identify the address of the terminal unit that user designates to receive the data from connected master unit. The address of each terminal unit is exclusive. Except for addressed terminal unit, no terminal unit will respond to the request including the address. When a terminal unit sends back a response, the response address data enables the master unit to identify the terminal unit communicating with it.

Function code. The function code identifies the function being executed by the addressed terminal unit. The following table lists function codes of this series, their meanings and functions.

Function	Definition	Operation
03H/04H	Read the data register	Obtain the current binary value of one or more registers
10H	Preset multiple registers	Set the binary value in multiple registers
06H	Preset the single register	Set the binary value in the single register

Data field. It contains data that the terminal unit requires for specific function or data acquired when the terminal unit responds to the request. These data may be the numerical value, the reference address or setting. For example, the function code identifies a register and the data field must identify the first register and number of data read out. The embedded address and data vary with the type and slave unit.

CRC check code. The error-checking (CRC) field occupies two bytes including one 16-bit binary value. CRC value is calculated in the transmission unit and attached to the data frame. The receiving unit will re-calculate the CRC value upon receipt and compare the calculated CRC value with that in the CRC field. An error is recognized if two values are different.

A CRC is generated in the following process:

1. Preset 0FFFFH in a 16-bit register (all in 1) and identify such register as CRC register.
2. Perform the XOR operation for 8 bits in the first byte of data frame and low byte in the CRC register and save the result in the CRC register.
3. Shift the CRC register one bit to the right, fill 0 in the most significant bit, move the least significant bit out and conduct the test.
4. If the least significant bit is 0, repeat the step 3 (next shift). If the least significant bit is 1, perform the XOR operation for the register and a presetting (0A001H).
5. Repeat the step 3 and step 4 eight times until eight bits are processed completely.
6. Repeat the step 2 to 5 to process the next eight bits until all bytes are processed.
7. The final value in the CRC register is the CRC value.

Alternatively, calculate the CRC with a preset table. The alternative method features the fast calculation. However, it requires a large memory. For more details, please refer to relevant data.

7.2 Brief description of function code

7.2.1 Function code 03H or 04H: read the register

It enables the user to obtain the data and system parameters acquired and recorded by unit. Though there is no restriction on the number of data requested by master unit, the number of data cannot exceed the defined address range.

In the following example, the slave unit 01 reads basic data L1, L2 and L3 acquired (each address occupies two bytes in the data frame). The addresses of L1, L2 and L3 are 0000H, 0001H and 0002H respectively.

Information sent by the master unit		Code
Address code		01H
Function code		03H
Start address	High byte	00H
	Low byte	00H
Number of registers	High byte	00H
	Low byte	03H
CRC check code	Low byte	CBH
	High byte	05H

Information sent by the slave unit		Code
Address code		01H
Function code		03H
Number of bytes		06H
Data in the register	High byte	00H
	Low byte	00H
Data in the register	High byte	00H
	Low byte	00H
Data in the register	High byte	00H
	Low byte	00H
CRC check code	Low byte	75H
	High byte	21H

7.2.2 Function code 10H: preset the register

The code allows user to change the data in multiple registers. With the code, user can preset the system parameter, output state of relay and other data in the protector. The master unit permits the presetting of eight data (16 bytes) once at most.

In the following example, the switch output DO3 is preset for the instrument at the address 01. The switch input/output state indicates that the address of register is 0003H, bits 0 and 1 correspond to DI1 and DI2 and bits 8 to 11 correspond to DO1 to DO4.

Information sent by the master unit		Code
Address code		01H
Function code		10H
Start address	High byte	00H
	Low byte	03H
Number of registers	High byte	00H
	Low byte	01H
Number of bytes		02H
Data to be preset in 0003H	High byte	04H
	Low byte	00H
CRC check code	Low byte	A3H
	High byte	A4H

Information sent by the slave unit		Code
Address code		01H
Function code		10H

Start address	High byte	00H
	Low byte	03H
Number of registers	High byte	00H
	Low byte	01H
CRC check code	Low byte	C9H
	High byte	F1H

7.2.3 Function code 06H: preset the single register

The function code 06H allows the user to change the information in the single register. Preset the system parameters, switch output state and others relating to the system with 06H.

In the following example, the switch output DO3 is preset for the instrument at the address 01. The switch input/output state indicates that the address of register is 0003H, bits 0 and 1 correspond to DI1 and DI2 and bits 8 to 11 correspond to DO1 to DO4.

Information sent by the master unit		Code
Address code		01H
Function code		06H
Start address	High byte	00H
	Low byte	03H
Data to be preset 0003H	High byte	04H
	Low byte	00H
CRC check code	Low byte	0AH
	High byte	7BH

Information sent by the slave unit		Code
Address code		01H
Function code		06H
Start address	High byte	00H
	Low byte	03H
Data to be preset 0003H	High byte	04H
	Low byte	00H
CRC check code	Low byte	0AH
	High byte	7BH

7.3 Address parameter

Table 9

Address	Address	Parameter	Property (R/W)	Range of value	Type
1	0x00	Actual current of phase L1	R	0-65535	word
		Fundamental current of phase L1	R	0-65535	word
2	0x01	Actual current of phase L2	R	0-65535	word
		Fundamental current of phase L2	R	0-65535	word
3	0x02	Actual current of phase L3	R	0-65535	word
		Fundamental current of phase L3	R	0-65535	word
4	0x03	Switch output	R/W	Bits 0 to 3 correspond to relays DO1 to DO4	High byte
		Switch input	R	Bits 0 and 1 correspond to the switch input DI1 and DI2	Low byte

5	0x04	Hold	R	0	word
6	0x05	Current unbalance	R	0-100%	word
7	0x06	Accumulative percentage of thermal capacity	R	0-100%	word
8	0x07	Phase failure trip delay	R/W	0.1-600.0	word
9	0x08	Current specification	R	0-1. 6,1-6.3、2-25、3-100, 4-250, 5-800, 6-1, 7-5	word
		Current scaling factor	R	10, 100	
10	0x09	Average current	R	0-65535	word
		Average fundamental current	R	0-65535	word
11	0x0A	Leakage current	R	30~1000mA	word
		Percentage of earthing current		1-100%	
12	0x0B	State of motor	R	Residual overload cooling time	High byte
				Bit 0: hold; Bit 1: stop; Bit 2: start; Bit 3: run; Bit 4: alarm; Bit 5: trip	Low byte
13	0x0C	Indication of trip fault	R	Bit 0: overload trip; Bit 1: earthing/leakage trip; Bit 2: under-load trip; Bit 3: phase failure trip; Bit 7: blocking trip; Bit 8: unbalance trip; Bit 10: external fault trip; Bit 11: start time-out trip; Bit 15: short circuit trip	word
14	0x0D	Overload/ full-load current	R/W	0.4-800.0	word
15	0x0E	Trip level	R/W	1、 2、 3、 5、 10、 15、 20、 25、 30、 35、 40	word
16	0x0F	Starting time	R/W	0.1-999.9	word
17	0x10	Overload alarm threshold	R/W	1-99%	word
18	0x11	Hold	R		word
19	0x12	Leakage current	R/W	30-1000mA	word
		Earthing trip percentage	R/W	20-100%	word
20	0x13	Earthing/leakage trip delay	R/W	0.1-600.0	word
21	0x14	Enabling of residual current transformer	R/W	0: disabled;1:enabled	word
22	0x15	Under-load threshold	R/W	10-99%	word
23	0x16	Under-load trip delay	R/W	0.1-600.0	word
24	0x17	Hold	R	0	word
25	0x18	Unbalance threshold	R/W	10-80%	word
26	0x19	Unbalance trip delay	R/W	0.1-600.0	word
27	0x1 A	Unbalance alarm threshold	R/W	10-80%	word
28	0x1B	Alarm enabling on/off	R/W	Bit 0: overload alarm Bit 8: unbalance alarm	word
29	0x1C	Trip enabling on/off	R/W	Bit 0: overload trip; Bit 1: earthing/leakage trip; Bit 2: under-load trip; Bit 3: phase failure trip; Bit 6: locked-rotor trip; Bit 7: blocking trip;	word

				Bit 8: unbalance trip; Bit 10: external fault trip; Bit 11: start time-out trip; Bit 15: short circuit trip		
30	0x1D	System frequency	R	50、60	word	
31	0x1E	MODBUS baud rate: 2400, 4800, 9600, 19200, 38400	R/W	2400、4800、9600、19200、38400	word	
32	0x1F	MODBUS address	R/W	1-247	word	
33	0x20	CT transformation ratio	R/W	1-2000	word	
34	0x21	Fundamental wave on/off	R/W	0: effective value; 1: fundamental wave	High byte	
		Hold type of motor	R/W	0: single-phase; 1: 3-phase 4-wire	Low byte	
35	0x22	Short circuit threshold	R/W	400%-700%, max. measurable overload multiple	word	
36	0x23	Short-circuit trip delay	R/W	0.1-600.0	word	
37	0x24	Blocking value	R/W	100-700	word	
38	0x25	Blocking trip delay	R/W	0.1-600.0	word	
39	0x26	Remote reset	R/W	0: normal; 1: remote reset	word	
40	0x27	External fault trip delay	R/W	0.1-600.0	word	
41	0x28	Programmable 1 relay setting	R/W	1. alarm; 2. trip; 3. overload; 4. short circuit; 5. earthing/ leakage trip; 6. phase failure; 7. external fault; 8. remote start; 9. leakage alarm; 10. short-circuit and earthing protection; 11. short circuit, earthing/ leakage; 12. short circuit, earthing/ leakage (pulse 1s)	word	
42	0x29	Overload cooling time	R/W	0: manual reset; automatic reset: 1-30min	word	
43	0x2A	Programmable 2 relay setting	R/W	Same as the relay setting of programmable 1	word	
44	0x2B	Programmable 3 relay setting	R/W	Same as the relay setting of programmable 1	word	
45	0x2C	Initial relay state	R/W	0: open; 1: closed; bits 0 to 3: relays 1 to 4	word	
46	0x2D	Locked-rotor trip threshold	R/W		word	
47	0x2E	Locked-rotor trip delay	R/W		word	
48	0x2F	Event control parameter	R		word	
49	Event record 1	0x30	STA1	R	Actuation of protection 1 1: overload trip; 2: earthing/leakage trip; 3: under-load trip; 4: phase failure trip; 7:locked-rotor trip; 8: blocking trip; 9: imbalance trip; 11: external fault trip; 12: start time-out trip; 16: short-circuit trip	High byte
			Month 1	R	Actuation month of protection 1	Low byte

50		0x31	Day 1	R	Actuation day of protection 1	High byte	
			Hour 1	R	Actuation hour of protection 1	Low byte	
51		0x32	Minute 1	R	Actuation minute of protection 1	High byte	
			Second 1	R	Actuation second of protection 1	Low byte	
52	Event record 2	0x33	STA2	R	actuation of protection 2	High byte	
			Month2	R	Actuation month of protection 2	Low byte	
53		0x34	Day2	R	Actuation day of protection 2	High byte	
			Hour2	R	Actuation hour of protection 2	Low byte	
54		0x35	Minute2	R	Actuation minute of protection 2	High byte	
			Second2	R	Actuation second of protection 2	Low byte	
55		Event record 3	0x36	STA3	R	actuation of protection 3	High byte
				Month3	R	Actuation month of protection 3	Low byte
56	0x37		Day3	R	Actuation day of protection 3	High byte	
			Hour3	R	Actuation hour of protection 3	Low byte	
57		0x38	Minute3	R	Actuation minute of protection 3	High byte	
			Second3	R	Actuation second of protection 3	Low byte	
58		Event record 4	0x39	STA4	R	actuation of protection 4	High byte
				Month4	R	Actuation month of protection 4	Low byte
59	0x3A		Day4	R	Actuation day of protection 4	High byte	
			Hour4	R	Actuation hour of protection 4	Low byte	
60		0x3B	Minute4	R	Actuation minute of protection 4	High byte	
			Second4	R	Actuation second of protection 4	Low byte	
61		Event record 5	0x3C	STA5	R	actuation of protection 5	High byte
				Month5	R	Actuation month of protection	Low byte
62	0x3D		Day5	R	Actuation day of protection 5	High byte	
			Hour5	R	Actuation hour of protection 5	Low byte	
63		0x3E	Minute5	R	Actuation minute of protection 5	High byte	
			Second5	R	Actuation second of protection 5	Low byte	
64		Event record 6	0x3F	STA6	R	actuation of protection 6	High byte
				Month6	R	Actuation month of protection 6	Low byte
65	0x40		Day6	R	Actuation day of protection 6	High byte	
			Hour6	R	Actuation hour of protection 6	Low byte	
66		0x41	Minute6	R	Actuation minute of protection 6	High byte	
			Second6	R	Actuation second of protection 6	Low byte	
67		Event record 7	0x42	STA7	R	actuation of protection 7	High byte
				Month7	R	Actuation month of protection 7	Low byte
68	0x43		Day7	R	Actuation day of protection 7	High byte	
			Hour7	R	Actuation hour of protection 7	Low byte	
69		0x44	Minute7	R	Actuation minute of protection 7	High byte	
			Second7	R	Actuation second of protection 7	Low byte	
70		Event record 8	0x45	STA8	R	actuation of protection 8	High byte
				Month8	R	Actuation month of protection 8	Low byte
71	0x46		Day8	R	Actuation day of protection 8	High byte	
			Hour8	R	Actuation hour of protection 8	Low byte	
72		0x47	Minute8	R	Actuation minute of protection 8	High byte	

		Second8	R	Actuation second of protection 8	Low byte
73	0x48	Hold	R/W		word
74	0x49	Version of software	R	0.1 ~100.0	word
75	0x4A	Year	R/W	2012-2099	
76	0x4B	Month	R/W	1-12	
77	0x4C	Day	R/W	1-31	
78	0x4D	Hour	R/W	0-24	
79	0x4E	Minute	R/W	0-59	
80	0x4F	Second	R/W	0-59	
81	0x50	Running time of current cycle	R	0-65535 hour	word
82	0x51	Stopping time of current cycle	R	0-65535 hour	word
83	0x52	Total running time	R/W	0-65535 hour	word
84	0x53	Total stopping time	R/W	0-65535 hour	word
85	0x54	Total number of starts	R/W	0-65535	word
86	0x55	Total number of trips	R/W	0-65535	word

8. Typical application solutions

Direct start mode. The local button controls the start and stop of motor in the drawing. The protector cannot start or stop the motor independently. The sucking coil of contactor KM is engaged in the NC contact of trip relay. When the electricity is supplied and the start button SF is pressed, the sucking coil of KM is energized to close the main contact of KM and activate the motor. If the stop button SS is pressed, the sucking coil of KM is de-energized to release the main contact of KM and deactivate the motor.

Note: The remote start is controlled by the host computer rather than protector.

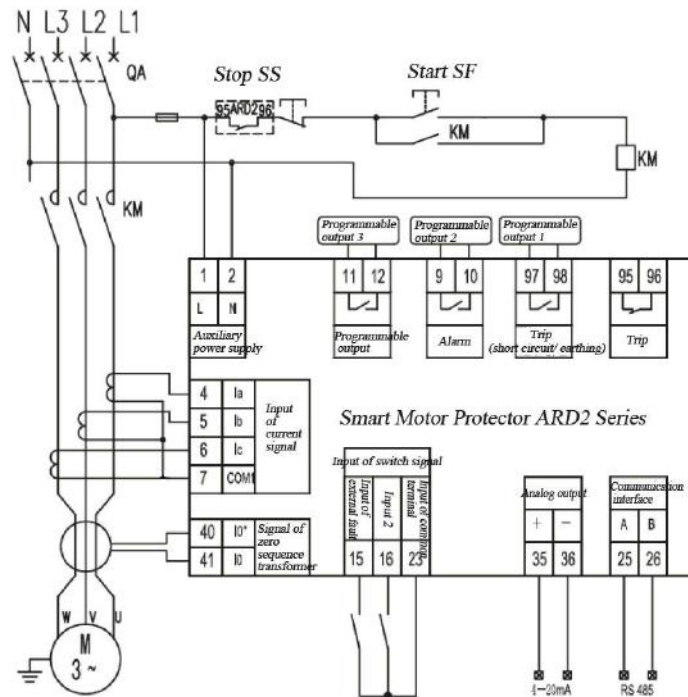

Direct Start Wiring of Motor Protector ARD2

Y-Δ start mode. The local button controls the start and stop of motor in the drawing. The protector cannot start or stop the motor independently. The sucking coil of contactor KM1 is engaged in the NC contact of trip relay. When the electricity is

supplied and the start button SF is pressed, the sucking coils of KM1 and KM3 are energized to close the main contacts of KM1 and KM3 and activate the motor in the Y mode. When the delay time is reached, the time relay KT is enabled. The sucking coil of KM3 is de-energized and the main contact of KM3 is open while the sucking coil of KM2 is energized and the main contact of KM2 is closed. The motor starts in the normal Δ mode. If the stop button SS is pressed, the sucking coil of KM1 is de-energized to release the main contact of KM1 and deactivate the motor.

Note: The remote start is controlled by the host computer rather than protector.

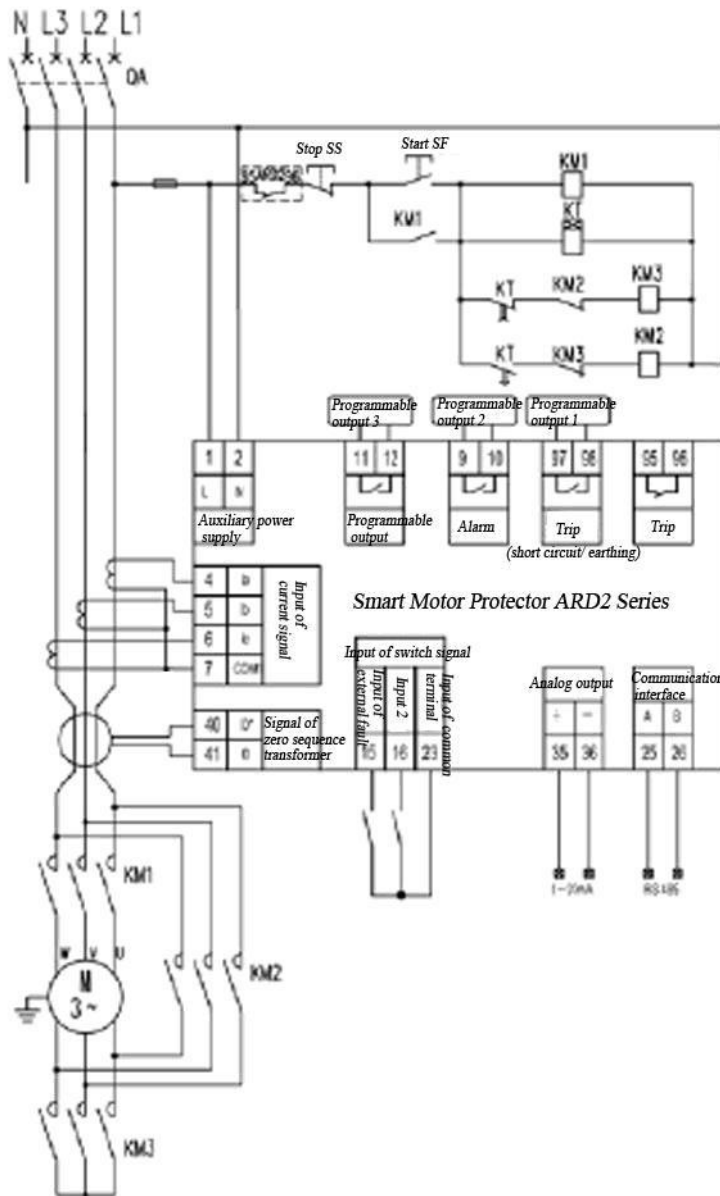

Y- Δ Start Wiring of Motor Protector ARD2

9. Setting and instructions of protection functions

9.1 Setting of protective parameters Table 10

Function	Item	Content
Start time-out protection	Range of starting time	0.1s-999.9s
	Actuation time	Instant
	Actuation method	trip
Overload protection	Non-operating characteristic	<105% I _e , no operation in 2h
	Operating characteristic	>120%I _e , delay in 1h
	Trip level	1,2,3,5,10,15,20,25,30,35,40
	Alarm threshold	1%-99%
	Overload protection method	Alarm& trip
Locked-rotor protection	Setting range of operating value	(100%-700%) I _e
	Setting range of delay time	0.1s-600.0s, graduation in 0.1 s
	Actuation method	Trip
Blocking protection	Setting range of operating value	100%-700% I _e
	Setting range of delay time	0.1s-600.0s, graduation in 0.1 s
	Actuation method	Trip
Under-load protection	Setting range of operating value	(10%-99%) I _e
	Setting range of delay time	0.1s-600.0s, graduation in 0.1 s
	Actuation method	Alarm& trip
Unbalance protection	Setting range of operating value	10%-80%
	Actuation time	0.1s-600.0s, graduation in 0.1 s
	Actuation method	Trip
Earthing/leakage protection	Setting range	30-1000mA
	Delay time	0.1s-600.0s, graduation in 0.1 s
	Actuation method	Trip
Short-circuit protection	Short-circuit setting	(400%-700%) I _e
	Actuation time	0.1s-600.0s, graduation in 0.1 s
	Actuation method	Trip
External fault protection	Actuation time	0.1s-600.0s, graduation in 0.1 s
	Actuation method	Trip
Phase failure protection	Actuation time	0.1s-600.0s, graduation in 0.1 s
	Actuation method	Trip

9.2 Description of protective functions

Enabling time of protective functions: Table 11

Type of protection	Working periods
External fault	Stop
External fault, phase failure, leakage/ earthing, locked-rotor and start time-out	Start
External fault, phase failure, leakage/ earthing, overload, unbalance, blocking, under-load, short circuit	Running

■ Starting overtime protection

When the starting time reaches the setting value and the average current of phases exceeds 1.1 times (1.7 for Ex motor) than the rated current, the protection is activated according to the setting and a trip command is sent to stop the motor.

■ Overload protection

When the motor runs under overload conditions (actual current above the rated value) for a long time, the overheating will

occur and the insulation will be reduced and burnt. The protector calculates the thermal capacity of motor according to the heating characteristic and then protects the motor by simulating the heating characteristic.

Refer to the table 9 for relationship between the overload current and the time. The following diagram illustrates the overload characteristic curve (curve K).

Relationship between the overload current and time Table 12

Selectable trip curve level, K	1	2	3	5	10	15	20	25	30	35	40
Trip delay error, s, ±10%	Balanced three-phase load, starting from the cold state										
Rated value $I_e * 1.2$	25	50	75	125	250	375	500	625	750	875	1000
x1.5	16	32	48	80	160	240	320	400	480	560	640
x2	9	18	27	45	90	135	180	225	270	315	360
x3	4	8	12	20	40	60	80	100	120	140	160
x4	2.26	4.52	6.78	11.3	22.5	33.8	45	56.3	67.5	78.8	90
x5	1.44	2.88	4.32	7.2	14.4	21.6	28.8	36	43.2	50.4	57.6
x6	1	2	3	5	10	15	20	25	30	35	40
x7.2	0.7	1.4	2.1	3.5	6.9	10.4	13.9	17.4	20.8	24.3	27.8

When the protector detects the overload running of motor, it shall send the alarm or trip signal within the alarm or trip (delay) setting time.

Overload characteristic curve (curve K)

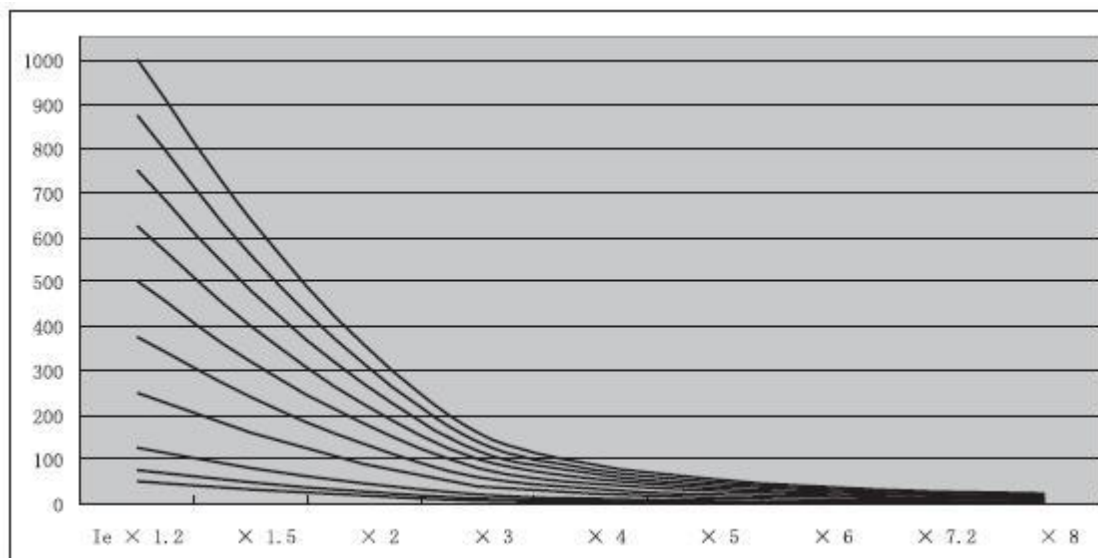

■ Locked-rotor protection (over-current protection upon start)

If the motor shaft is caught due to the great load or mechanical troubles upon start or during running and the problem is not resolved promptly, the overheating will occur and the insulation will be reduced and burnt. The locked-rotor protection is available when the motor shaft is caught upon start. The blocking protection is available when the motor shaft is caught during running. After the current reaches the actuation setting, the protector performs the trip within the trip (delay) time setting to prevent the motor from burning.

■ Under-load protection

The no-load or under-load operation of motor is hazardous for connected pump load, if any. In such case, the protector provides the under-load protection. When the ratio of average current of phases to rated current is lower than the setting, the protector performs the trip within the trip (delay) time setting.

■ Unbalance protection

When the motor is running and the three-phase unbalance rate reaches the setting, the protector provides the protection by sending the alarm or trip signal. It increases the running safety of motor.

Maximum difference between three-phase current and average current/maximum difference between rated current and average current

■ Earthing/ leakage protection

The protector is provided with the earthing protection and leakage protection (user can just select one protective function). The earthing current is the vector sum of three-phase current. When the zero sequence transformer detects that the leakage current is above the setting, the protector trips within the trip (delay) setting time for human safety.

■ Short-circuit protection

When the running current of motor exceeds the current setting, the protector provides the protection and trips within the trip (delay) setting time.

■ External fault protection

When any external fault occurs, the external fault switching value is closed. Then the protector detects the input of external fault signal and trips within the trip (delay) setting time.

■ Phase failure protection

The phase failure operation is hazardous for motor. In case of phase failure, the protector provides the protection and sends the trip command to guarantee the running safety of motor.

Note: The analog output 20mA (4—20mA) corresponds to the current two times than the rated current (P001).

10. Cautions

1. To improve the anti-interference capacity, the protector ARD2L may select the fundamental current for display and protection. Select the true RMS or fundamental mode with the fundamental switch option in the menu of system parameter.
2. The direction of primary circuit must be identical to that of three-phase current. Otherwise, the earthing protection may fail.
3. If the protector is provided with the earthing/leakage protection, recommend the shielded conductor to lead the zero sequence current transformer into the protector. Otherwise, the measured data may be inaccurate.
4. Set the rated current of protector (P001) properly. If the setting is below the normal rated current of motor, the motor may not start normally. If the setting is above the normal rated current of motor, the protector may not provide the normal protection for failed motor.
5. After the protector trips, resolve the fault and reset the protector before restarting the motor. Otherwise, the motor cannot start.
6. Cooling time of motor: 30min. After the overload protection is enabled (fault code: hEAt), cool the motor and then reset it because of heat accumulation.
7. It is necessary to reset the protector after changing any parameter. Then the current setting becomes valid.
8. If the protector is enabled as soon as the motor starts or is always disabled because the parameter setting of protector is improper for the intended application, turn off all protective functions. Then reset the protector according to parameters measured during normal running of motor.
9. If the protector is enabled as soon as the motor starts and protective parameter settings are proven suitable, find out causes according to the displayed code.
10. The setting of protector is default when the protector is delivered (unless otherwise specified by user). User can turn on all protective functions and set them to actual demands.
11. Unless otherwise specified the length of connecting line is 1m between the transformer and protector.
12. User must specify the special requirements (e.g. single-phase motor protector and length of connecting line) in the order.

11. Order sample

Example: Model: ARD2-25/CLMKSR

Auxiliary power supply: AC220V

Display mode: nixie tube

Rated current of motor: 6.3-25A

Application: three-phase motor

Measurement: three-phase current and average current of phases

Additional functions: RS485 Modbus, zero sequence current measurement, DC analog output 4-20mA, 2-way switch input, 1-way relay output and 8 event records

1. Overview

Smart motor protectors ARD2F series (hereinafter referred to as the protector), utilizes advanced single-chip microcomputer technology which has many features like strong anti-interference, stable and reliable running, digitalization, intelligence and networking, etc. Protector can protect motors from many faults during the motor running such as timeout startup, overload, locked rotor/block, phase failure, unbalance, under-load, earthing, earth leakage, over voltage, under voltage, phase sequence, overpower, under power, temperature, external faults, etc. and is equipped with SOE fault event log function which is convenient for maintenance staff to find the causes of the problems, and display the running state clearly and intuitively through LCD in Chinese in four lines, status indicators and other ways. It is suitable for coal mine, petrochemical industry, metallurgy industry, power industry, shipbuilding, civil buildings and other fields. The protector has RS485 remote communication interface and DC4-20mA analog output, which is convenient to form a network system together with control machines like PLC and PC to realize the remote monitoring of motor.

2. Product type

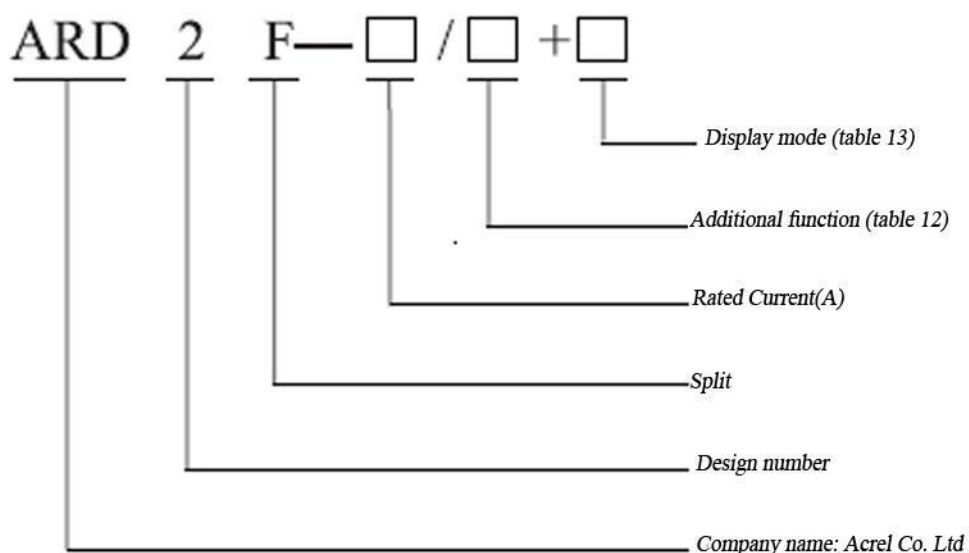

Table 13

Additional function		Code	Additional function	Code
Starting control (including K function)		Q	Leakage protection	L.
Switching input		K	4-20 mA analog output	M
Temperature protection		T	Loss voltage restart (anti sway electric)	SU
Alarm (Programmable output)		J	SOE event record	SR
Communication interface	Modbus-RTU	C	Voltage function (phase sequence, power, power factor)	U
	Profibus-DP	CP		
	DeviceNet	CD		
t _E time protection		t _E		

Note: 1. When equipped with starting control, the protector provides no more than 2 starting relay for the sequence control of the closing/opening of two external contactors to realize different starting ways of motor (such as Y-Δ transformation starting, positive and negative rotation control, and self-coupling reduced-voltage starting, etc.)

2. The measurement range of temperature protection: thermal resistance 100Ω, -30KΩ,;
3. For the customer with no display requirements, a 90L display unit must be ordered together in a batch of orders for commissioning.

Table 14

Code	Specification
90L	The size of LCD liquid display module is 90*70, hole of 86*66 (unit: mm)

3 General technical index

Table 15

Technical parameters	Technical specification	
Auxiliary power supply of protector	AC85V~220VDCI00~350V, power consumption 15VA	
Rated working voltage of motor	AC380V/AC660V, 50Hz/60Hz	
Rated working current of motor	1A(O.1A-9999A)	Small special current transformers
	5A(O.1A-9999A)	
	1.6A(OAA-1.6A)	
	6.3A(1.6A-6.3A)	
	25A (6.3A-25A)	
	100A (25A-100A)	
	250A (63A-250A)	Special current transformers
	800A (250A-800A)	
Relay output contactor, rated negative capacity	5, AC250V、6A	
Switching input	9, opto-coupler insulation	
Telecommunication	RS485 Modbus RTU、Profibus DP protocol	
Environment	Working Temperature	-10°C~55°C
	Storage temperature:	-20°C-18mm
	Relative humidity	5%~95% no condensation
	Altitude	≤200m
Classes of pollution	Level 2	
Protection level	Main part IP20, display unit IGIP45	
Installation category	Class III	

4 Overall dimensions and installation (unit: mm)

4.1 Appearance and size of mounting hole

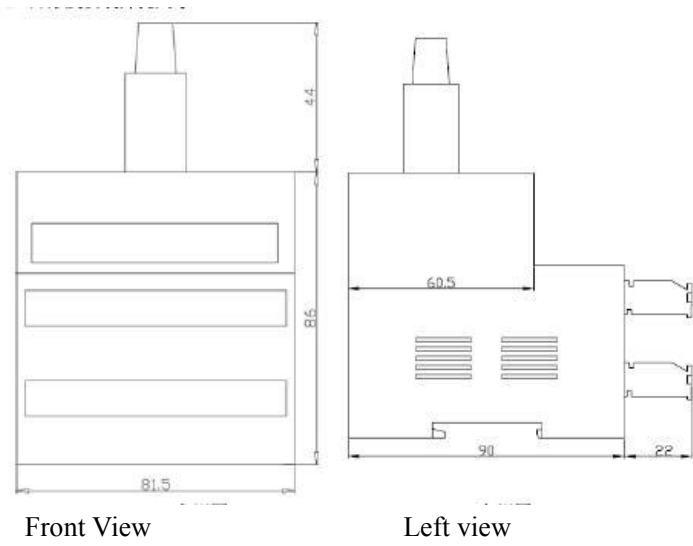

Front View

Left view

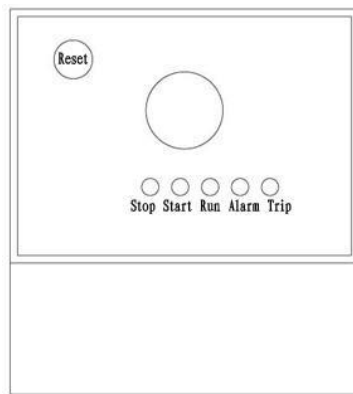

Top view

4.2 Installation dimension of protector display unit

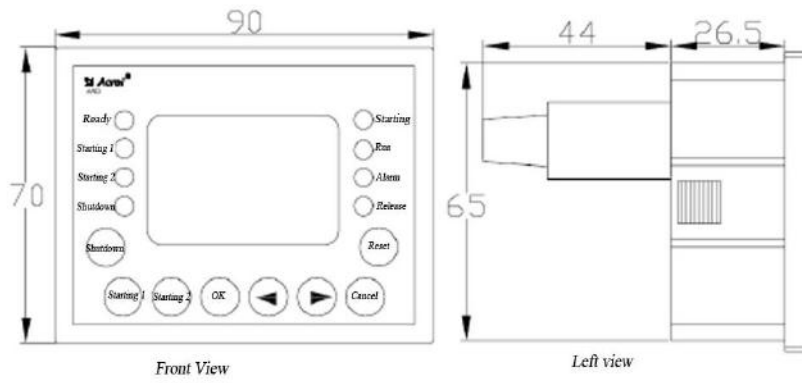

Front View

Left view

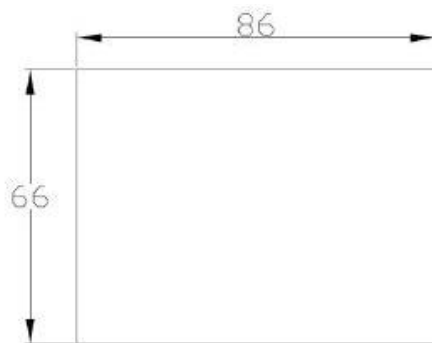

Panel opening

4.3 Installation dimensions of transformer

See the ARD2 Transformer Installation Dimension

4.4 Anti sway electric module

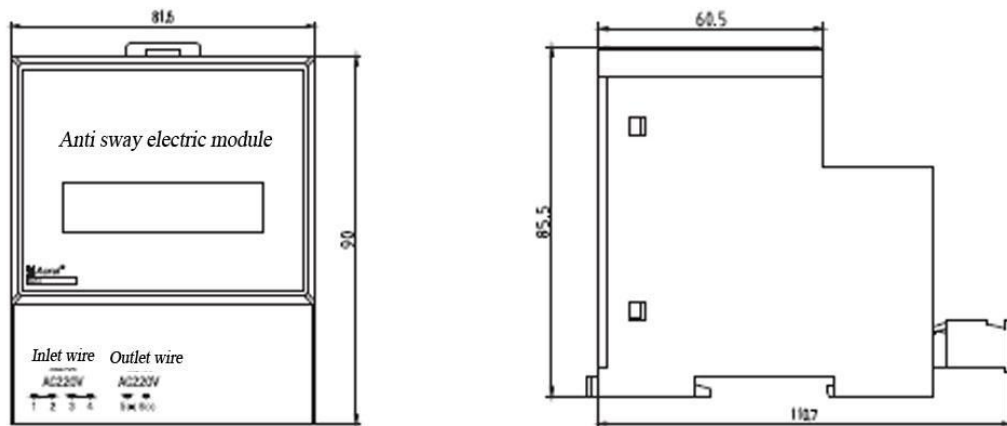

4.5 AC380 power module

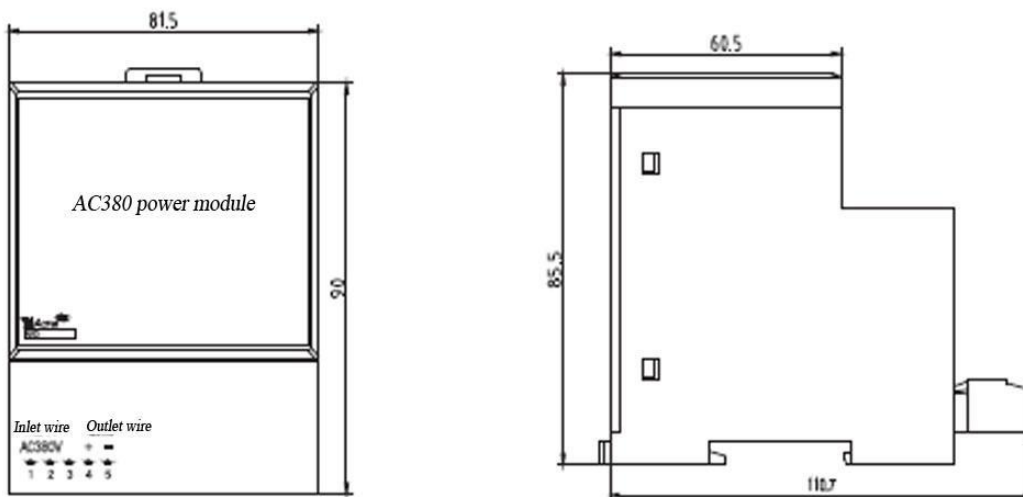

5 Display and Parameters Setting

5.1 Operation Panel Instruction

Users can observe the running status of motor through the LED indicating lamp and Chinese LCD on display unit and start, stop, reset and set parameters through the buttons.

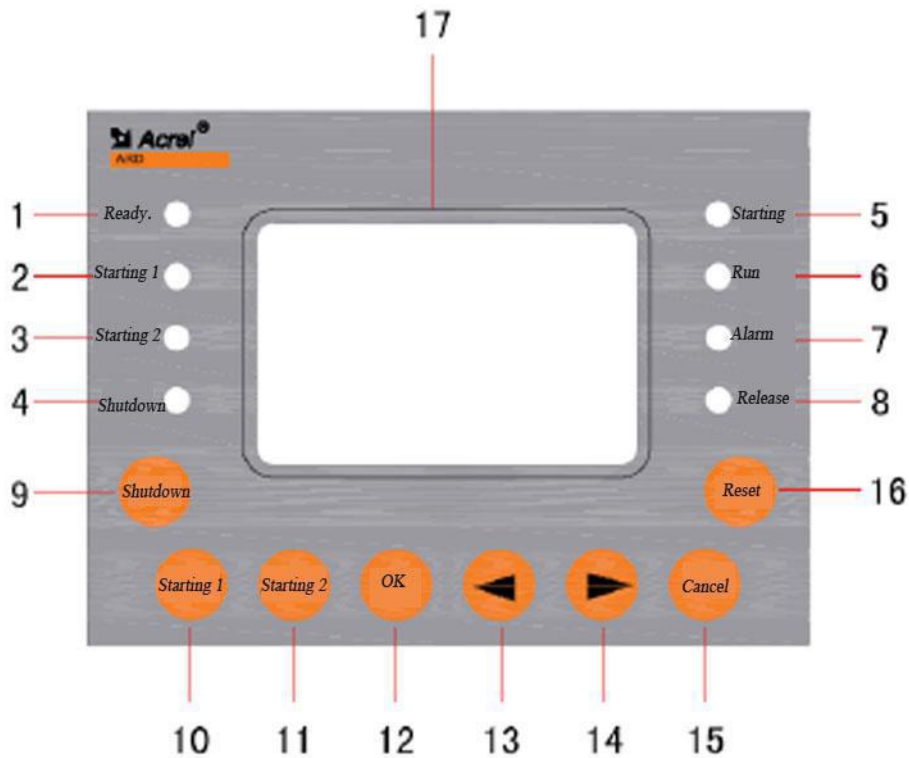



Table 16

No.	Name	Status	Function Description
1	Ready LED	On	When it is on, it indicates that the protector is in normal state and the motor can be started.
2	Starting 1 LED	On	When it is on, it indicates that the protector starting 1 relay closed
3	Starting 2 LED	On	When it is on, it indicates that the protector starting 2 relay closed
4	Stopping LED	On	When it is on, it indicates that the motor is in stopping status.
5	Starting LED	On	When it is on, it indicates that the motor is in starting status.
6	Running LED	On	When it is on, it indicates that the motor is in running status.
7	Alarm LED	On	When it is on, it indicates that the protector alarm relay has taken action.
8	Trip LED	On	When it is on, it indicates that the protector trip relay has taken action.
9	Stop button	Hold down	Trip starting 1, starting 2 relays
10	Starting 1 button	Hold down	Operate starting 1 relay to make it closed
11	Starting 2 button	Hold down	Operate starting 2 relay to make it closed
12	Confirm button	Hold down	Enter the menu and modify the parameters









13	 arrow key	Hold down	Turn on the menu; data transfer; view event log
14	 arrow key	Hold down	Turn down menu; modify data;
15	cancel button	Hold down	Exit the menu; cancel operation; lighten backlight
16	reset button	Press	Reset the protector
17	LCD display screen		Display various measured parameters and setting parameters

5.2 Parameter setting -

5.2.1 Display menu contents z

1. A, B, C three-phase current and unbalance percentage
2. Three-phase current and the percentage of three-phase average current to the set rated current
3. Uab, Ubc, Uca line voltage
4. Active power P, apparent power S, power factor PF;
5. Iav three-phase average current, Uav three-phase average voltage, Id earth leakage current, frequency F;
6. Heat capacity percentage
7. Thermal resistance value:
- 8 Route 5 relay input: 1-Starting 1, 2-Starting, 2, 3-Alarm (programmable)
4- Trip (Programmable), 5- Trip
9. Route 9 DI status.

Users can press the “” button on the display unit to display the selection of menu interface.

If users want to enter parameter setting menu, they can press the “Confirm” button when displaying the menu interface and then password input interface comes out, and users can enter the parameter setting menu after inputting the password (initial password is 0001, universal password is 0008), and users can press “” and “” button to input the correct password and then press “Confirm” button to enter parameter setting menu; and at this moment users can press “” and “” buttons to select the needed items and then press “Confirm” button to enter the setting interface and again press “” and “” buttons to select the needed sub-items, press “Confirm” key to enter the value setting interface, and then press “” and “” to set the value, after finishing setting, press “Confirm” key for save, after that, press “Cancel” button to exit or press “Cancel” button to exit without saving.

6Wiring Mode

6.1Auxiliary power

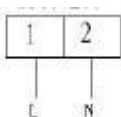

Auxiliary power

6.2 Voltage, current, zero sequence current signal input

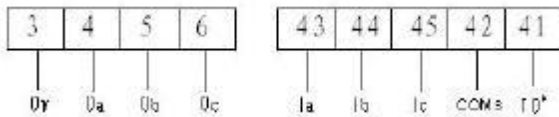

Voltage signal input Current signal input Zero sequence current input

6.3 Relay input

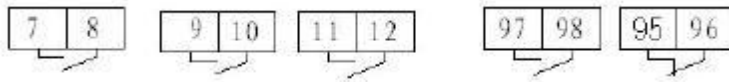

Starting 1 Starting 2 Alarm (DO3 programmable) Trip (DO4 programmable) Trip

6.4 RS485 communication, DC4-20mA analog output, thermal resistance input

RS485

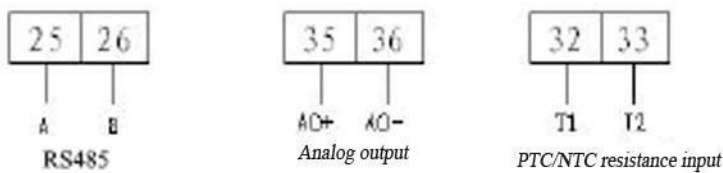

6.5) Switching input:

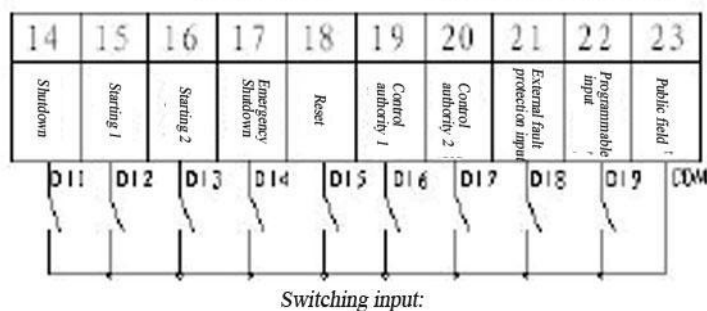

7 Communication protocol

7.1 Communication protocol overview

See ARD2 Communication Protocol Overview

7.2 Address parameter

Address	Address	Parameters	Read-write property	Value range	Type
1	0x00	L1 phase actual current	R.	0-65535	Word
		L1 phase fundamental wave current	R.	0-65535	Word
2	0x01	L2 phase actual current	R.	0-65535	Word
			R.	0-65535	Word
		L2 phase fundamental wave current	R.	0-65535	Word
3	0x02	L3 phase actual current	R.	0-65535	Word

		L3 phase fundamental wave current	R.	0-65535	Word
4	0x03	Earth leakage current	R.	30-100mA	Word
		Earthing current percentage	R.	1-100%	Word
5	0x04	Uab line-voltage	R.	0-999.9	Word
6	0x05	Ubc line-voltage	R.	0-999.9	Word
7	0x06	Uca line-voltage	R.	0-999.9	Word
8	0x07	Apparent power	R.	0-65535	High byte
9	0x08		R.	0-65535	Low byte
10	0x09	Active power	R.	0-65535	High byte
11	0x0A		R.	0-65535	Low byte
12	0x0B	Hold	R/W		High byte
13	0x0C		R/W		Low byte
14	0x0D	Power factor	R.	0-1 unit 0.001	Word
15	0x0E	Unbalance degree of current	R.	0-100%	Word
16	0x0F	Accumulated thermal capacity percentage	R.	0-100%	Word
17	0x10	Temperature value	R.	100-30000	Word
18	0x11	Motor running time of this time	R.	0-65535 hours	Word
19	0x12	Motor stopping time of this time	R.	0-65535 hours	Word
20	0x13	Switching output	R/W	Bit0-bit8 corresponding Switching input DI1-DI9, Bit11 relay1, Bit12 relay2, Bit13 relay3, Bit14 relay4, Bit15 relay5	Word
21	0x14	Trip fault indicator	R.	Bit 0 overload trip Bit1 earthing/earth leakage trip Bit2 under load trip Bit3 phase failure trip Bit4 under voltage trip Bit5 over voltage trip Bit6 locked-rotor trip Bit7 block trip Bit8 imbalance trip Bit9 PTC temperature trip Bit10 external fault trip Bit11 starting overtime trip Bit12 over power trip Bit13 under power trip Bit14 phase sequence trip Bit15 short circuit trip	Word
22	0x15	Hold	R/W		Word

23	0x16	Alarm fault indicator	R.	Bit 0 overload alarm Bit1 earthing/earth leakage alarm Bit2 under load alarm Bit3 phase failure alarm Bit4 under voltage alarm Bit 5over voltage alarm Bit6 locked-rotor alarm Bit7 block alarm Bit8 unbalance alarm Bit9 PTC temperature alarm Bit10 external fault alarm Bit11 starting overtime alarm Bit12 over power alarm Bit13 under power alarm Bit14 phase sequence alarm Bit15 short circuit alarm	Word
24	0x17	Hold	R/W		Word
25	0x18	Current specifications:	R.	0-1.6、 1-6.3、 2-25、 3-100、 4-250、 5-800、 6-1、 7-5	Word
		Current scaling factor	R.	10、 100	
26	0x19	A phase overload percentage	R.		Word
27	0x1A	B phase overload percentage	R.		Word
28	0x1B	C phase overload percentage	R.		Word
29	0x1C	Overload percentage	R.		Word
30	0x1D	Frequency	R.	45.0-70.0	Word
31	0x1E	Motor status;	R.	Motor thermal overload cooling remaining time	Word
				Bit0 ready; Bit1 stop; Bit2 start Bit3 running; Bit4 alarm; Bit5 trip	
32	0x1F	Hold	R/W		Word
33	0x 20	Hold	R/W		Word
34	0x 21	Hold	R/W		Word
35	0x 22	Hold	R/W		Word
36	0x 23	Hold	R/W		Word
37	0x 24	Hold	R/W		Word
38	0x 25	Hold	R/W		Word
39	0x26	Hold	R/W		Word
40	0x27	Hold	R/W		Word
41	0x28	Hold	R/W		Word
42	0x29	Operational control position	R/W	1 stop, 2 start1, 3 start 2	Word
43	0x2A	Hold	R/W		Word
44	0x2B	Factory Reset	R/W	0xFFFF	Word

45	0x2C	Total operation time	R/W	0-65535 hours	Word
46	0x2D	Total stopping time	R/W	0-65535 hours	Word
47	0x2E	Total number of starts	R/W	0-65535	Word
48	0x2F	Total trip times	R/W	0-65535	Word
49	0x30	Year	R/W	2012-2099	Word
50	0x31	Month	R/W	1-12	Word
51	0x32	Day	R/W	1-31	
52	0x33	Hour	R/W	0-24	Word
53	0x34	Cent	R/W	0-59	Word
54	0x35	Second	R/W	0-59	Word
55-93	0x36-0x5C	Hold	R/W		Word
94	0x5D	high-speed switch	R/W	0 low speed 1 high speed	Word
95	0x5E	Transmission type set	R/W	0-Ia、1-Ib、2-Ic、3-Iav、4-Uab、 5-Ubc、6-Uca、7-Uav、8-PTC、9-thermal capacity、10-P、11-F	Word
		Transmission ratio set	R/W	1-8	
96	0x5F	Residual current transformer input symbol	R/W	0 not input 1 input	Word
97	0x60	Fundamental wave switch	R/W	1 fundamental wave value 0 valid value	Word
98	0x61	Motor Type	R/W	0 general motor 1 increased safety motor	Word
99	0x62	CT ratio	R/W	1-2000	Word
100	0x63	Rated frequency	R/W	45-70	Word
101	0x64	Rated current of motor	R/W	1.6-800.0	Word
102	0x65	Rated voltage of motor	R/W	190、380、690	Word
103	0x66	Rated power of motor	R/W	High level	Word
104	0x67		R/W	Low level	Word
105	0x68	Start time setting	R/W	0.1-999.9	Word
106	0x69	Connection Mode	R/W	0 single-phase mode 1 three-phase mode 1 three-phase mode	Word
107	0x6A	Trip level setting	R/W	1、2、3、5、10、15、20、25、 30、35、40	Word
		TE trip time setting	R/W	2、3、4、5、6、8、10、12、15	
108	0x6B	Overload automatic reset	R/W	1 open 0 closed	Word
		Overload cooling time		1-255min	
109	0x6C	Hold	R/W		Word

110	0x6D	Trip allowable bit open/closed	R/W	Bit 0 overload trip Bit1 earthing/earth leakage trip Bit2 under load trip Bit3 phase failure trip Bit4 under voltage trip Bit5 over voltage trip Bit6 Stall trip Bit7 block trip Bit8 imbalance trip Bit9 PTC temperature trip Bit10 external fault trip Bit11 starting overtime trip Bit12 over power trip Bit13 under power trip Bit14 phase sequence trip Bit15 short circuit trip	Word
111	0x6E	Hold	R/W		Word
112	0x6F	Hold	R/W		Word
113	0x70	Alarm allowable bit open/closed	R/W	Bit 0 overload alarm Bit1 earthing/earth leakage alarm Bit2 under load alarm Bit3 phase failure alarm Bit4 under voltage alarm Bit 5 over voltage alarm Bit6 locked-rotor alarm Bit7 block alarm Bit8 unbalance alarm Bit9 PTC temperature alarm Bit10 external fault alarm Bit11 starting overtime alarm Bit12 over power alarm Bit13 under power alarm Bit14 phase sequence alarm Bit15 short circuit	Word
114	0x71	Hold	R/W		Word
115	0x72	Hold	R/W		Word
116	0x73	Overload alarm threshold setting	R/W	1-99%	Word
117	0x74	Phase failure trip delay setting	R/W	0.1-600	Word
118	0x75	Earthing/earth leakage alarm current setting	R/W	100-1,000mA	Word
119	0x76	Earthing/earth leakage trip current setting	R/W	100-1,000mA	Word
120	0x77	Earthing/earth leakage trip delay setting	R/W	0.1-600	Word
121	0x78	Locked-rotor alarm threshold setting	R/W	100-700%	Word
122	0x79	Locked-rotor trick threshold setting	R/W	100-700%	Word
123	0x7A	Locked-rotor trick delay setting	R/W	0.1-600	Word
124	0x7B	Blocking alarm threshold setting	R/W	100-700%	Word
125	0x7C	Blocking trip threshold setting	R/W	100-700%	Word
126	0x7D	Blocking trip delay setting	R/W	0.1-600	Word
127	0x7E	Under load alarm threshold setting	R/W	10-99%	Word

128	0x7F	Under load trip threshold setting	R/W	10-99%	Word
129	0x08	Under load trip delay setting	R/W	0.1-600	Word
130	0x81	Unbalance alarm threshold setting	R/W	10-80%	Word
131	0x82	Unbalance trip threshold setting	R/W	10-80%	Word
132	0x83	Unbalance trip delay setting	R/W	0.1-600	Word
133	0x84	NECIPTC setting	R/W	0NTC; 1PTC	Word
134	0x85	Temperature alarm value setting	R/W	100-30000	Word
135	0x86	Temperature trip value setting	R/W	100-30000	Word
136	0x87	Temperature trip delay setting	R/W	0.1-600	Word
137	0x88	Temperature returning resistance value setting	R/W	0 closed 1000-30000	Word
138	0x89	Under voltage alarm threshold setting	R/W	50-90%	Word
139	0x8A	Under voltage trip threshold setting	R/W	50-90%	Word
140	0x8B	Under voltage trip delay setting	R/W	0.1-600	Word
141	0x8C	Over voltage alarm threshold setting	R/W	110-150%	Word
142	0x8D	Over voltage trip threshold setting	R/W	110-150%	Word
143	0x8E	Over voltage trip delay setting	R/W	0.1-600	Word
144	0x8F	Over power alarm threshold setting	R/W	100-700%	Word
145	0x90	Over power trip threshold setting	R/W	100-700%	Word
146	0x91	Over power trip delay	R/W	0.1-600	Word
147	0x92	Under power alarm threshold setting	R/W	0-100%	Word
148	0x93	Under power trip threshold setting	R/W	0-100%	Word
149	0x94	Under power trip delay	R/W	0.1-600	Word
150	0x95	Short circuit alarm threshold setting	R/W	400%-700% maximum measurable overload	Word
151	0x96	Short circuit trip threshold setting	R/W	400%-700% maximum measurable overload	Word
152	0x97	Short circuit trip delay	R/W	0.1-600	Word
153	0x98	Phase sequence fault delay setting	R/W	0.1-600	Word
154	0x99	External fault trip delay setting	R/W	0.1-600	Word
155	0x9A	Earthing alarm percentage setting	R/W	20-100%	Word
156	0x9B	Earthing trip percentage setting	R/W	20-100%	Word
157	0x9C	Earthing trip delay setting	R/W	0.1-600	Word
158	0x9D	Reflux detection delay setting	R/W	0.1-600	Word
159	0x9E	Reflux detection control	R/W	0 closed 1 open	Word
160	0x9F	Remote resetting	R/W	Normal 0; remote reset 1	Word
161	0x0A	Contactorm allowed breaking current	R/W	0, OFF, 600-1000%	Word
162	0xA1	Self-start Mode	R/W	0 start; 1 recover	Word
163	0xA2	Self-starting delay setting	R/W	0.1-600	Word
164	0xA3	Self-start control	R/W	0 closed 1 open	Word
165	0xA4	Restarting voltage setting	R/W	75-95%	Word

166	0xA5	Immediate restarting allowed power failure time	R/W	0.1-0.5	Word
167	0xA6	Delay restarting allowed power failure time	R/W	0.5-10.0	Word
168	0xA7	Restarting delay setting	R/W	1.0-6008	Word
169	0xA8	Loss voltage restarting control	R/W	0 closed, 1=starting 1 after restarting, 2=	Word
				starting 2 after starting	
170	0xA9	Parity bit	R/W	0 no parity check 1 odd parity check 2 even parity check	Word
171	0xAA	MODBUS baud rate setting	R/W	1200、2400、4800、9600、19200、	Word
				38400	
172	0xAB	MODBUS address setting	R/W	1-247	Word
173-178	0XAC-0xB1	Hold	R/W		Word
179	0xB2	Starting control setting	R/W	0=protection mode, 1>manual mode	Word
				2=two-step starting, 3=two-speed mode	
180	0xB3	Control authority setting	R/W	0 local, 1 on-site, 2 remote	Word
				3 one in three, 4 all control	
181	0xB4	Starting— delay setting	R/W	0.1-600	Word
182	0xB5	Hold	R/W		Word
183	0xB6	Hold	R/W		Word
184	0xB7	Hold	R/W		Word
185	0xB8	Hold	R/W		Word
186	0xB9	Hold	R/W		Word
187	0xBA	Hold	R/W		Word
188	0xBB	Hold	R/W		Word
189	0xBC	Hold	R/W		Word
190	0xBD	Hold	R/W		Word
191	0xBE	Relay initial status setting	R/W	0 open 1 closed, bit0-4: relay 1-5	Word
192	0xBF	Relay 1 operation setting	R/W	0 electrical level 3-250 unit 0.1s	Word
193	0xC0	Relay 2 operation setting	R/W	0 electrical level 3-250 unit 0.1s	Word
194	0XC1	Relay 3 operation setting	R/W	0 electrical level 3-250 unit 0.1s	Word
195	0XC2	Relay 4 operation setting	R/W	0 electrical level 3-250 unit 0.1s	Word
196	0xC3	Relay 5 operation setting	R/W	0 electrical level 3-250 unit 0.1s	Word
197	0xC4	Definition of programmable output 1	R/W	Alarm fault corresponding to alarm allowable position	Word
198	0xC5		R/W	Trip fault: corresponding trip allowable position	Word

199	0xC6		R/W	Other functions: 2-starting2 、 3-alarm fault output, 4-trip fault output, 5-device self-checking output, 6-device power output, 7-stopping status ready, 8-running status output, 9-controlling output, 10-bus control	Word
200	0x7C	Definition of programmable output 2	R/W	Alarm fault =corresponding alarm allowable position	Word
201	0xC8		R/W	Trip fault=corresponding trip allowable position	Word
202	0xC9		R/W	Other functions: 1-Starting1、 2-Starting2、 3-Alarm fault output, 4-trip fault output, 5-device self-checking output, 6-device power output, 7-stopping status ready, 8-running status output, 9-DI controlling output, 10-bus control	Word
203	0xCA	Definition of programmable output 3	R/W	Alarm fault =corresponding alarm allowable position	Word
204	0xAB		R/W	Trip fault=corresponding trip allowable position	Word
205	0xCC		R/W	Other functions: 1-starting 1、 2-starting 2、 3-alarm fault output, 4-trip fault output, 5-device self-checking output, 6-device power output, 7-stopping status ready, 8-running status output, 9-DI controlling output, 10-bus control	Word
206	0xCD	DI1 programmable definition	R/W	1 normal DI 2 starting 1 (direct starting, turn left, low speed), 3 Starting 2 (turn right, high speed), 4 stopping, 5 reset, 6 emergency stop, 7 external fault, 8 starting/stopping, 9 control authority 1, 10 control authority 11 D0 control	Word
207	0xCE	DI2 programmable definition	R/W	-Ditto-	Word
208	0xCF	DI3 programmable definition	R/W	-Ditto-	Word
209	0x0D	DI4 programmable definition	R/W	-Ditto-	Word
210	0xA1	DI5 programmable definition	R/W	-Ditto-	Word
211	0xD2	DI6 programmable definition	R/W	-Ditto-	Word
212	0xD3	DI7 programmable definition	R/W	-Ditto-	Word
213	0xD4	DI8 programmable definition	R/W	-Ditto-	Word
214	0xD	DI9 programmable definition	R/W	-Ditto-	Word

215-253	OxD6-0XFC	Hold		R/W		Word
254	OxFD	Software version number		R/W	1.0-9.9	Word
255	OxFE	Hold				Word
256	OxFF	Hold				Word
257	OxOI00	Event control parameter		R.	Event switch 0 closed 1 open	Word
258	Event record 1	0x0101	STAI	R.	Protection 1 action pattern 1 overload trip 2 earthing/leakage trip 3 under load trip 4 phase failure trip 5 under voltage trip 6 over voltage trip 7 locked-rotor trip 8 blocking trip 9 unbalance trip 10 temperature trip 11 external fault trip 12 starting overtime trip 13 over power trip 14 under power trip 15 phase sequence trip 16 short circuit trip	High byte
			Month1	R.	Operation 1 time-month	Low byte
259		0x0102	Day1	R.	Operation 1 time-date	High byte
			Hour1	R.	Operation 1 time-hour	Low byte
260		OxOI03	Minute1	R.	Operation 1 time-minute	High byte
			Second1	R.	Operation 1 time-second	Low byte
261-317	Event record 2-20	0x0104-0x13C				57Word

7.3 Profibus_DP

Input data bit 31 characters (ARD-DP Master station)

table 18

Addre	Address	Parameters	Read-	Value range	Type
1	0x00	L1 phase actual current	R.	0-65535	Word
		L1 phase fundamental wave current	R.	0-65535	Word
2	0x01	L2 phase actual current	R.	0-65535	Word
		L2 phase fundamental wave current	R.	0-65535	Word
3	0x02	L3 phase fundamental wave current	R.	0-65535	Word
		L3 phase fundamental wave current	R.	0-65535	Word
4	0x03	Earth leakage current	R.	30-1,000mA	
		Earthing current percentage	R.	0-100%	Word

5	0x04	Uab line-voltage	R.	0-999.9	Word
6	0x05	Ubc line-voltage	R.	0-999.9	Word
7	0x06	Uca line-voltage	R.	0-999.9	Word
8	0x07	Apparent power	R.	0-65535	High byte
9	0x08		R.	0-65535	Low byte
10	0x09	Active power	R.	0-65535	High byte
11	0x0A		R.	0-65535	Low byte
12	0x0B	Electric energy	R.	0-65535	High byte
13	0x0C		R.	0-65535	Low byte
14	0x0D	Power factor	R.	0-1 unit 0.001	Word
15	0x0E	Unbalance degree of current	R.	0-100%	
16	0x0F	Accumulated thermal capacity	R.	0-100%	Word
17	0*10	Temperature value	R.	100-30000	Word
18	0x1A	Motor running time of this time	R.	0-65535 hours	Word
19	0x12	Motor stopping time of this time	R.	0-65535 hours	Word
20	0x13	Switch output	R.	Bit0-Bit8 corresponding switching input DI1-DI9, Bit11 relay 1, Bit12 relay 2, Bits 13 relay 3, Bit14 relay 4 Bit 15 relay 5	Word
21	0x14	Trip fault indicator	R.	Bit0 overload trip Bit1 earthing/earth leakage trip Bit2 under load trip Bit3 phase failure trip Bit4 under voltage trip Bit5 over voltage trip Bit6 locked-rotor trip Bit7 blocking trip Bit8 imbalance trip Bit9 PTC temperature trip Bit10 external fault trip Bit11 starting overtime trip Bit12 over power trip Bit13 under power trip Bit14 phase sequence trip Bit15 short circuit trip	Word
22	0x15	Hold	R/W		Word

23	16x16	Alarm fault indicator	R.	Bit 0 overload alarm Bit1 earthing/earth leakage alarm Bit2 under load alarm Bit3 phase failure alarm Bit4 under voltage alarm Bit5 over voltage alarm Bit6 locked-rotor alarm Bit7 block alarm Bit8 unbalance alarm Bit9 PTC temperature alarm Bit10 external fault alarm Bit11 starting overtime alarm Bit12 over power alarm Bit13 under power alarm Bit14 phase sequence alarm Bit15 short circuit alarm	Word
24	0x17	Hold	R/W		Word
25	0x18	Current specifications:	R.	0-1.6、1-6.3、2-25、3-100、 4-250、5-800、6-1、7-5	
		Current scaling factor	R.	10、100	Word
26	0x19	A phase overload percentage	R.		Word
27	0x1A	B phase overload percentage	R.		Word
28	0x1B	C phase overload percentage	R.		Word
29	0x1C	Overload percentage	R.		Word
30	0x1D	Frequency	R.	45.0-70.0	Word
31	0x1E	Motor status;	R.	Motor thermal overload cooling remaining time	Word
				Bit0 ready; Bit1 stop; Bit2 start Bit3 running; Bit4 alarm; Bit5 trip	

Note: high byte ahead, low byte behind, such as [0][1], [0] is high 8-bit, and [1] is low 8-bit, other analogy. Output parameter 1 character CDP master station-ARD)

This can be displayed specifically as follows:

Output	Parameters	Value range	Remarks
--------	------------	-------------	---------

[00][01]	:Control Word	Bit0: stopping Bit1: starting 1 Bit2: starting 2 Bit 3:remote resetting Bit4: relay 3	0: closed 1: breakover
		Bit15: output data enable bit	When this bit is 1, all operations of Bit0-Bit4 are valid, When it is 0, operations are invalid.

Profibus output data (control data), for example, if it is remotely started, starting mode is selected as “Starting 1”, and output data: Ox8002 (hexadecimal number).

7.4 DeviceNet

Input data bit 14 characters (ARD-DeviceNet Master station)

Address	Address	Parameters	Read-write property	Value range	Type	Remarks
1	[00][01]	Actual current of phase L1	R	0-65535	word	
2	[02][03]	Actual current of phase L2	R	0-65535	word	
3	[04][05]	Actual current of phase L3	R	0-65535	word	
4	[06][07]	Leakage current	R	0-1000mA	word	
		Percentage of earthing current	R	0-100%		
5	[08][09]	Uab-Line voltage	R	0~999.9	word	
6	[0A][0B]	Uab-Line voltage	R	0~999.9	word	
7	[0C][0D]	Uab-Line voltage	R	0~999.9	word	
8	[0E][0F]	Electric energy	R	0-65535	word	High 16-bit electric energy
9	[10][11]		R	0-65535	word	Low 16-bit electric energy
10	[12][13]	Switch output	R	Bit0-bit8 corresponding switching input DI1-DI9, Bit11 relay1, Bit12 relay 2, Bit13 relay 3, Bit14 relay 4, Bit15 relay 5	word	
11	[14][15]	Trip fault indicator	R	Bit0 overload trip Bit1 earthing/earth leakage trip Bit2 under load trip Bit3 phase failure trip Bit4 under voltage trip Bit5 over voltage trip Bit6 locked-rotor trip Bit7 blocking trip Bit8 imbalance trip Bit9 PTC temperature trip Bit10 external fault trip Bit11 starting overtime trip Bit12 over power trip Bit13 under power trip Bit14 phase sequence trip Bit15 short circuit trip	word	
12	[16][17]	Alarm fault indicator	R	Bit0 overload alarm Bit1 earthing/earth leakage alarm Bit2 under load alarm	word	

				Bit3 phase failure alarm Bit4 under voltage alarm Bit5 over voltage alarm Bit6 locked-rotor alarm Bit7 block alarm Bit8 unbalance alarm Bit9 PTC temperature alarm Bit10 external fault alarm Bit11 starting overtime alarm Bit12 over power alarm Bit13 under power alarm Bit14 phase sequence alarm Bit15 short circuit alarm		
13	[18][19]	Current specifications	R	0-1. 6、1-6.3、2-25、3-100、 4-250、5-800、6-1、7-5	word	High 8-bit is current specifications ,low 8-bit is current scaling factor
		Current scaling factor		10、100		
14	[1A][1B]	Motor status	R	Motor thermal overload cooling remaining time Bit0 ready; Bit1 stop; Bit2 start; Bit3 running; Bit4 alarm; Bit5 trip;	word	High 8-bit is motor thermal overload cooling remaining time, low 8-bit is motor operation

Note: For every word type datum, high byte is ahead, low byte behind, such as 0 x [0][1], [0]is high 8-bit, and [1] is low 8-bit. And one more note is that the word data seen from the DeviceNet Master Station shows that low byte comes before the high byte. For example, 0x[00][01] would be shown as 0x[01][00].

Output parameter (1 character, 2 character, DeviceNet Master Station→ARD)

Address	Address	Parameters	Value range	Type	Remarks
1	[00][01]	Control Word	Bit0: stopping Bit1: starting 1 Bit2: starting 2 Bit 3:remote resetting Bit4: relay 3	word	0: closed 1: breakover
			Bit15: output data enable bit		When this bit is 1, all operations of Bit0-Bit4 are valid, When it is 0, operations are invalid.

Note: An example for DeviceNet output data: if it is remotely started, starting mode is selected as “Starting 1”, and output data: 02 80 (hexadecimal number). While writing word data at DeviceNet Master Station, high byte shall be after low byte.

It is not allowed to send two same orders in succession.

8 Typical application solutions

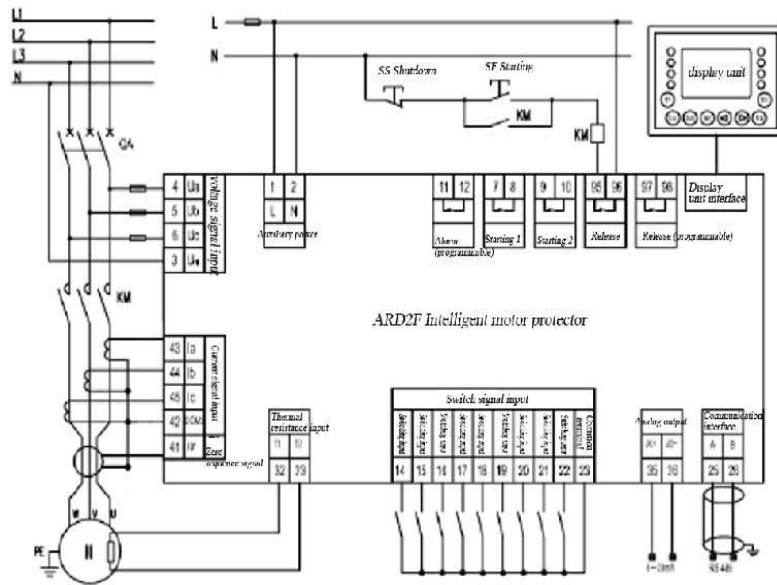

ARD2F motor protector protected mode wiring diagram

Protected mode: the starting or stopping of motor is controlled by external button, the magnetizing coil of contactor KM connects with the normally closed contact of the trip relay using series connection. Close QA, press starting button SF, the magnetizing coil of KM is energized and close the main contactor, then the motor starts; when press stopping button SS, the magnetizing coil of KM is loss of power and trips the main contact, the motor stops.

- Notes: 1. Trip (DO4 programmable) relay can be used for output to realize the quick-break function of moulded case circuit breaker.
2. Programmable relay can be defined as starting 1, starting 2, alarm fault output, trip fault output, device self-checking output, device power output, stopping status ready, running status output, DI controlling output, bus control.

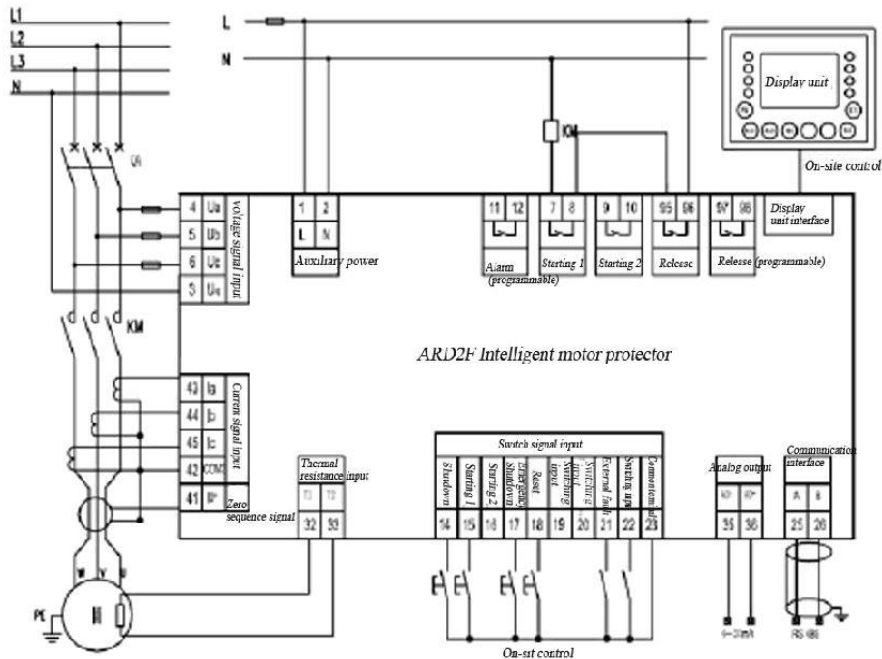

ARD2F motor protector direct starting mode wiring diagram

Direct starting : the starting or stopping of motor is controlled by protector, the magnetizing coil of contactor KM connects

with the normally closed contact of the trip relay and normally open contact of starting 1 relay using series connection, close QA, press “Starting I” button on the display unit (starting control is set to manual mode, enable On-site control) to close the main contactor of KM, then the motor starts; when pressing “stopping” button, the magnetizing coil of KM is loss of power and trips the main contactor, the motor stops.

Control authority selection (except protection mode): 90L display unit button On-site control, DI terminal on-site control, PC communication remote control. DI6 and DI7 are combined to achieve three-position authority selection. In the table below, “0” means the control authority is not connected, “1” means connected.

DI control authority definition:

Table 20

Switching input	DI input status	
	DI6 control authority 1	DI7 control authority 2
On-site control	1	0
Remote control	0	0
On-sit control	0	1

ARD2F motor protector YI :::: starting mode wiring diagram

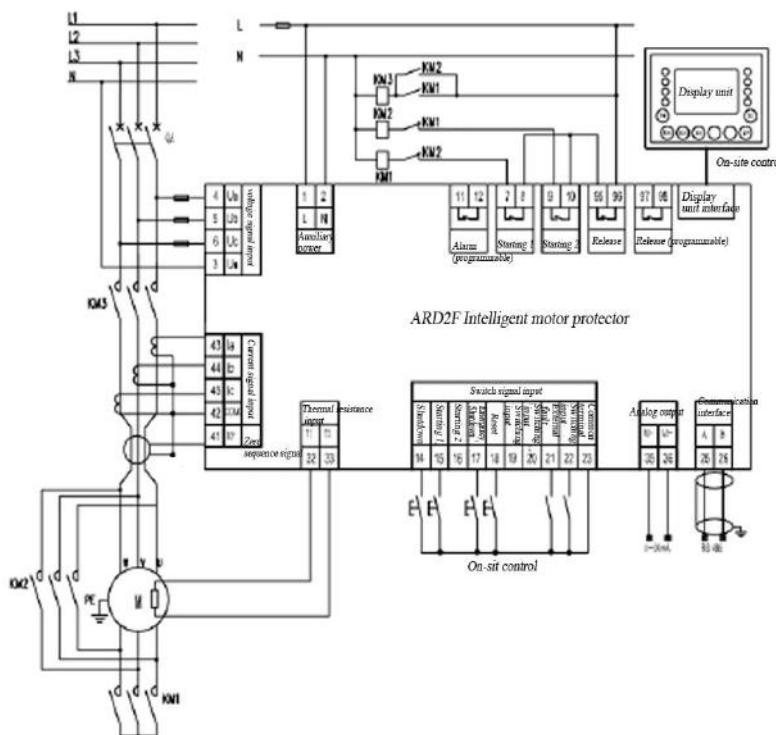

Y- Δstarting: motor starting and stopping are controlled by the protector. "According to the method illustrated, after the control circuit is connected, and then close QA, press the "start I" " button on display unit, (starting control is set to start in two steps to enable On-site control), enable the starter relay 1 to close, KM1 KM3 attract coil to energize, and main contactor of KM1 KM3 to close. The motor is started by Y way, when reaches conversion time, the protector will automatically disconnect starter relay 1, while close the starter relay 2. KM2, KM3 attract coil is energized, and close main contactor of KM2, KM3; the protector turns into A running, press the "" stop "" button, and the motor will stop working."

ARD2F motor protector soft starter starting mode wiring diagram

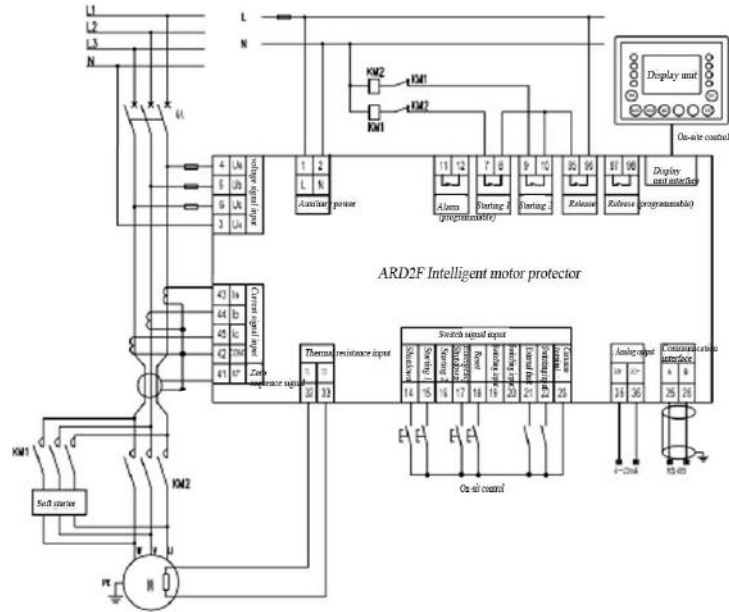

Soft starter starting: under the soft starter starting mode, motor starting and stopping are controlled by the protector. "According to the method illustrated, after the control circuit is connected, and then close QA, press the "start I" " button on display unit, (starting control is set to start in two steps to enable be On-site control), enable the starter relay 1 to close, KM1 attract coil to energize, and main contactor of KM1 to close. The motor is started by soft starter, when reaches conversion time, the protector will automatically disconnect starter relay 1, while close the starter relay 2. KM2 attract coil is energized to enable main contactor of KM2 to close; the motor turns into normal running, press the ""stop"" button, KM1 attract coil will loss power to trip main contactor of KM1, and the motor will stop working."

ARD2F motor protector reversible starting mode wiring diagram

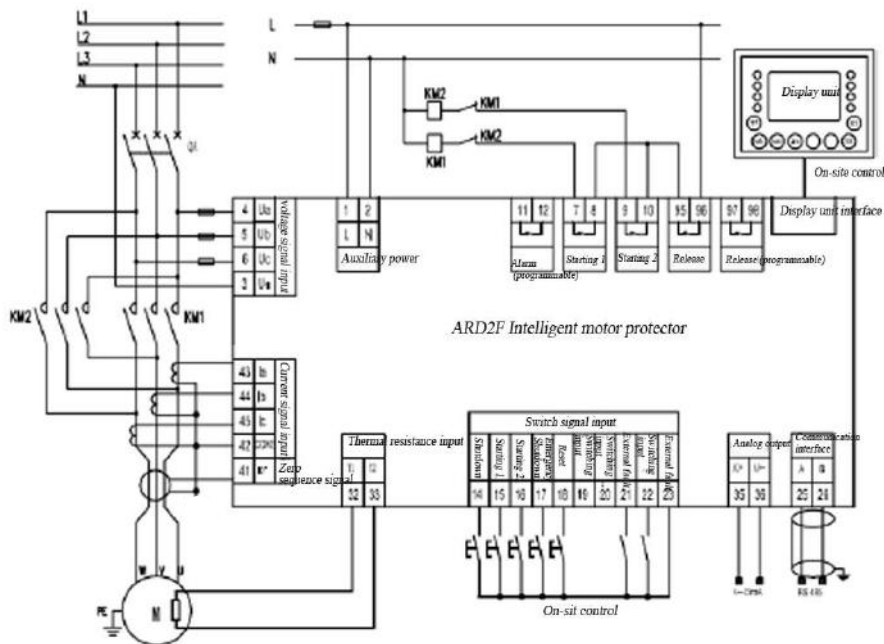

Reversible start: motor starting, stopping are controlled by protector. "According to the method illustrated, after the control circuit is connected, and then close QA, press the "start I" " button on display unit, (starting control is set to manual mode to enable be On-site control), so that KM1 attract coil is energized, and main contactor of KM1 is closed. The motor is to start normally: "

"Press" " Start 2" " button, KM2 attract coil will be energized to enable main contactor of KM2 to close, and the motor will back start; press the "stop" " button, KM1, KM2 will disconnect and the motor will stop working."

ARD2F motor protector step-down starting mode wiring diagram

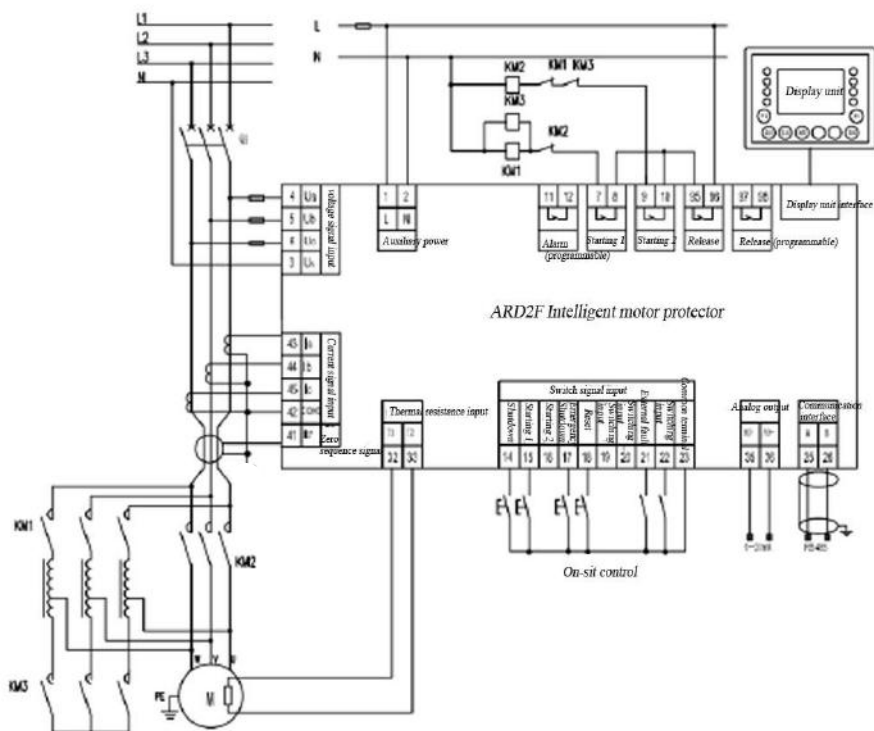

Starting from the self-coupling pressure-reduce start : under the self step-down starting mode, motor starting and stopping are controlled by the protector. "According to the method illustrated, after the control circuit is connected, and then close QA, press the "start I" " button on display unit, (starting resistance control is set to start in two steps to enable be On-site control), enable the starter relay 1 to close, KM1 attract coil is then energized, and main contactor of KM1 is closed. The motor is started by the reduced pressure of self-coupling transformer, when reaches conversion time, the protector will automatically disconnect starter relay 1, while close the starter relay 2. KM2 attract coil is energized to enable main contactor of KM2 to close; the motor turns into normal running, press the ""stop"" button, KM1 attract coil will loss power to trip main contactor of KM1, and the motor will stop working."

9 settings and instructions of protection function

9.1 Parameter setting -

Table 21

No.	Main menu	Function	Sort	Setting ranges	Default value	Unit
I	Alarm information					
II	Trip Information					
III	Operation INFORMATION	1 this run				h
		2 this				h
		(3) Running				h
		stopping time				h
		number of starts				
		6 Number of trips				
IV	system parameter	1 Baud rate		2400、4800、9600、19200、38400	9600	bps
		2 Postal		1-247	1	
		3 Enter the password		0-9999	1	
		4 Motor Type		General motor, safety-increased motor	Common motor	
		5 Transmission Type		Ia, Ib, Ie, lay, Uab, Ubc, Uca, Uay, PTC, heat Capacity, P, F	lay	
		6 transmission ratio		1-8	2	
		7 backlight lit		On/off	OFF	
		8.System voltage		380、660	380	V
		9.Rated frequency		45-65	50	

		10.Rated power		0.4-1.6 1.6-6.3 6.3-25 25-100 63-250 250-800	1056、 4158、 16500、 66000、 165000、 480000	w
		11.CT ratio		1-1000	1	
		12 local speed switch		On/off	OFF	
		13.fundamental wave switch		On/off	OFF	
		14.Software Version No.				
V	Protection parameter	1. starting protection	Starting time	0.1-999.9	10.0	s
			Alarm	On/off	OFF	
			Trip	On/off	ON	
		2.overload protection	Rated current of motor	0.1-1.6 1.6-6.3	A	
				6.3-25	25.0	
				25-100	100	
				63-250	250	
				250-800	800	
			Trip class	1, 2,3,5,10,15,20	5	Level
				25、 30、 35、 40		
				2、 3、 4、 5、 6、 8、 10、	2	s
				12、 15		
			Alarm threshold	1-99%	85	%
			Alarm	On/off	OFF	
			Trip	On/off	ON	
			Overload automatic	On/off	OFF	

			Cooling time	1-30	30	min
		3 under load protection	Alarm threshold	10-99%	70	%
			Trip threshold value	10-99%	50	%
			Trip delay	0.1-600	5.0	s
			Alarm	On/off	OFF	
			Trip	On/off	OFF	
		4Phase failure protection	Trip delay	0.1-600	1.0	s
			Alarm	On/off	OFF	
			Trip	On/off	ON	
		5 phase sequence	Trip delay	0.1-600	1.0	s
			Alarm	On/off	OFF	
			Trip	On/off	ON	
		6 unbalance protection	Alarm threshold	10-80%	20	%
			Trip threshold value	10-80%	30	%
			Trip delay	0.1-600	5.0	s
			Alarm	On/off	OFF	
			Trip	On/off	OFF	
		7 Earthing / Earth leakage	Transformer input	On/off	OFF	
			Earthing alarm	20-100%	20	%
			Earthing trip threshold	20-100%	50	%
			Trip delay	0.1-600	0.1	s
			Earth leakage alarm current	100-1000	200	mA
			Earth leakage trip current	100-1000	300	mA
			Trip delay	0.1-600	0.5	s
			Alarm	On/off	OFF	

			Trip	On/off	OFF	
		8 Short-Circuit	Alarm threshold	400-700% max. measurable overload times	400	%
			Trip threshold value	400-700% max. measurable overload times	500	%
			Trip delay	0.1-600	0.1	s
			Alarm	On/off	OFF	
			Trip	On/off	OFF	
		9 Over voltage	Alarm threshold	110-150%	110	%
			Trip threshold value	110-150%	120	%
			Trip delay	0.1-600	5.0	s
			Alarm	On/off	OFF	
			Trip	On/off	OFF	
		10 Under voltage	Alarm threshold	55-90%	90	%
			Trip threshold value	55-90%	80	%
			Trip delay	0.1-600	5.0	s
			Alarm	On/off	OFF	
			Trip	On/off	OFF	
		11 Pei-rotor protection	Alarm threshold	100-700%	500	%
			Trip threshold value	100-700%	600	%
			Trip delay	0.1-600	5.0	s
			Alarm	On/off	OFF	
			Trip	On/off	OFF	
		12 blocking protection	Alarm threshold	100-700%	150	%

			Trip threshold value	100-700%	250	%
			Trip delay	0.1-600	5.0	s
			Alarm	On/off	OFF	
			Trip	On/off	OFF	
		13 overpower protection	Alarm threshold	100-700%	150	%
			Trip threshold value	100-700%	250	%
			Trip delay	0.1-600	5.0	s
			Alarm	On/off	OFF	
			Trip	On/off	OFF	
		14 under power protection	Alarm threshold	0-100%	80	%
			Trip threshold value	0-100%	50	%
			Trip delay	0.1-600	5.0	s
			Alarm	On/off	OFF	
			Trip	On/off	OFF	
		15 temperature	PTC type	On/off	ON	
			Return resistance	0 closed 1000-30000	0	Ω
			Alarm	100-30000	1600	Ω
			Trip	100-30000	3600	Ω
			Trip delay	0.1-600	5.0	s
			Alarm	On/off	OFF	
			Trip	On/off	OFF	
		16 External	Trip delay	0.1-600	5.0	s

			Alarm	On/off	OFF	
			Trip	On/off	OFF	
VI	Control parameter	1 control authority	Switching input	local, on-site, remote I. Full-controlled	Full-controlled	
		(2) Starting Control.	Starting Mode	Protection mode, manual mode, two-step Mode, two-speed mode	protection mode	
			Starting delay	0.1-600	3.0	s
		self-start	Self-start Mode	reset/ start	Starting	
			Self-start delay	0.1-600	5.0	s
			Self-start control	On/off	OFF	
		4 Loss	voltage	75-95%	80	%
			Immediately restarting power failure time	0.1-0.5	0.1	s
			Allowable	0.5-10.0	5.0	s
			Restarting	1.0-60.08	30.0	s
			Controls	0 OFF, 1 start 1, 2 start2	OFF	
		5 reflow inspection	Delay setting	0.1-600		s
			Controls	On/off	OFF	
		6 D03 programmable Setting	Programmable setting	1 - Start 1, 2 - Start 3 - alarm fault output, 4 - trip fault output, 5 - device self-checking output 6 - device power output, 7 - stopping state ready 8 - running state output, 9-DI control output, 10 - Bus control	3	
			Action time setting	0-250	0.1	s

		7D04 programmable Setting	Programmable setting	1 - Starting1, 2 - Start 2, 3 - alarm fault output, 4 - trip fault output, 5 - device self-checking output 6 - device power output, 7 - stopping state ready 8 - running state output, 9-DI control output, 10 - Bus control	3	
			Action time setting	0-250	0.1	s
			Trip fault setting	0-65535	65535	
		8DI9 programmable Setting	DI9 programmable setting	1 common DI 2 Start 1 (direct start, turn left, low speed 3 start 2 (turn right, high speed), 4 shutdown 5 Resetting, 6 Emergency shutdown 7 external fault 8 start / stop, 9 control authority 1 10 control authority 2 11 two-wire start-stop		
		9TEST	D02	On/off	OFF	
			D03	On/off	OFF	
			D04	On/off	OFF	
			D05	On/off	OFF	

9.2 Function instructions

Each type of protection work periods : Table 22

Type of protection	Working periods
Phase sequence, external fault, over voltage, under-voltage	Stop
Phase sequence, external fault, over voltage, under-voltage, phase failure, earth leakage/earthing, locked- rotor, starting overtime	Starting

Phase sequence, external fault, over voltage, under-voltage, phase failure, earth leakage and earthing, overload, unbalance, blocking, under load, under power, over power, temperature, short circuit	Run
--	-----

- Starting overtime protection
(Reference ARD2 Function instructions)
- Overload Protection
(Reference ARD2 Function instructions)
- Under load Protection
(Reference ARD2 Function instructions)
- Phase failure protection
(Reference ARD2 Function instructions)
- unbalance protection
(Reference ARD2 Function instructions)
- t_E time protection (suitable for safety-increased motor)

After the AC winding reaches the rated operation stable temperature at maximum ambient temperature for safety-increased motors, the desired time from the beginning of locked-rotor current to the time rising to limiting temperature is t_E . The t_E time of safety-increased motors is usually provided by the motor manufacturers, and users can find the data on the motor nameplate.

When providing locked-rotor and within the t_E time, disconnect the thermal overload protection of electric motor, only after the motor starting is completed, the independent delay timer can be applied.

Delay timer with independence. t_E protection characteristic curve action delay table shown in Table 22, and curve diagram as shown below.

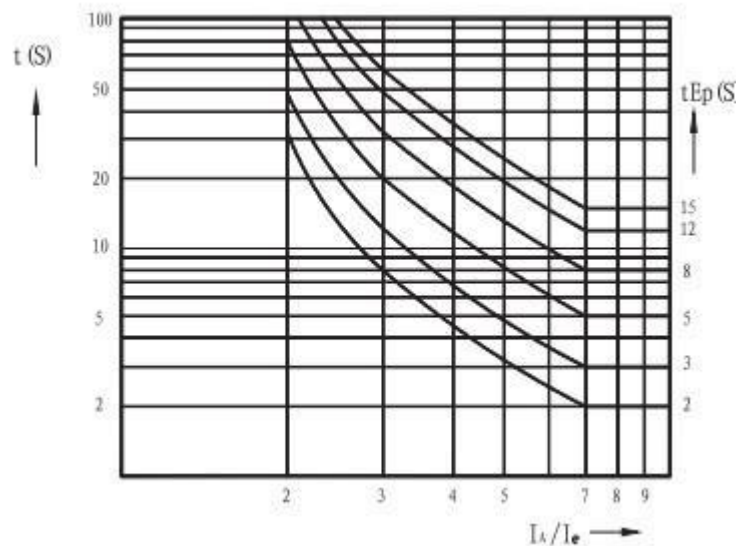

t_E protection delay and locked-rotor current ratio I_A/I_e 's current-time characteristic curve

t_{Ep} : Allow locked-rotor time when under 7 times rated current; I_A : locked-rotor current; I_e : rated current of motor.

Action Delay Characteristics Table

Table 23

tEp set Set IAIe	2(S).	3(S).	4(S).	5(S).	6(S).	8(S).	10(S).	12(S).	15(S).
2.0	32	48	64	80	96	128	160	192	240
2.2	20.27	30.4	40.54	50.67	60.81	81.08	101.35	121.62	152.02
2.4	14.75	22.12	29.5	36.87	44.25	59	73.75	88.5	110.63
2.6	11.54	17.32	23.09	28.87	34.64	46.19	57.74	69.29	86.62
2.8	9.46	14.19	18.92	23.65	28.39	37.85	43.31	56.78	70.97
3.00	8	12	16	20	24	32	40	48	60
3.20	6.91	10.37	13.83	17.29	20.75	27.67	34.59	41.51	51.88
3.40	6.08	9.13	12.17	15.22	18.26	24.35	30.44	36.52	45.66
3.60	5.43	8.14	10.86	13.58	16.29	21.72	27.16	32.59	40.74
3.80	4.9	7.35	9.8	12.25	14.7	19.6	24.5	29.41	36.76
4.00	4.46	6.69	8.93	11.16	13.39	17.86	22.32	26.79	33.48
4.20	4.09	6.14	8.19	10.24	12.29	16.39	20.49	24.59	30.74
4.40	3.79	5.68	7.58	9.47	11.37	15.06	18.95	22.74	28.42
4.60	3.52	5.28	7.05	8.81	10.57	14.1	17.62	21.15	26.43
4.80	3.29	4.94	6.59	8.24	9.88	13.08	16.48	19.77	24.72
5.00	3.09	4.64	6.19	7.74	9.29	12.38	15.48	18.58	23.22
5.20	2.92	4.38	5.84	7.3	8.76	11.68	14.6	17.53	21.91
5.40	2.76	4.15	5.53	6.91	8.3	11.07	13.83	16.6	20.75
5.60	2.63	3.94	5.26	6.57	7.89	10.52	13.15	15.78	19.73
5.80	2.5	3.76	5.01	6.27	7.52	10.03	12.54	15.05	18.81
6.00	2.4	3.6	4.8	6	7.2	9.6	12	14.4	18
6.20	2.3	3.45	4.6	5.75	6.9	9.2	11.51	13.81	17.26
6.40	2.21	3.32	4.42	5.53	6.64	8.85	11.07	13.28	16.6
6.60	2.13	3.2	4.27	5.33	6.4	8.54	10.67	12.81	16.01
6.80	2.06	3.09	4.12	5.16	6.19	8.25	10.32	12.38	15.48
7.00	2	3	4	5	6	8	10	12	15
8.00	2	3	4	5	6	8	10	12	15
9.00	0.2	0.2	0.2	0.2	0.2	0.2	0.2	0.2	0.2

Note: (a) t_E protection time = operation time $12 \times t_E$ setting when Ep is 2 (S) :

(b) when t_E is set to 5 (S), t_E value by starting current ratio IAI Ie is determined according to IEC79-7, GB3836.3-2000

standard, when apply to safety-increased motor tE protection, its inverse time overload may refer to characteristic curve settings. To ensure that the power is turned off before the time when the motor companying rotating, the inverse time curve of overload protection should be down about 15%.

(c) The action time of "tE protection is achieved by setting ""Motor Type"" and "" trip class"" according to Table 9 ". t_{EP} (trip class) selects the appropriate trip curves. "(When the motor type is selected to ""safety-increased motors", the "trip class will automatically become tEp setting: Otherwise, the trip curve is inverse time overload trip curve of normal motor."

■ phase sequence protection

When the protector detects the error of voltage phase sequence of the motor, the locking motor will start to protect the motor safety.

■ Short circuit protection

(Refer to ARD2 function instructions)

■ Earthing/ Earth leakage Protection

(Refer to ARD2 function instructions)

■ Over voltage protection

Too high voltage will result in extent damage of motor insulation, and when the operating voltage of motor exceeds the protection voltage, the protector will protect according to the set requirements, and trip within the trip (delay) setting time.

■ Under voltage protection

Too low voltage will cause the motor speed to reduce, or even stop, when the operating voltage of motor drops to the under voltage protection set, the protector will protect according to the set requirements, and trip within the trip (delay) setting time.

■ Locked-rotor protection (starting over current protection)

(Reference ARD2 Function instructions)

■ Blocking protection

(Reference ARD2 Function instructions)

■ Over power protection

When the percentage of load power and rated power is higher than the preset action value, the protector will act or alarm within the action time set.

■ Under power protection

When the percentage of load power and rated power is lower than the preset action value, the protector will act or alarm within the action time set.

■ Temperature protection

Motor temperature protection regards the thermistor values sent by thermistor detector embedded in the motor's stator windings or bearings as the protection conditions. When the protector detects that the value of the thermistor is larger than the preset protection value, the protector will trip

■ Within trip(delay) set time.

External fault protection (technology interlock protection) (refer to ARD2 function instructions)

■ Control authority

Protector has a variety of control authority, and users can set different control authority to control the motor according to the actual needs.

"Full-controlled: when the users set the control authority to ""full-controlled"", then the users can press a button on the display unit to achieve On-site control."

System, PC remote control, DI termination to achieve On-site control starting and stopping of motor.

The starting and stopping of protector can only be controlled by local Z via using the keys on the display unit.

The starting and stopping of protector can only be controlled by on-site Z via DI input terminal on the protector. Remote: the starting and stopping of protector can only be controlled via remote communication of PC.

One in three by using DI end to select the control position (select one from local, on-site, and remote).

■ Starting control

The protector has different start control mode, and the users can select different start control way according to the actual situation.

Protection mode 2, under this mode, the protector can not be controlled by local and on-site.

Manual mode: under this mode, it is need to manually control 2 starter relay separately.

Two-step Z mode, under this mode, only need to adopt manual operation for start 1, after the set delay time, start 1 will automatically disconnect and simultaneously start 2 action. If the self-start function is opened up, when the protector is power on, it will start 1 and start 2 relays in automatic sequence of actions.

" Two-speed mode: under this mode, ""start 1"" is low-speed operation, and ""start 2"" is high-speed operation."

■ self-start

During power up or power restoration process, the protector will start the motor according to setting sharing.

" If the self-start control of system is ""open", and "self-start mode is set to ""restore"", then the protector will determine whether there is need to re-start based on the state before power off, if the system is running before power off, then it will start to run according to the set self-start delay time after power on; if the self-start mode is ""start"", then the protector can achieve motor group delay time sequence starting once power on."

■ loss voltage restart

"This function is only valid when with voltage function and loss voltage restart function must be set to ""start 1"" or ""start 2"" state, while there is need to close the under voltage trip function."

When the motor is running and zero current is detected, then begin timing under loss of pressure; within immediate time of loss voltage, if the voltage can be restored to voltage setting set under the loss of pressure starting, the starter relay is not tripd; when after the greater immediate time of loss of pressure, the starter relay will be tripd. If the voltage can be restored to voltage setting set under the loss voltage restarting within the time, the protector will start the motor under delay after delay restart. When power failure time is greater than the loss voltage restarting time allowed, this eliminates relevant information, no re-start any more.

Notes: "1. two-speed motor starting time, overload, under load, locked-rotor, blocking, over power, under power, short circuit in two sets, when carry out setting, there is need to select low-speed switch in system parameters firstly"; "OFF" is the low-speed parameter setting"; "ON" is the high-speed parameter setting."

2. 4 to 20 analog output: Default 20 mA corresponds to 2 times the rated current value. Users can also set their own required corresponding parameters and magnification of analog output (note: magnification setting is only valid for the current). See the below table:

Transmission setting instructions as flows:

Table 24

Transmission type	Transmission magnification
0, A -phase current	Ie integral multiples (1-8)
1. B -phase current	Ie integral multiples (1-8)
2. C -phase current	Ie integral multiples (1-8)
3. mean current	Ie integral multiples (1-8)
4. AB line voltage	95-190,330-990,190-570 (50% -150% system voltage) corresponds to 4-20mA
5. BC line voltage	95-190,330-990,190-570 (50% -150% system voltage) corresponds to 4-20mA
6. CA line voltage	95-190,330-990,190-570 (50% -150% system voltage) corresponds to 4-20mA
7. Average line voltage	95-190,330-990,190-570 (50% -150% system voltage) corresponds to 4-20mA

8. PTC (100-30K)	Default 100-30000 corresponds to 4-20mA
Thermal capacity	Default 0-100% corresponds to 4-20mA
10. Power	Rated power integral multiple (1-8)
11. Frequency	30-70Hz corresponds to 4-20mA

10 Cautions

1. The trip relay (terminal no.95, 96) is normally open, and closed after power on.
2. The protector can not display real-time "alarm information, which can only display alarm condition when enter the query menu." Customers are advised to view when the fault alarm is stable.
3. The protector can measure 7.2 times overload current of specifications ordered in maximum, namely, 100A protector can measure 720A current in maximum.
When set the short-circuit protection, customers need to set reasonable parameters according to specifications set by the protector.
4. when the start control of protector is set to "two-step start", "starting – delay" time should be less than the start time."
5. Pei-rotating protection trip delay time should be less than the starting time, otherwise the locked-rotor protection function will not be achieved.
6. When the protector is equipped with earthing / earth leakage protection, the conducting wire of \ protector introduced from zero sequence current transformer is recommended to use shield wire, otherwise this may lead to inaccurate measurements.
7. Protector provides asynchronous half-duplex RS485 communication interface, adopt MODBUS-RTU protocol, and a variety of data can be transmitted on the communication line. . Communication connection is recommended to use shielded twisted pair wire whose diameter should be not less than 0.5mm². When wiring, make communication lines away from power cable or other strong electric field environment.
8. The rated current of protector should be proper rated operational current value of the motor; if this setting value is lower than the normal value of the motor's rated operational current, it may cause that the motor can not be started normally; higher than normal rated operation current value of motor, the protector may not carry out normal protection when the motor appears fault.
9. Once the protector occurs trip, the protector should be reset after debugging and before re-start the motor, otherwise it will not start the motor.
10. After the thermal overload protection of motor, due to the heat accumulation, it can be reset after cooled.
11. In the actual use on-site, the unreasonable protection parameters settings may cause the motor to has protection action once the motor started or no protection action; at this time, all protection functions can be turned off, various protection parameters can be reset in accordance with various parameters obtained from normal operation of the motor.
12. if the various protection parameters set by protection are appropriate, but the protector has action once the motor started, at this time, the cause of fault can be found according to the action code displayed by protector.
13. The protector's parameters are default settings when made(unless users have special requirements); In actual use, various protection functions must be opened by users based on the actual needs, and various parameters can be set.
14. Unless otherwise specified by users, the connecting line of transformer and protector body is 1m in default, and the connecting line of protector body and display unit is 1.5m in default.
15. Special requirements should be specified in the order if users have special requirements(such as single-phase motor protector, length of connection line, etc.)。

11 Order sample

Example Type: ARD2F-25/QTJCSR+90L Auxiliary power supply: AC220V

Rated current of motor: 6.3A ~ 25A applies z three-phase motor

Measurement parameters: three-phase current, temperature resistance

Additional function : start control, thermal protection, alarm output, RS485 communication, 20 display methods of SOE event records,

90L (Chinese LCD)

1. Overview

ARD3 series intelligent motor protectors (hereinafter referred to as the protector), adopt advanced single-chip microcomputer technology which has many features like strong anti-interference capability, stable and reliable performance, digital, intelligent and networked, etc. Protector can protect motors from many faults during the motor running such as starting timeout, overload, locked rotor/block, phase failure, unbalance, under load, grounding, earth leakage, over voltage, under voltage, phase sequence, overpower, under power, temperature, external faults, etc. and is equipped with SOE fault event log function which is convenient for maintenance staff to find the causes of the problems, and display the running state clearly and intuitively through LCD in Chinese in four lines, status indicators and other ways. It is suitable for coal mine, petrochemical, metallurgy, electric power, shipbuilding, civil construction and other fields. The protector has RS485 remote communication interface and DC4-20mA analog output, which is convenient to form a network system together with control machines like PLC and PC to realize the remote control of motor running.

2. Product type

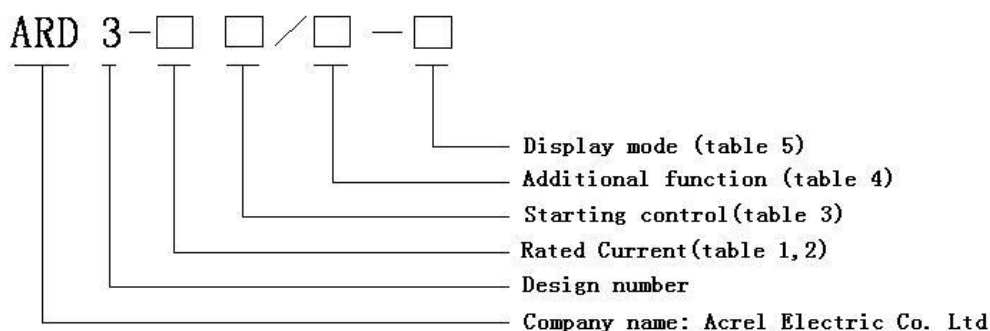

Table 1 Rated current

Rated current for protector	CT transformer ratio	Turns of Transformer(Primary)	Rated power of motor (kW)	Range of setting current (A)
1	Yes	5	0.12-250	0.1-999
5		1	0.12-250	0.1-999
1.6	No	1	0.12-0.55	0.4-1.6
6.3		1	0.75-2.2	1.6-6.3
25		1	3-11	6.3-25
100		1	15-45	25-100
250		1	55-132	63-250
800		1	160-250	250-800

Table 2 Rated current additional explain

Rated power of motor (kW)	Rated current of motor(A)	Rated current for matching protector	Range of setting current	Rated power of motor (kW)	Rated current of motor(A)	Rated current for matching protector	Range of setting current
0.12	0.42	1.6	0.40-1.6	30	57	100	25-100
0.37	1	1.6	0.40-1.6	37	69	100	25-100
0.55	1.5	1.6	0.40-1.6	45	81	100	25-100
0.75	2	6.3	1.6-6.3	55	100	100	25-100
1.1	2.5	6.3	1.6-6.3	75	135	250	63-250
2.2	5	6.3	1.6-6.3	90	165	250	63-250

3	6.5	25	6.3-25	110	200	250	63-250
5.5	11	25	6.3-25	132	240	250	63-250
7.5	14.8	25	6.3-25	160	285	800	250-800
11	21	25	6.3-25	200	352	800	250-800
15	28.5	100	25-100	220	388	800	250-800
18.5	35	100	25-100	250	437	800	250-800
22	42	100	25-100	/	/	/	/

Note: Data in table 1 are suitable to AC400V, 50Hz, 1500r/m four phase squirrel cage motor

Table 3 Starting control

Starting control	Code
Manual mode 1)	A
Two-step Z mode 2)	H
Two speed mode	F
Protect mode	J

Table 4 Additional function

Additional function		Code
Communication port	Modbus-RTU	C
	Profibus-DPV0	CP
Residual current protection (leakage)		L
Voltage function (power, power factor)		U
Temperature protection		T
4-20mA analog output		M
tE time protection		tE
electric energy		EP
Anti-interference electricity protection		SU (include U and SR function)
fault record		SR

Table 5 Display mode

Display mode	Code
The size of LCD liquid display module is 90*70, hole of 86*66 (unit: mm)	90L

Note:

1. The protector provides more than one Additional function, and provides only one Rated current and one starting control, for example, a motor rated current is 45A, Manual mode control the starting, and the protector need Communication function, Residual current protection, Temperature protection and Display mode, so the ARD3 protector type is ARD3-100T/LTC-90L.
2. Residual current includes grounding current and leakage current, only one can be chosen. The grounding current is the superposition of three phase current vector sum, and leakage current can be detected by zero sequence transformer. Leakage current signal rang should be marked when ordering for easy production setting.
3. 4-20mA analog output factory default is 2 times the rated current value, that is to say 2 times the rated current value correspond to 20mA, 0 to 4mA. The customer can choose corresponding analog electrical parameters, such as phase A current, phase B current, phase C current, line AB voltage, line BC voltage, line AC voltage, active power and so on. DC

4mA is corresponding to the minimum of selected variable,DC 20mA is corresponding to the maximum of selected variable. Mark the specific requirements before ordering, otherwise set in default.

4.Overload protection is tE time protection or inverse-time overload protection,inverse-time overload protection in default,mark in the order if tE time protection is needed, otherwise set in default.

5.Motor protector can be used with current transformer and residual current transformer which consistent with the same product number.

6. Modbus-RTU(C) and Profibus-DPV0(CP)only one can be chosen.

3 General technical index

Technology specifications are as shown in table 6.

Table 6 Technology specifications

Technical parameters	Technical index	
Auxiliary power supply of the	AC 85V~220V ,DC 100V~350V, power dissipation 15VA	
Motor rated operating voltage	AC 220V/380V/AC660V, 50Hz/60Hz	
Motor rated operating current	1A(0.1A-9999A)	Small special current transformers are used.
	5A(0.1A-9999A)	
	1.6A(0A-1.6A)	
	6.3A(1.6A-6.3A)	
	25A (6.3A-25A)	Special current transformers are used.
	100A (25A-100A)	
	250A (63A-250A)	
800A (250A-800A)		
Relay output contactor Capacity	5 DO,resistive load	AC250V、6A
On-off input	9 DI, opto-coupler insulation	
Telecommunication	RS485 Modbus RTU、 Profibus DP protocol	
Environment	Working Temperature	-10°C~55°C
	Storage temperature:	-20°C~70°C
	Relative humidity	5%~95% no condensation
	Altitude	≤2000m
Classes of pollution	Level 2	
Degree of protection	Main part IP20, display unit IP45	
Installation category	Class III	

4 Outline dimensions and installation (unit: mm)

4.1 Appearance of main part control module, as shown in figure 1.

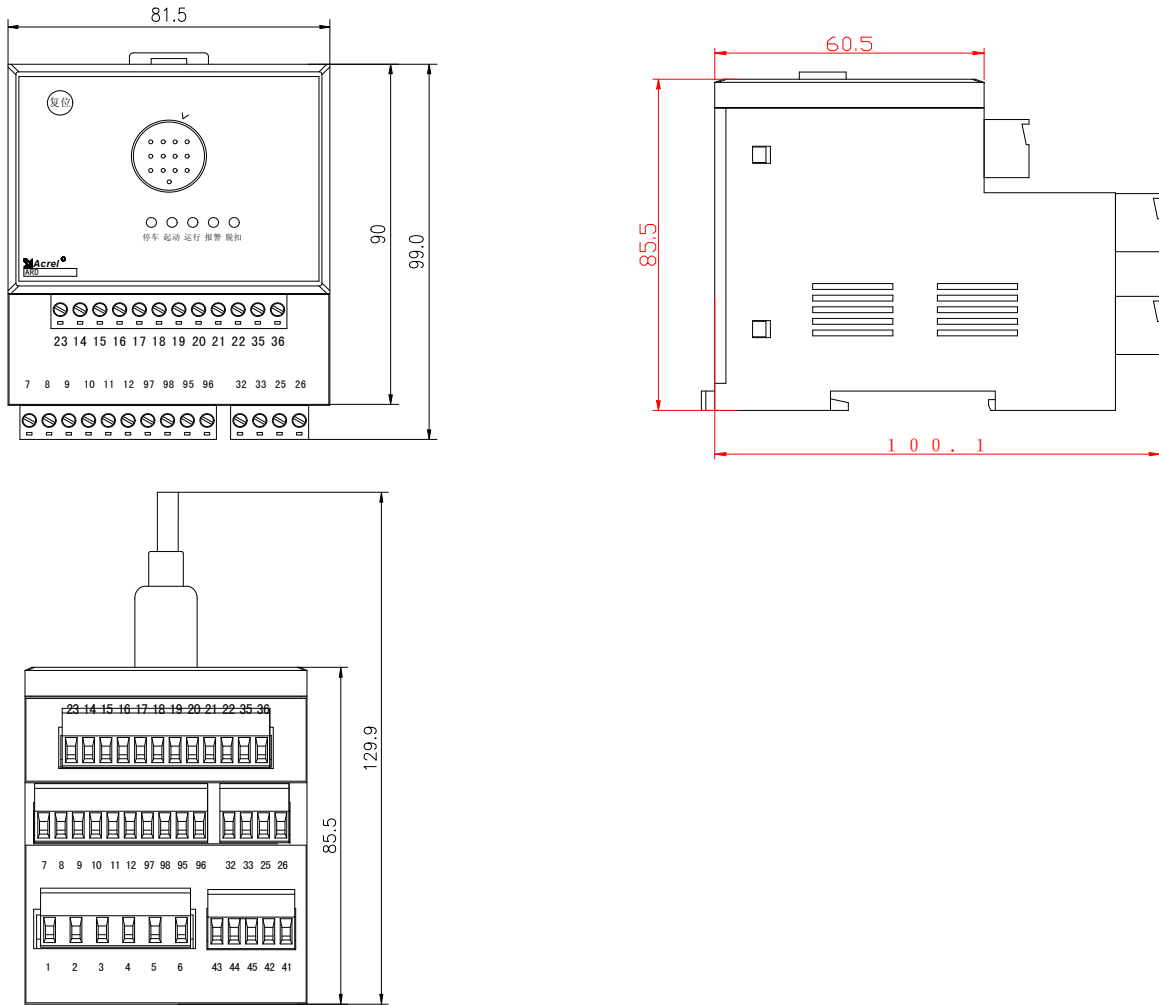

Figure 1 ARD3 Main part control module dimension

4.2 Mounting dimension of protector display unit

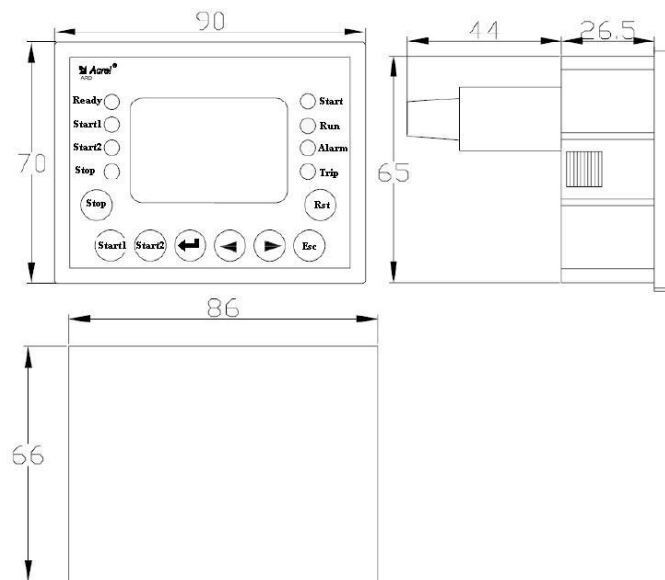

Figure 2 Mounting dimension of protector display unit

4.3 Transformer mounting dimension of less than 100A

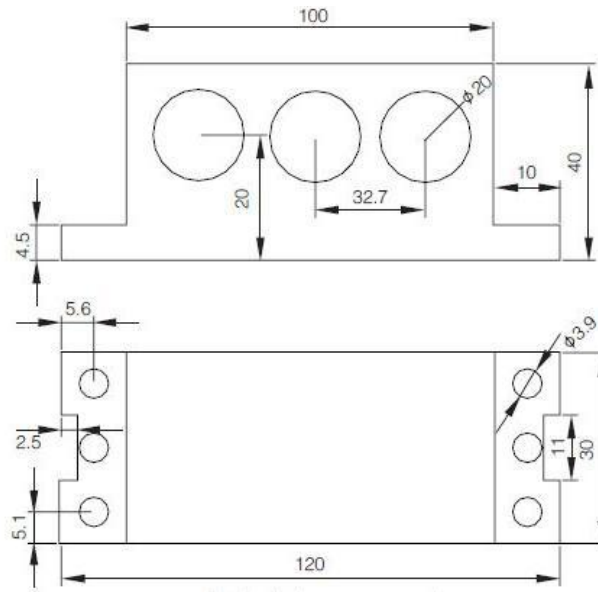

Figure 3 Transformer mounting dimension of less than 100A

4.4 Outline dimensions of 250A outlay current transformer

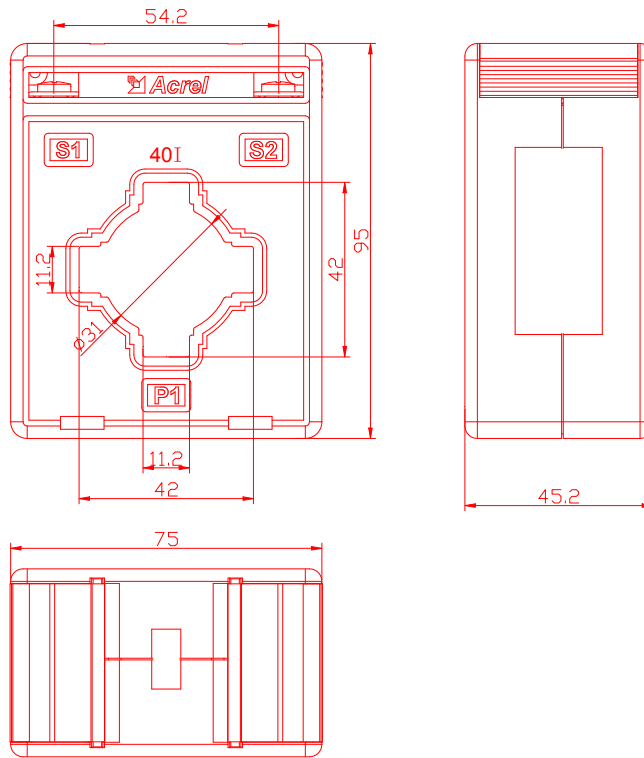

Figure 4 Outline dimensions of outlay current transformer

4.5 Outline dimensions of 800A outlay current transformer

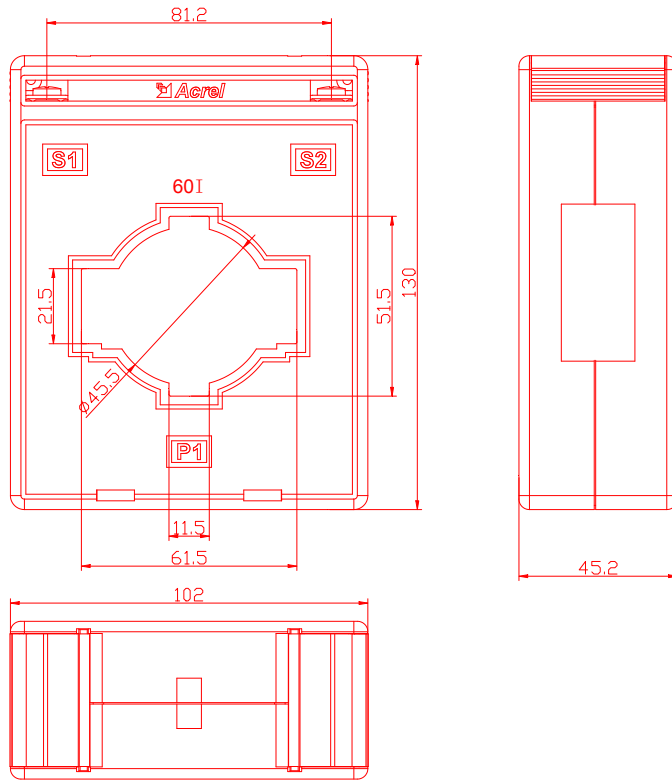
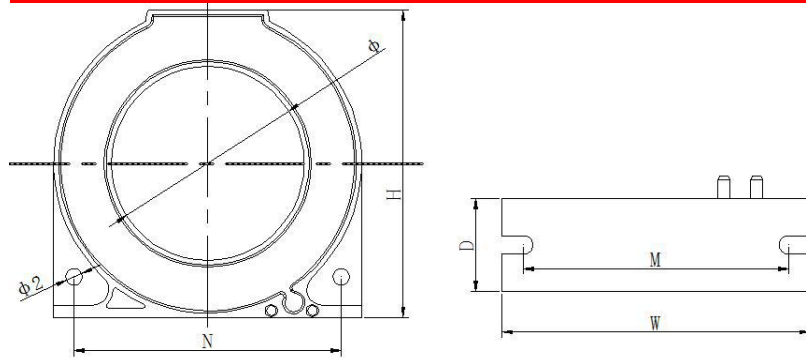

Figure 5 outline dimensions of outlay current transformer

4.6 Outline dimensions of residual current transformer



Zero sequence current transformer

Size Standard	Current specification (A)	Outline dimension(mm)			Perforation Size(mm)	Installation Size(mm)			Tolerance (mm)	Weight (g)
		W	H	D	Φ	M	N	Φ2		
L-45	16-100	75	75	22	46	65	65	4	±1	200 ± 10
L-80	100-250	120	120	23	81	105	105	4		380 ± 20
L-150	400-800	196	205	24	150	175	180	6		850 ± 50

4.7 Outline dimensions of Anti sway electric module

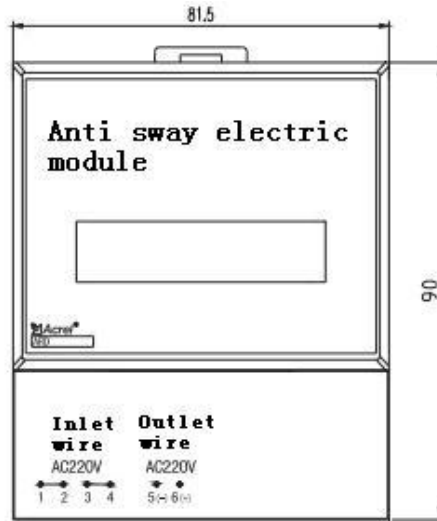

Figure 8 Outline dimensions of Anti sway electric module

4.8 Outline dimensions of AC380 power module



Figure 9 Outline dimensions of AC380 power module

5 Display and parameter setting

5.1 Operation Panel Instruction

Users can observe the running status of motor through the LED indicating lamp and LCD on display unit and start, stop, reset and set parameters through the buttons.

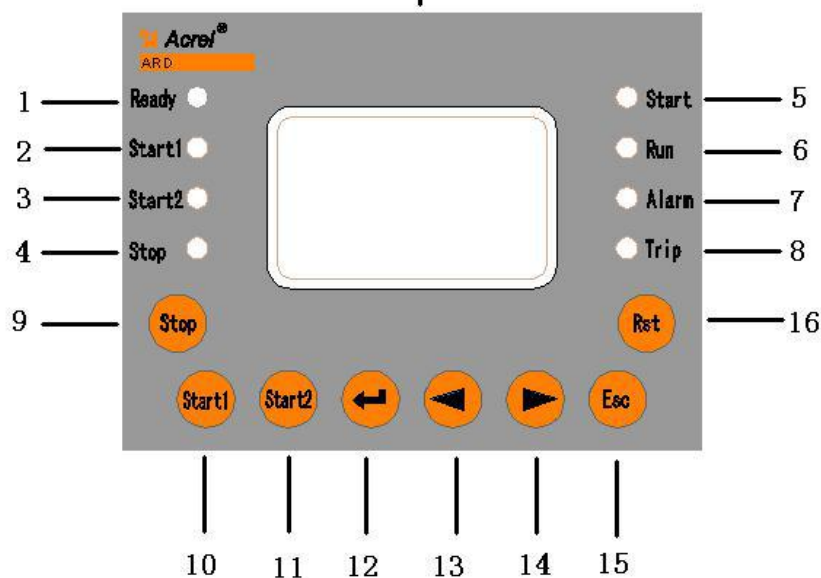

Figure 10 panel board of display module

Table 7 operation instruction









No.	Name	Status	Function Description
1	Ready LED indicating lamp	On	This indicator is on, meaning the protector is in normal state and the motor can be started.
2	Start 1 LED indicating lamp	On	This indicating lamp is on, meaning the protector starting 1 relay closed
3	Start 2 LED indicating lamp	On	This indicating lamp is on, meaning the protector starting 2 relay closed
4	Stop LED indicating lamp	On	This indicating lamp is on, meaning the motor is in stopping status.
5	Start LED indicating lamp	On	This indicating lamp is on, meaning the motor is in starting status.
6	Run LED indicating Lamp	On	This indicating lamp is on, meaning the motor is in running status.
7	Alarm LED indicating lamp	On	This indicating lamp is on, meaning the protector alarm relay has taken action.
8	Trip LED indicating lamp	On	This indicating lamp is on, meaning the protector Trip relay has taken action.
9	Stop button	Hold down	Trip starting 1, starting 2 relays
10	Start 1 button	Hold down	Operate starting 1 relay to make it closed
11	Start 2 button	Hold down	Operate starting 2 relay to make it closed
12	Confirm button	Hold down	Enter the menu and modify the parameters
13	← arrow key	Hold down	Turn on the menu; data transfer; view event log
14	→ arrow key	Hold down	Turn down menu; modify data;
15	cancel button	Hold down	Exit the menu; cancel operation; lighten backlight
16	rst button	Hold down	Reset the protector
17	LCD display screen		Display various measured parameters and setting parameters

5.2 Parameter setting

5.2.1 Display menu contents

1. A, B, C three-phase current and imbalance percentage
2. Three-phase current and the percentage of three-phase average current to the set rated current
3. U_{ab} , U_{bc} , U_{ca} line voltage
4. Active power P , apparent power S , power factor PF ;
5. I_{av} three-phase average current, U_{av} three-phase average voltage, I_d earth leakage current, frequency F ;
6. Heat capacity percentage;
7. Thermal resistance value;
8. Route 5 relay input: 1-Starting 1, 2-Starting, 2, 3-Alarm (programmable) ,4-Trip (Programmable), 5-Trip
9. Route 9 DI status.

Users can press the “” button on the display unit to display the selection of menu interface.

If users want to enter parameter setup menu, they can press the “Confirm” button when displaying the menu interface and then password input interface comes out, and users can enter the parameter setup menu after inputting the password (initial password is 0001, universal password is 0008), and users can press “” and “” button to input the correct password and then press “Confirm” button to enter parameter setup menu; and at this moment users can press “” and “” buttons to select the needed items and then press “Confirm” button to enter the setting interface and again press “” and “” buttons to select the needed sub-items , press “Confirm” key to enter the value setting interface, and then press “” and “” to set the value, after finishing setting, press “Confirm” key for save, after that, press “Cancel” button to exit or press “Cancel” button to exit without saving.

6 Wiring Mode

6.1 Auxiliary power

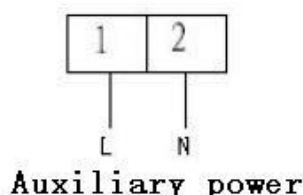

6.2 Voltage, current, zero sequence current signal input

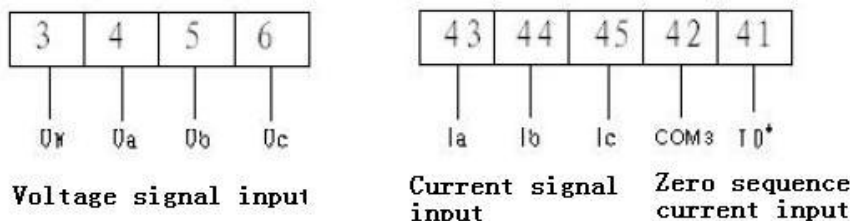

6.3 Relay output

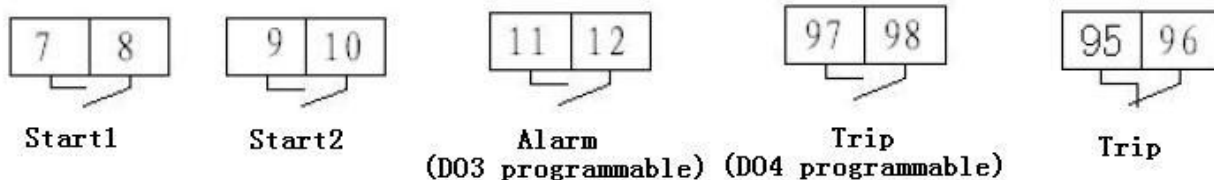

6.4 RS485 communication, DC4-20mA analog output, thermal resistance input

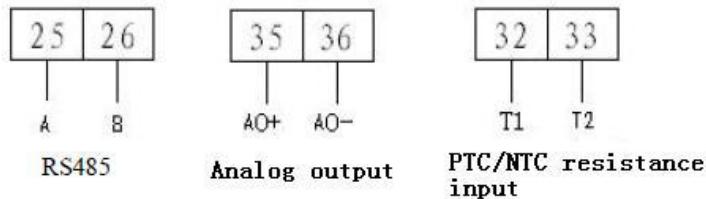

6.5 On-off input:

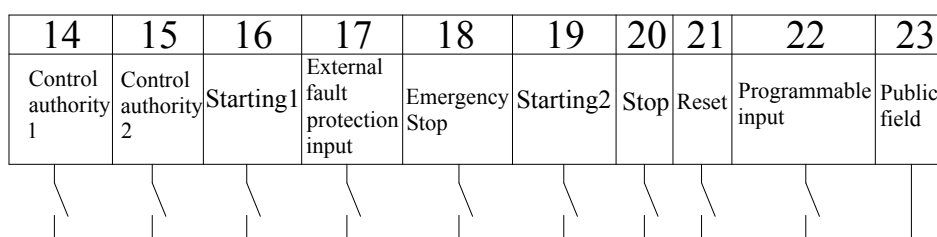

On-off input

7 Communication protocol

7.1 Address parameter

table 8 Address parameter

Address	Address	Parameters	Read-write property	Value range	Type
1	0x00	L1 phase actual current	R.	0-65535	Word
		L1 phase fundamental wave current	R.	0-65535	Word
2	0x01	L2 phase actual current	R. R.	0-65535 0-65535	Word Word
		L2 phase fundamental wave current	R.	0-65535	Word
3	0x02	L3 phase actual current	R.	0-65535	Word
		L3 phase fundamental wave current	R.	0-65535	Word
4	0x03	Earth leakage current	R.	30-100mA	Word
		Grounding current percentage	R.	1-100%	Word
5	0x04	Uab line-voltage	R.	0-999.9	Word
6	0x05	Ubc line-voltage	R.	0-999.9	Word

7	0x06	Uca line-voltage	R.	0-999.9	Word
8	0x07	Apparent power	R.	0-65535	High byte
9	0x08		R.	0-65535	Low byte
10	0x09	Active power	R.	0-65535	High byte
11	0x0A		R.	0-65535	Low byte
12	0x0B	Electric energy	R/W		High byte
13	0x0C		R/W		Low byte
14	0x0D	Power factor	R.	0-1 unit 0.001	Word
15	0x0E	Imbalance degree of current	R.	0-100%	Word
16	0x0F	Accumulated thermal capacity percentage	R.	0-100%	Word
17	0x10	Temperature value	R.	100-30000	Word
18	0x11	Motor running time of this time	R.	0-65535 hours	Word
19	0x12	Motor stopping time of this time	R.	0-65535 hours	Word
20	0x13	On-off output	R/W	Bit0-bit8 corresponding On-off input DI1-DI9, Bit11 relay1, Bit12 relay2, Bit13 relay3, Bit14 relay4, Bit15 relay5	Word
21	0x14	Trip fault indicator	R.	Bit0 overload Trip Bit1 grounding/earth leakage Trip Bit2 under load Trip Bit3 phase failure Trip Bit4 under voltage Trip Bit5 over voltage Trip Bit6 locked-rotor Trip Bit7 block Trip Bit8 imbalance Trip Bit9 PTC temperature Trip Bit10 external fault Trip Bit11 starting overtime Trip Bit12 over power Trip Bit13 under power Trip Bit14 phase sequence Trip Bit15 short circuit Trip	Word

22	0x15	Hold	R/W		Word
23	0x16	Alarm fault indicator	R.	Bit0 overload alarm Bit1 grounding/earth leakage alarm Bit2 under load alarm Bit3 phase failure alarm Bit4 under voltage alarm Bit 5over voltage alarm Bit6 locked-rotor alarm Bit7 block alarm Bit8 imbalance alarm Bit9 PTC temperature alarm Bit10 external fault alarm Bit11 starting overtime alarm Bit12 over power alarm Bit13 under power alarm Bit14 phase sequence alarm Bit15 short circuit alarm	Word
24	0x17	Hold	R/W		Word
25	0x18	Current specifications:	R.	0-1.6、 1-6.3、 2-25、 3-100、 4-250、 5-800、 6-1、 7-5	Word
		Current scaling factor	R.	10、 100	
26	0x19	A phase overload percentage	R.		Word
27	0x1A	B phase overload percentage	R.		Word
28	0x1B	C phase overload percentage	R.		Word
29	0x1C	Overload percentage	R.		Word
30	0x1D	Frequency	R.	45.0-70.0	Word
31	0x1E	Motor status;	R.	Motor thermal overload cooling remaining time	Word
				Bit0 ready; Bit1 stop; Bit2 start ,Bit3 running; Bit4 alarm; Bit5 Trip	
32 - 41	0x1F-0x28	Hold	R/W		Word
42	0x29	Operational control position	R/W	1 stop, 2 start1, 3 start 2	Word
43	0x2A	Hold	R/W		Word
44	0x2B	Factory Reset	R/W	0xFFFF	Word

45	0x2C	Total operation time	R/W	0-65535 hours	Word
46	0x2D	Total stopping time	R/W	0-65535 hours	Word
47	0x2E	Total number of starts	R/W	0-65535	Word
48	0x2F	Total Trip times	R/W	0-65535	Word
49	0x30	Year	R/W	2012-2099	Word
50	0x31	Month	R/W	1-12	Word
51	0x32	Day	R/W	1-31	
52	0x33	Hour	R/W	0-24	Word
53	0x34	Minute	R/W	0-59	Word
54	0x35	Second	R/W	0-59	Word
55-93	0x36-0x5C	Hold	R/W		Word
94	0x5D	high-speed switch	R/W	0 low speed,1 high speed	Word
95	0x5E	Transmission type set	R/W	0-Ia、1-Ib、2-Ic、3-Iav、4-Uab、5-Ubc、6-Uca、7-Uav、8-PTC、9-thermal capacity、10-P、11-F	Word
		Transmission ratio set	R/W	1-8	
96	0x5F	Residual current transformer input	R/W	0 not input,1 input	Word
97	0x60	Fundamental wave switch	R/W	1 fundamental wave,0 valid value	Word
98	0x61	Motor Type	R/W	0 general motor,1 increased safety motor	Word
99	0x62	CT ratio	R/W	1-2000	Word
100	0x63	Rated frequency	R/W	45-70	Word
101	0x64	Rated current of motor	R/W	1.6-800.0	Word
102	0x65	Rated voltage of motor	R/W	190、380、690	Word
103	0x66	Rated power of motor	R/W	High level	Word
104	0x67		R/W	Low level	Word
105	0x68	Start time setting	R/W	0.1-999.9	Word
106	0x69	Connection Mode	R/W	0 single-phase mode 1 three-phase cell line	Word

107	0x6A	Trip level setting	R/W	1、 2、 3、 5、 10、 15、 20、 25、 30、 35、 40	Word
		tE Trip time setting	R/W	2、 3、 4、 5、 6、 8、 10、 12、 15	
108	0x6B	Overload automatic reset	R/W	1 open,0 closed	
		Overload cooling time		1-255min	Word
109	0x6C	Hold	R/W		Word
110	0x6D	Trip allowable bit open/closed	R/W	Bit0 overload Trip Bit1 grounding/earth leakage Trip Bit2 under load Trip Bit3 phase failure Trip Bit4 under voltage Trip Bit5 over voltage Trip Bit6 locked-rotor Trip Bit7 block Trip Bit8 imbalance Trip Bit9 PTC temperature Trip Bit10 external fault Trip Bit11 starting overtime Trip Bit12 over power Trip Bit13 under power Trip Bit14 phase sequence Trip Bit15 short circuit Trip	Word
111	0x6E	Hold	R/W		Word
112	0x6F	Hold	R/W		Word
113	0x70	Alarm allowable bit open/closed	R/W	Bit 0 overload alarm Bit1 grounding/earth leakage alarm Bit2 under load alarm Bit3 phase failure alarm Bit4 under voltage alarm Bit 5over voltage alarm Bit6 locked-rotor alarm Bit7 block alarm Bit8 imbalance alarm Bit9 PTC temperature alarm Bit10 external fault alarm Bit11 starting overtime alarm Bit12 over power alarm Bit13 under power alarm Bit14 phase sequence alarm Bit15 short circuit	Word

114	0x71	Hold	R/W		Word
115	0x72	Hold	R/W		Word
116	0x73	Overload alarm threshold setting	R/W	1-99%	Word
117	0x74	Phase failure Trip delay setting	R/W	0.1-600	Word
118	0x75	Grounding/earth leakage alarm current setting	R/W	100-1000mA	Word
119	0x76	Grounding/earth leakage Trip current setting	R/W	100-1000mA	Word
120	0x77	Grounding/earth leakage Trip delay setting	R/W	0.1-600	Word
121	0x78	Locked-rotor alarm threshold setting	R/W	100-700%	Word
122	0x79	Locked-rotor Trip threshold setting	R/W	100-700%	Word
123	0x7A	Locked-rotor Trip delay setting	R/W	0.1-600	Word
124	0x7B	Blocking alarm threshold setting	R/W	100-700%	Word
125	0x7C	Blocking Trip threshold setting	R/W	100-700%	Word
126	0x7D	Blocking Trip delay setting	R/W	0.1-600	Word
127	0x7E	Under load alarm threshold setting	R/W	10-99%	Word
128	0x7F	Under load Trip threshold setting	R/W	10-99%	Word
129	0x80	Under load Trip delay setting	R/W	0.1-600	Word
130	0x81	Imbalance alarm threshold setting	R/W	10-80%	Word
131	0x82	Imbalance Trip threshold setting	R/W	10-80%	Word
132	0x83	Imbalance Trip delay setting	R/W	0.1-600	Word

133	0x84	NEC/PTC setting	R/W	0-NTC; 1-PTC	Word
134	0x85	Temperature alarm value setting	R/W	100-30000	Word
135	0x86	Temperature Trip value setting	R/W	100-30000	Word
136	0x87	Temperature Trip delay setting	R/W	0.1-600	Word
137	0x88	Temperature returning resistance value setting	R/W	0 closed ,1000-30000	Word
138	0x89	Under voltage alarm threshold setting	R/W	50-90%	Word
139	0x8A	Under voltage Trip threshold setting	R/W	50-90%	Word
140	0x8B	Under voltage Trip delay setting	R/W	0.1-600	Word
141	0x8C	Over voltage alarm threshold setting	R/W	110-150%	Word
142	0x8D	Over voltage Trip threshold setting	R/W	110-150%	Word
143	0x8E	Over voltage Trip delay setting	R/W	0.1-600	Word
144	0x8F	Over power alarm threshold setting	R/W	100-700%	Word
145	0x90	Over power Trip threshold setting	R/W	100-700%	Word
146	0x91	Over power Trip delay	R/W	0.1-600	Word
147	0x92	Under power alarm threshold setting	R/W	0-100%	Word
148	0x93	Under power Trip threshold setting	R/W	0-100%	Word
149	0x94	Under power Trip delay	R/W	0.1-600	Word
150	0x95	Short circuit alarm threshold setting	R/W	400%-700% maximum measurable overload times	Word
151	0x96	Short circuit Trip threshold setting	R/W	400%-700% maximum measurable overload times	Word
152	0x97	Short circuit Trip delay	R/W	0.1-600	Word

153	0x98	Phase sequence fault delay setting	R/W	0.1-600	Word
154	0x99	External fault Trip delay setting	R/W	0.1-600	Word
155	0x9A	Grounding alarm percentage setting	R/W	20-100%	Word
156	0x9B	Grounding Trip percentage setting	R/W	20-100%	Word
157	0x9C	Grounding Trip delay setting	R/W	0.1-600	Word
158	0x9D	Reflux detection delay setting	R/W	0.1-600	Word
159	0x9E	Reflux detection control	R/W	0 closed 1 open	Word
160	0x9F	Remote resetting	R/W	Normal 0; remote reset 1	Word
161	0xA0	Contact allowed breaking current	R/W	0, OFF, 600-1000%	Word
162	0xA1	Self-start Mode	R/W	0 start; 1 recover	Word
163	0xA2	Self-starting delay setting	R/W	0.1-600	Word
164	0xA3	Self-start control	R/W	0 closed	Word
165	0xA4	Restarting voltage setting	R/W	75-95%	Word
166	0xA5	Immediate restarting allowed power failure time	R/W	0.1-0.5	Word
167	0xA6	Delay restarting allowed power failure time	R/W	0.5-10.0	Word
168	0xA7	Restarting delay setting	R/W	1.0-6008	Word
169	0xA8	Loss voltage restarting control	R/W	0 closed, 1=starting 1 after restarting, 2=starting 2 after starting	Word
170	0xA9	Parity bit	R/W	0 no parity check	Word
171	0xAA	MODBUS baud rate setting	R/W	1200、2400、4800、9600、19200、38400	Word
172	0xAB	MODBUS address setting	R/W	1-247	Word
173-178	0xAC-0xB1	Hold	R/W		Word

179	0xB2	Starting control setting	R/W	0=protection mode, 1>manual mode ,2=two-step starting, 3=two-speed mode	Word
180	0xB3	Control authority setting	R/W	0 local, 1 on-site, 2 remote, 3 one in three, 4 all control	Word
181	0xB4	Starting delay setting	R/W	0.1-600	Word
182-190	0xB5-0xBD	Hold	R/W		Word
191	0xBE	Relay initial status	R/W	0 open 1 closed, bit0-4: relay 1-5	Word
192	0xBF	Relay 1 operation setting	R/W	0 electrical level 3-250 unit 0.1s	Word
193	0xC0	Relay 2 operation setting	R/W	0 electrical level 3-250 unit 0.1s	Word
194	0xC1	Relay 3 operation setting	R/W	0 electrical level 3-250 unit 0.1s	Word
195	0xC2	Relay 4 operation setting	R/W	0 electrical level 3-250 unit 0.1s	Word
196	0xC3	Relay 5 operation setting	R/W	0 electrical level 3-250 unit 0.1s	Word
197	0xC4	Definition of programmable output 1	R/W	Alarm fault: corresponding to alarm allowable position	Word
198	0xC5		R/W	Trip fault: corresponding Trip allowable position	Word
199	0xC6		R/W	Other functions: 2-starting2 、 3-alarm fault output, 4-Trip fault output, 5-device self-checking output, 6-device power output, 7-stopping status ready, 8-running status output, 9-controlling output, 10-bus control	Word
200	0xC7	Definition of programmable output 2	R/W	Alarm fault: corresponding alarm allowable position	Word
201	0xC8		R/W	Trip fault: corresponding Trip allowable position	Word

202	0xC9		R/W	Other functions: 1-start1 、 2-start2 、 3-alarm fault output, 4-Trip fault output, 5-device self-checking output, 6-device power output, 7-stopping status ready, 8-running status output, 9-DI controlling output, 10-bus control	Word
203	0xCA	Definition of programmable output 3	R/W	Alarm fault: corresponding alarm allowable position	Word
204	0xCB		R/W	Trip fault: corresponding Trip allowable position	Word
205	0xCC		R/W	Other functions: 1-starting 1 、 2-starting 2,3-alarm fault output, 4-Trip fault output, 5-device self-checking output, 6-device power output, 7-stopping status ready, 8-running status output, 9-DI controlling output, 10-bus control	Word
206	0xCD	D11 programmable definition	R/W	1 normal DI,2 starting 1 (direct starting, turn left, low speed), 3 Starting 2 (turn right, high speed), 4 stopping, 5 reset, 6 emergency stop, 7 external fault, 8 starting/stopping, 9 control authority 1, 10 control authority 11 DO control	Word
207	0xCE	D12 programmable definition	R/W	-Ditto-	Word
208	0xCF	D13 programmable definition	R/W	-Ditto-	Word
209	0xD0	D14 programmable definition	R/W	-Ditto-	Word
210	0xD1	D15 programmable definition	R/W	-Ditto-	Word
211	0xD2	D16 programmable definition	RIW	-Ditto-	Word
212	0xD3	D17 programmable definition	RIW	-Ditto-	Word
213	0xD4	D18 programmable definition	RIW	-Ditto-	Word

214	0xD5	D19 programmable definition	RIW		-Ditto-	Word		
215-253	0xD6-0XFC	Hold	RIW			Word		
254	0xFD	Software version number	RIW		1.0-9.9	Word		
255	0xFE	Hold				Word		
256	0xFF	Hold				Word		
257	0x0100	Event control parameter	R.		Event switch 0 closed 1 open	Word		
258	0x0101	Incident record	STA1	R.	Protection 1 action pattern 1 overload Trip 2 grounding/earth leakage Trip 3 under load Trip 4 phase failure Trip 5 under voltage Trip 6 over voltage Trip 7 locked-rotor Trip 8 blocking Trip 9 imbalance Trip 10 temperature Trip 11 external fault Trip 12 starting overtime Trip 13 over power Trip 14 under power Trip 15 phase sequence Trip 16 short circuit Trip	High byte		
					Month1	R.	Operation 1 time-month	Low
					Day1	R.	Operation 1 time-date	High
					Hour1	R.	Operation 1 time-hour	Low
					Minute1	R.	Operation 1 time-minute	High
259	0x0102		Second1	R.	Operation 1 time-second	Low		
260	0x0103							
261-317	0x0104-0x013C	Incident record 2-20				57Word		

7.2 Profibus_DP

table 9 Input data bit 31 characters (ARD-DP Master station)

Address	Address	Parameters	Read-write	Value range	Type
1	0x00	L1 phase actual current	R.	0-65535	Word
		L1 phase fundamental wave current	R.	0-65535	Word
2	0x01	L2 phase actual current	R.	0-65535	Word
		L2 phase fundamental wave current	R.	0-65535	Word
3	0x02	L3 phase fundamental wave current	R.	0-65535	Word
		L3 phase fundamental wave current	R.	0-65535	Word
4	0x03	Earth leakage current	R.	30-1000mA	
		Grounding current percentage	R.	0-100%	Word
5	0x04	Uab line-voltage	R.	0-999.9	Word
6	0x05	Ubc line-voltage	R.	0-999.9	Word
7	0x06	Uca line-voltage	R.	0-999.9	Word
8	0x07	Apparent power	R.	0-65535	High byte
9	0x08		R.	0-65535	Low byte
10	0x09	Active power	R.	0-65535	High byte
11	0x0A		R.	0-65535	Low byte
12	0x0B	Electric energy	R.	0-65535	High byte
13	0x0C		R.	0-65535	Low byte
14	0x0D	Power factor	R.	0-1 unit 0.001	Word
15	0x0E	Imbalance degree of current	R.	0-100%	
16	0x0F	Accumulated thermal capacity percentage	R.	0-100%	Word

17	0x10	Temperature value	R.	100-30000	Word
18	0x11	Motor running time of this time	R.	0-65535 hours	Word
19	0x12	Motor stopping time of this time	R.	0-65535 hours	Word
20	0x13	On-off output	R.	Bit0-Bit8 corresponding on-off input DI1-DI9, Bit11 relay 1, Bit12 relay 2, Bits 13 relay 3, Bit14 relay 4, Bit 15 relay 5	Word
21	0x14	Trip fault indicator	R.	Bit0 overload Trip Bit1 grounding/earth leakage Trip Bit2 under load Trip Bit3 phase failure Trip Bit4 under voltage Trip Bit5 over voltage Trip Bit6 locked-rotor Trip Bit7 blocking Trip Bit8 imbalance Trip Bit9 PTC temperature Trip Bit10 external fault Trip Bit11 starting overtime Trip Bit12 over power Trip Bit13 under power Trip Bit14 phase sequence Trip Bit15 short circuit Trip	Word
22	0x15	Hold	R/W		Word
23	0x16	Alarm fault indicator	R.	Bit0 overload alarm Bit1 grounding/earth leakage alarm Bit2 under load alarm Bit3 phase failure alarm Bit4 under voltage alarm Bit5 over voltage alarm Bit6 locked-rotor alarm Bit7 block alarm Bit8 imbalance alarm Bit9 PTC temperature alarm Bit10 external fault alarm Bit11 starting overtime alarm Bit12 over power alarm Bit13 under power alarm Bit14 phase sequence alarm Bit15 short circuit alarm	Word
24	0x17	Hold	R/W		Word

25	0x18	Current specifications:	R.	0-1. 6、1-6.3、2-25、3-100、4-250、5-800、6-1、7-5	Word
		Current scaling factor	R.	10、100	
26	0x19	A phase overload	R.		Word
27	0x1A	B phase overload percentage	R.		Word
28	0x1B	C phase overload percentage	R.		Word
29	0x1C	Overload percentage	R.		Word
30	0x1D	Frequency	R.	45.0-70.0	Word
31	0x1E	Motor status;	R.	Motor thermal overload cooling remaining time	Word
				Bit0 ready; Bit1 stop; Bit2 start; Bit3 running; Bit4 alarm; Bit5 Trip	

Note:

high byte ahead, low byte behind, such as [0][1], [0] is high 8-bit, and [1] is low 8-bit, other analogy. Output parameter 1 character DP master station-ARD)

This can be displayed specifically as follows:

Output	Parameters	Value range	Remarks
[00][01]	Control Word	Bit0: stopping Bit1: starting 1 Bit2: starting 2 Bit3: remote resetting Bit4: relay 3	0: closed 1: breakover
		Bit15: output data enable bit	When this bit is 1, all operations of Bit0-Bit4 are valid, When it is 0, operations are invalid.

Profibus output data (control data), for example, if motor is remotely started, starting mode is selected as “Starting 1”, and output data: 0x8002 (hexadecimal number).

7.3 DeviceNet

Input data bit 14 characters (ARD-DeviceNet Master station)

Address	Address	Parameters	Read-write property	Value range	Type	Remarks
1	[00][01]	Actual current of phase L1	R	0-65535	word	
2	[02][03]	Actual current of phase L2	R	0-65535	word	
3	[04][05]	Actual current of phase L3	R	0-65535	word	

4	[06][07]	Leakage current	R	0-1000mA	word	
		Percentage of earthing current	R	0-100%		
5	[08][09]	Uab-Line voltage	R	0~999.9	word	
6	[0A][0B]	Uab-Line voltage	R	0~999.9	word	
7	[0C][0D]	Uab-Line voltage	R	0~999.9	word	
8	[0E][0F]	Electric energy	R	0-65535	word	High 16-bit electric energy
9	[10][11]		R	0-65535	word	Low 16-bit electric energy
10	[12][13]	Switch output	R	Bit0-bit8 corresponding switching input DI1-DI9, Bit11 relay1, Bit12 relay 2, Bit13 relay 3, Bit14 relay 4, Bit15 relay 5	word	
11	[14][15]	Trip fault indicator	R	Bit0 overload trip Bit1 earthing/earth leakage trip Bit2 under load trip Bit3 phase failure trip Bit4 under voltage trip Bit5 over voltage trip Bit6 locked-rotor trip Bit7 blocking trip Bit8 imbalance trip Bit9 PTC temperature trip Bit10 external fault trip Bit11 starting overtime trip Bit12 over power trip Bit13 under power trip Bit14 phase sequence trip Bit15 short circuit trip	word	
12	[16][17]	Alarm fault indicator	R	Bit0 overload alarm Bit1 earthing/earth leakage alarm Bit2 under load alarm Bit3 phase failure alarm Bit4 under voltage alarm Bit5 over voltage alarm Bit6 locked-rotor alarm Bit7 block alarm Bit8 unbalance alarm Bit9 PTC temperature alarm Bit10 external fault alarm	word	

				Bit11 starting overtime alarm Bit12 over power alarm Bit13 under power alarm Bit14 phase sequence alarm Bit15 short circuit alarm		
13	[18][19]	Current specifications Current scaling factor	R	0-1. 6、1-6.3、2-25、3-100、 4-250、5-800、6-1、7-5 10、100	word	High 8-bit is current specifications ,low 8-bit is current scaling factor
14	[1A][1B]	Motor status	R	Motor thermal overload cooling remaining time Bit0 ready; Bit1 stop; Bit2 start; Bit3 running; Bit4 alarm; Bit5 trip;	word	High 8-bit is motor thermal overload cooling remaining time, low 8-bit is motor operation

Note: For every word type datum, high byte is ahead, low byte behind, such as 0 x [0][1], [0]is high 8-bit, and [1] is low 8-bit. And one more note is that the word data seen from the DevieNet Master Station shows that low byte comes before the high byte. For example, 0x[00][01] would be shown as 0x[01][00].

Output parameter (1 character, 2 character, DeviceNet Master Station→ARD)

Address	Address	Parameters	Value range	Type	Remarks
1	[00][01]	Control Word	Bit0: stopping Bit1: starting 1 Bit2: starting 2 Bit 3:remote resetting Bit4: relay 3	word	0: closed 1: breakover
			Bit15: output data enable bit		When this bit is 1, all operations of Bit0-Bit4 are valid, When it is 0, operations are invalid.

Note: An example for DeviceNet ouput data: if it is remotely started, starting mode is selected as “Starting 1”, and output data: 02 80 (hexadecimal number). While writing word date at DeviceNet Master Station, high byte shall be after low byte. It is not allowed to send two same orders in succession.

8 Typical application solutions

ARD3 motor protector protected mode wiring diagram

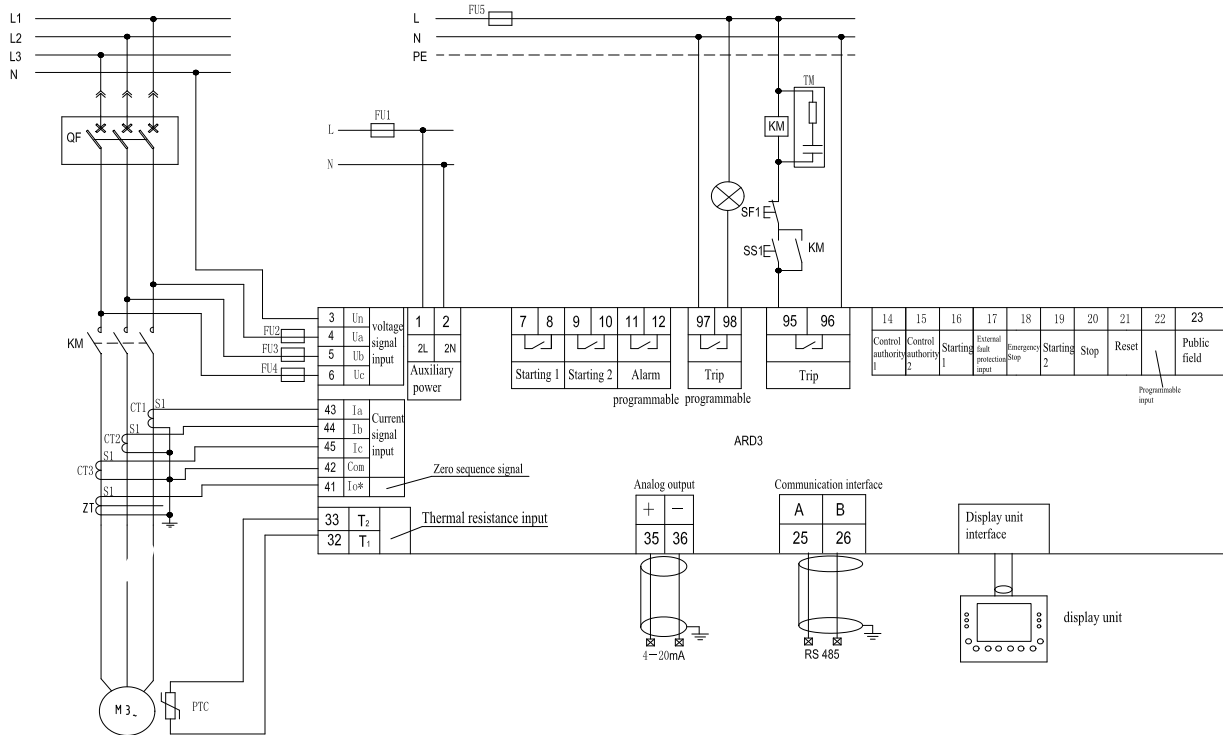

Protected mode: the starting or stopping of motor is controlled by external button, the magnetizing coil of contactor KM connects with the normally closed contact of the Trip relay using series connection. Close QA, press starting button SF, the magnetizing coil of KM is energized and close the main contactor, then the motor starts; when press stopping button SS, the magnetizing coil of KM is loss of power and Trips the main contact, the motor stops.

Notes: 1. Trip (DO4 programmable) relay can be used for output to realize the quick-break function of moulded case circuit breaker.

2. Programmable relay can be defined as starting 1, starting 2, alarm fault output, Trip fault output, device self-checking output, device power output, stopping status ready, running status output, DI controlling output, bus control.

ARD3 motor protector direct starting mode wiring diagram

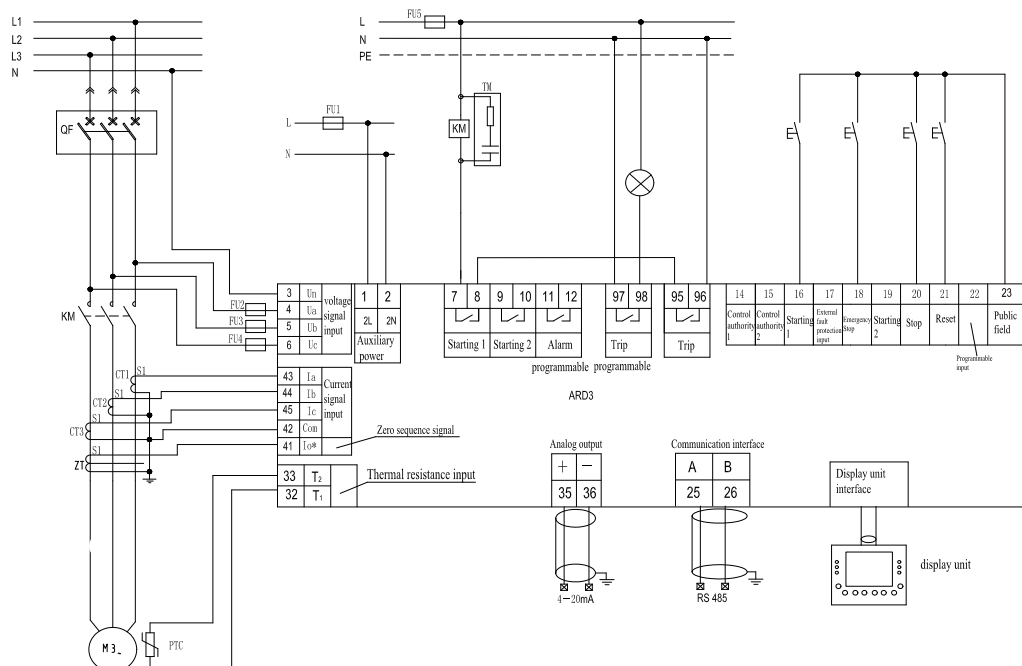

Direct starting :the starting or stopping of motor is controlled by protector, the magnetizing coil of contactor KM connects with the normally closed contact of the Trip relay and normally open contact of starting 1 relay using series connection, close QA, press “Starting I” button on the display unit (staring control is set to manual mode, enable On-site control) to close the main contactor of KM, then the motor starts; when pressing “stopping” button, the magnetizing coil of KM is loss of power and Trips the main contactor, the motor stops.

Control authority selection (except protection mode): 90FL display unit button On-site control, DI terminal on-site control, PC communication remote control. DI6 and DI7 are combined to achieve three-position authority selection. In the table below, “0” means the contol authority is not connected, “1” means connected.

Table 10 DI control authority definition

On-off input	DI input status	
	DI1 control authority 1	DI2 control authority 2
On-site control	1	0
Remote control	0	0
On-sit control	0	1

ARD3 motor protector Y- Δ starting mode wiring diagram

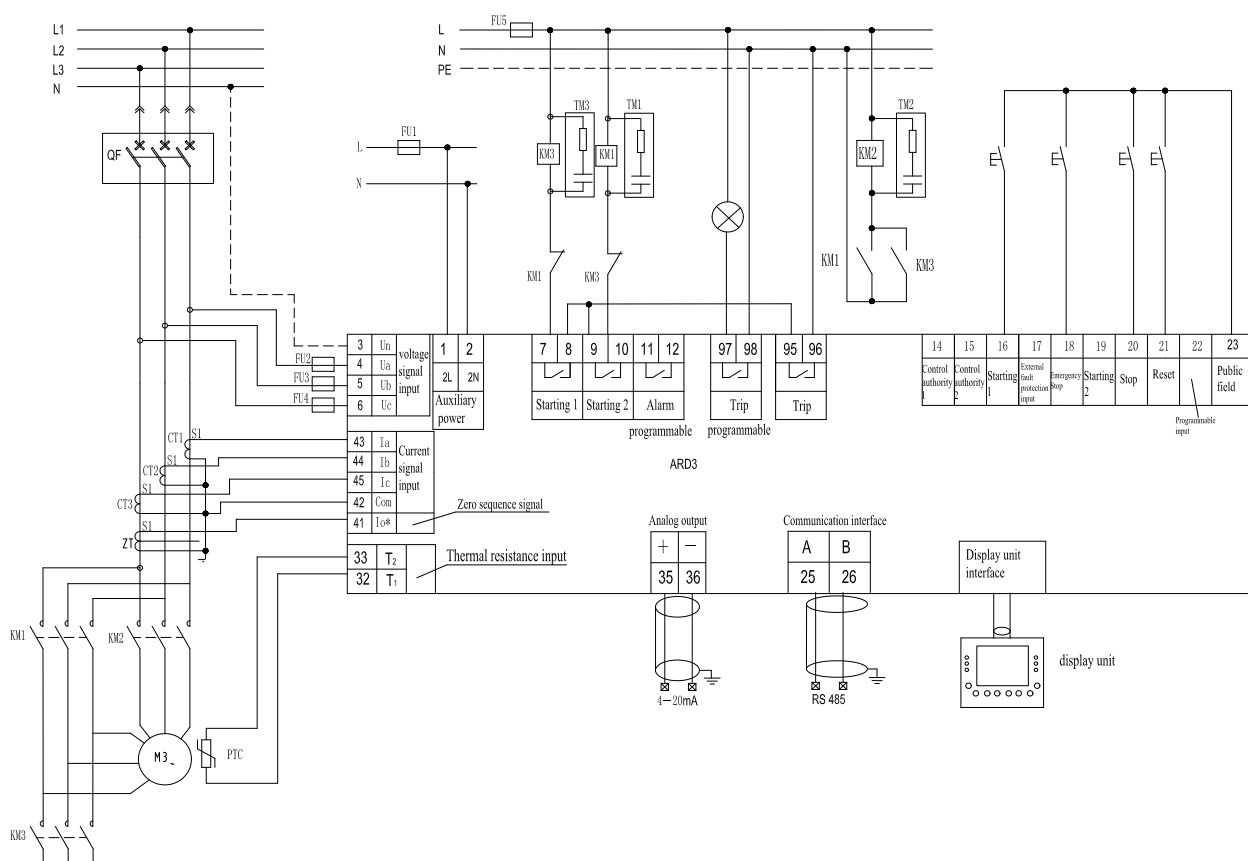

Y- Δstarting: motor starting and stopping are controlled by the protector. "According to the method illustrated, after the control circuit is connected, and then close QA, press the "start I" " button on display unit, (starting control is set to start in two steps to enable On-site control), enable the starter relay 1 to close, KML KM3 attract coil to energize, and main

contactor of KML KM3 to close. The motor is started by Y way, when reaches conversion time, the protector will automatically disconnect starter relay 1, while close the starter relay 2. KM2, KM3 attract coil is energized, and close main contactor of KM2, KM3; the protector turns into A running, press the "" stop "" button, and the motor will stop working."

9 settings and instructions of protection function

Parameter setting :

table 11 Parameter setting

No.	Main menu	Function	Sort	Setting ranges	Default value	Unit
1	Alarm information					
2	Trip Information					
3	Operation Information	1 this run				h
		2 this stopping				h
		3 Running Time				h
		4 stopping time				h
		5 number of starts				
		6 Number of Trips				
4	system parameter	1 Baud rate		2400、4800、9600、19200、38400	9600	bps
		2 Postal address		1-247		
		3 password		0-9999		
		4 Motor Type		General motor, safety-increased motor	Common motor	
		5 Transmission Type		la, Ib, Ie, lay, Uab, Ubc, Uca, Uay, PTC, heat Capacity, P, F	lay	
		6 transmission ratio		1-8	2	
		7 backlight lit		On/off	OFF	
		8 System voltage		380、660	380	V
		9 Rated frequency		45-65	50	
		10 Rated power		0.4-1.6	1056、	
	1.6-6.3		4158、			

				6.3-25	16500、	w
				25-100	66000、	
				63-250	165000、	
				250-800	480000	
		11.CT ratio		1-1000	1	
		12 local speed switch		On/off	OFF	
		13.fundamental wave switch		On/off	OFF	
		14.Software Version No.				
5	Protection parameter	1. starting protection	Starting time	0.1-999.9	10.0	s
			Alarm	On/off	OFF	
			Trip	On/off	ON	
		2 overload protection	Rated current of motor	0.1-1.6	1.6	A
				1.6-6.3	6.3	
				6.3-25	25.0	
				25-100	100	
				63-250	250	
				250-800	800	
			Trip class	1, 2,3,5,10,15,20 25、 30、 35、 40	5	Level
				2、 3、 4、 5、 6、 8、 10、 12、 15	2	
		Alarm threshold value	1-99%	85	%	
		Alarm	On/off	OFF		
		Trip	On/off	ON		
		Overload automatic reset	On/off	OFF		
Cooling time	1-30	30	min			
3 under load protection	Alarm threshold value	10-99%	70	%		
	Trip threshold value	10-99%	50	%		
	Trip delay	0.1-600	5.0	s		

		Alarm	On/off	OFF	
		Trip	On/off	OFF	
	4 Phase failure protection	Trip delay	0.1-600	1.0	s
		Alarm	On/off	OFF	
		Trip	On/off	ON	
	5 phase sequence protection	Trip delay	0.1-600	1.0	s
		Alarm	On/off	OFF	
		Trip	On/off	ON	
	6 imbalance protection	Alarm threshold value	10-80%	20	%
		Trip threshold value	10-80%	30	%
		Trip delay	0.1-600	5.0	s
		Alarm	On/off	OFF	
		Trip	On/off	OFF	
	7 Grounding / Earth leakage	Transformer input	On/off	OFF	
		Grounding alarm threshold value	20-100%	20	%
		Grounding Trip threshold value	20-100%	50	%
		Trip delay	0.1-600	0.1	s
		Earth leakage alarm current	100-1000	200	mA
		Earth leakage Trip current	100-1000	300	mA
		Trip delay	0.1-600	0.5	s
		Alarm	On/off	OFF	
		Trip	On/off	OFF	
	8 Short-Circuit Protection	Alarm threshold value	400-700% max. overload measurable	400	%
		Trip threshold value	400-700% max. overload measurable	500	%

			Trip delay	0.1-600	0.1	s
			Alarm	On/off	OFF	
			Trip	On/off	OFF	
		9 Over voltage protection	Alarm threshold value	110-150%	110	%
			Trip threshold value	110-150%	120	%
			Trip delay	0.1-600	5.0	s
			Alarm	On/off	OFF	
			Trip	On/off	OFF	
		10 Under voltage protection	Alarm threshold value	55-90%	90	%
			Trip threshold value	55-90%	80	%
			Trip delay	0.1-600	5.0	s
			Alarm	On/off	OFF	
			Trip	On/off	OFF	
		11 lock-rotor protection	Alarm threshold value	100-700%	500	%
			Trip threshold value	100-700%	600	%
			Trip delay	0.1-600	5.0	s
			Alarm	On/off	OFF	
			Trip	On/off	OFF	
		12 blocking protection	Alarm threshold value	100-700%	150	%
			Trip threshold value	100-700%	250	%
			Trip delay	0.1-600	5.0	s

			Alarm	On/off	OFF			
			Trip	On/off	OFF			
		13 overpower protection	Alarm threshold value	100-700%	150	%		
			Trip threshold value	100-700%	250	%		
			Trip delay	0.1-600	5.0	s		
			Alarm	On/off	OFF			
			Trip	On/off	OFF			
		14 under power protection	Alarm threshold value	0-100%	80	%		
			Trip threshold value	0-100%	50	%		
			Trip delay	0.1-600	5.0	s		
			Alarm	On/off	OFF			
			Trip	On/off	OFF			
		15 temperature protection	PTC type	On/off	ON			
			Return resistance value	0 closed 1000-30000	0	Ω		
			Alarm resistance value	100-30000	1600	Ω		
			Trip resistance value	100-30000	3600	Ω		
			Trip delay	0.1-600	5.0	s		
			Alarm	On/off	OFF			
			Trip	On/off	OFF			
		16 External fault	Trip delay	0.1-600	5.0	s		
			Alarm	On/off	OFF			
			Trip	On/off	OFF			
		6	Control parameter	1 control authority	On-off input	local, on-site, remote , Full-controlled	Full-controlled	

		2 Starting Control.	Starting Mode	Protection mode, manual mode, two-step Mode, two-speed mode	protection mode		
		3 self-start	Starting - delay	0.1-600	3.0	s	
			Self-start Mode	reset/ start	Starting		
			Self-start delay	0.1-600	5.0	s	
			Self-start control	On/off	OFF		
		4 Loss voltage restarting	voltage setting	75-95%	80	%	
			Immediately restarting power failure time	0.1-0.5	0.1	s	
			Allowable time (min)	0.5-10.0	5.0	s	
			Restarting delay	1.0-60.08	30.0	s	
			Controls	0 OFF, 1 start 1, 2 start2	OFF		
		5 reflow inspection	Delay setting	0.1-600		s	
			Controls	On/off	OFF		
		6 Programmable Setting	DO3 Programmable setting	1 - Start 1, 2 - Start 3 - alarm fault output, 4 - Trip fault output, 5 - device self-checking output 6 - device power output, 7 - stopping state ready 8 - running state output, 9-DI control output, 10 - Bus control	3		
				Action time setting	0-250	0.1	s

		7 programmable Programmable Setting	DO4	Programmable setting setting	1 - Start ing1, 2 - Start 2, 3 - alarm fault output, 4 - Trip fault output, 5 - device self-checking output 6 - device power output, 7 - stopping state ready 8 - running state output, 9-DI control output, 10 - Bus control	3		
					Action time	0-250	0.1	s
					Trip setting	0-65535	65535	
		8 programmable Setting	DI9	DI9 programmable setting	1 common DI 2 Start 1 (direct start, turn left, low speed 3 start 2 (turn right, high speed), 4 Stop 5 Resetting, 6 Emergency Stop 7 external fault 8 start / stop, 9 control authority 1 10 control authority 2 11 two-wire start-stop	1		
					DO2	On/off	OFF	
					DO3	On/off	OFF	
					DO4	On/off	OFF	
		9 TEST			DO5	On/off	OFF	

9.2 Function instructions

Table 12 Each type of protection work periods :

Protection class:	Work periods
Phase sequence, external fault, over voltage, under-voltage	Stop
Phase sequence, external fault, over voltage, under-voltage, phase failure, earth leakage/grounding, locked- rotor, starting overtime	Starting

Phase sequence, external fault, over voltage, under-voltage, phase failure, earth leakage and grounding, overload, unbalance, blocking, under load, under power, over power, temperature, short circuit	Run
---	-----

■ Starting overtime protection

While the motor starting time reaches, and the motor round current detected by protection still more than 110%Ie, the protection will start. Refers to increased safety motor, the starting time do not set more than t_r 1.7 times.

■ Overload Protection

When the motor is running in the situation of overload, its current is over rated for a long time. The motor will overheat and burn down, as the insulation property decreased. The protection computes the heat capacity of motor according to the heat generation characteristics of motor, simulates heat generation characteristics of motor to protect the motor.

■ Overload protection current-time comparison show in table 10, overload characteristic curves (K curves) show in picture 11.

Table 13 overload protection current-time table

Optional tripping curves level K	5	10	15	20	25	30	35	40
Error of tripping delay(S) $\pm 10\%$	Three-phase balance load, begin from the cold state							
$\times 1.2$ Rated value Ie	125	250	375	500	625	750	875	1000
$\times 1.5$	80	160	240	320	400	480	560	640
$\times 2$	45	90	135	180	225	270	315	360
$\times 3$	20	40	60	80	100	120	140	160
$\times 4$	11.3	22.5	33.8	45	56.3	67.5	78.8	90
$\times 5$	7.2	14.4	21.6	28.8	36	43.2	50.4	57.6
$\times 6$	5	10	15	20	25	30	35	40
$\times 7.2$	3.5	6.9	10.4	13.9	17.4	20.8	24.3	27.8
$\times 8$	2.8	5.6	8.4	11.3	14.1	16.9	19.7	22.5

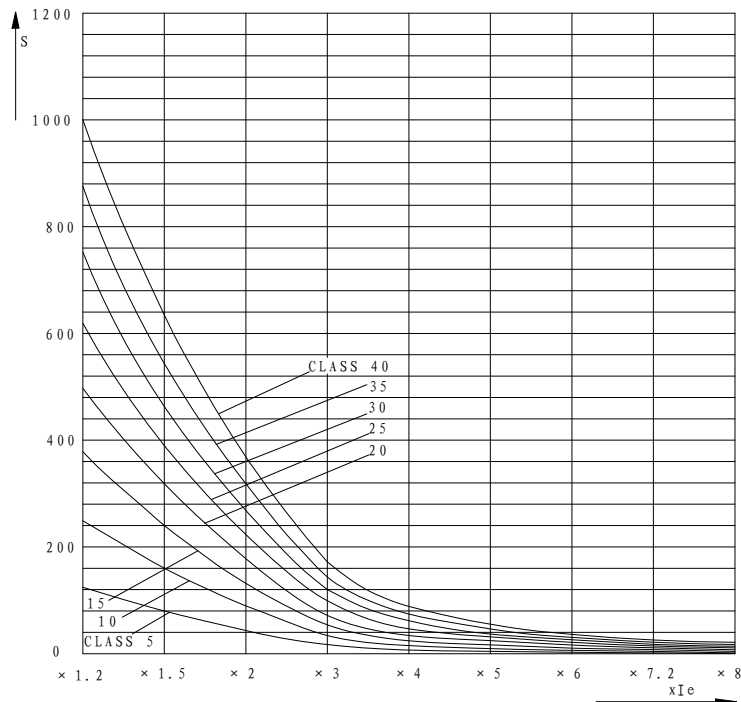

Figure 11 overload characteristic curves graph

Under load Protection

When the load carried by motor is the pump-load, no load or underload will damage the motor, the protection provides underload protection. When the ratio of the average 3 phase current and rated current is lower than set value, the protection should trip or alarm in tripping(delay) set time.

(Reference ARD2 Function instructions)

Phase failure protection or imbalance protection

Running in the condition of phrase failure or 3 phase current unbalance make great harm to motor, when phase failure occurs or 3 phase current unbalance, the imbalance ratio reaches the protective set value, the protection will send a alarm or tripping signal in accordance with internal set to make the motor safely.

t_E time protection (suitable for safety-increased motor)

After the AC winding reaches the rated operation stable temperature at maximum ambient temperature for safety-increased motors, the desired time from the beginning of locked-rotor current to the time rising to limiting temperature is t_E. The t_E time of safety-increased motors is usually provided by the motor manufacturers, and users can find the data on the motor nameplate.

When providing locked-rotor and within the t_E time, disconnect the thermal overload protection of electric motor, only after the motor starting is completed, the independent delay timer can be applied.

Delay timer with independence。 t_E protection characteristic curve action delay table shown in Table 22, and curve diagram as shown below.

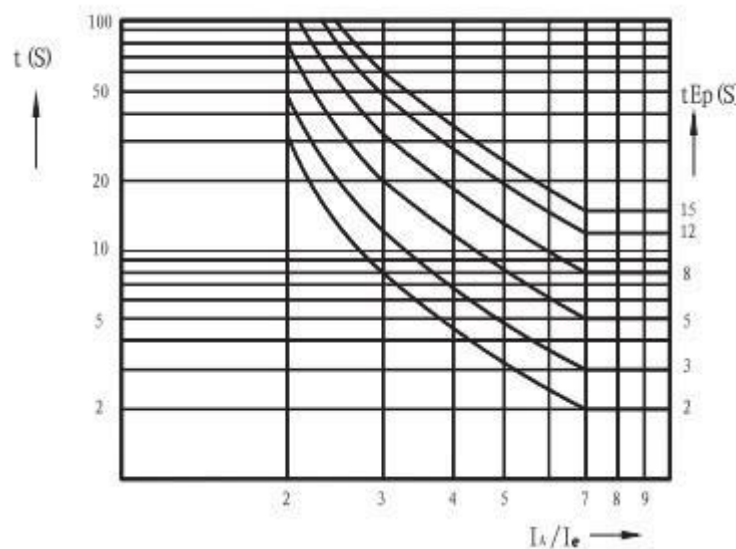

t_E protection delay and locked-rotor current ratio IA/IE's current-time characteristic curve

t_{Ep}: Allow locked-rotor time when under 7 times rated current; IA: locked-rotor current; IE: rated current of motor.

Table 14 Action Delay Characteristics Table

tEp set Set IA/IE	2	3	4	5	6	8	10	12	15
2.0	32	48	64	80	96	128	160	192	240
2.2	20.27	30.4	40.54	50.67	60.81	81.08	101.35	121.62	152.02
2.4	14.75	22.12	29.5	36.87	44.25	59	73.75	88.5	110.63
2.6	11.54	17.32	23.09	28.87	34.64	46.19	57.74	69.29	86.62
2.8	9.46	14.19	18.92	23.65	28.39	37.85	43.31	56.78	70.97
3.00	8	12	16	20	24	32	40	48	60
3.20	6.91	10.37	13.83	17.29	20.75	27.67	34.59	41.51	51.88

3.40	6.08	9.13	12.17	15.22	18.26	24.35	30.44	36.52	45.66
3.60	5.43	8.14	10.86	13.58	16.29	21.72	27.16	32.59	40.74
3.80	4.9	7.35	9.8	12.25	14.7	19.6	24.5	29.41	36.76
4.00	4.46	6.69	8.93	11.16	13.39	17.86	22.32	26.79	33.48
4.20	4.09	6.14	8.19	10.24	12.29	16.39	20.49	24.59	30.74
4.40	3.79	5.68	7.58	9.47	11.37	15.06	18.95	22.74	28.42
4.60	3.52	5.28	7.05	8.81	10.57	14.1	17.62	21.15	26.43
4.80	3.29	4.94	6.59	8.24	9.88	13.08	16.48	19.77	24.72
5.00	3.09	4.64	6.19	7.74	9.29	12.38	15.48	18.58	23.22
5.20	2.92	4.38	5.84	7.3	8.76	11.68	14.6	17.53	21.91
5.40	2.76	4.15	5.53	6.91	8.3	11.07	13.83	16.6	20.75
5.60	2.63	3.94	5.26	6.57	7.89	10.52	13.15	15.78	19.73
5.80	2.5	3.76	5.01	6.27	7.52	10.03	12.54	15.05	18.81
6.00	2.4	3.6	4.8	6	7.2	9.6	12	14.4	18
6.20	2.3	3.45	4.6	5.75	6.9	9.2	11.51	13.81	17.26
6.40	2.21	3.32	4.42	5.53	6.64	8.85	11.07	13.28	16.6
6.60	2.13	3.2	4.27	5.33	6.4	8.54	10.67	12.81	16.01
6.80	2.06	3.09	4.12	5.16	6.19	8.25	10.32	12.38	15.48
7.00	2	3	4	5	6	8	10	12	15
8.00	2	3	4	5	6	8	10	12	15
9.00	0.2	0.2	0.2	0.2	0.2	0.2	0.2	0.2	0.2

Note: (a) t_E protection time = operation time $12 \times t_{Ep}$ setting when E_p is 2 (S) :

(b) when t_E is set to 5 (S), t_E value by starting current ratio $I_{AI} I_e$ is determined according to IEC79-7, GB3836.3-2000 standard, when apply to safety-increased motor t_E protection, its inverse time overload may refer to characteristic curve settings. To ensure that the power is turned off before the time when the motor companying rotating, the inverse time curve of overload protection should be down about 15%.

(c) The action time of " t_E protection is achieved by setting "Motor Type" and " Trip class" according to Table 9 ". t_{Ep} (Trip class) selects the appropriate Trip curves. "(When the motor type is selected to "safety-increased motors", the "Trip class will automatically become t_{Ep} setting: Otherwise, the Trip curve is inverse time overload Trip curve of normal motor."

■ phase sequence protection

When the protector detects the error of voltage phase sequence of the motor, the locking motor will start to protect the motor safety.

■ Grounding/ Earth leakage Protection

ARD3 has the function of grounding and leakage protection, but user can only choose one kind. Grounding protection calculate residual current automatically, do not need external transformer, used for short-circuit protection about motor metal case. By increasing the leakage transformer, leakage protection detected 30mA-900mA fault current values, mainly used for indirect grounding protection to ensure personal safety.

■ Over voltage protection

Too high voltage will result in extent damage of motor insulation, and when the operating voltage of motor exceeds the protection voltage, the protector will protect according to the set requirements, and Trip within the Trip (delay) setting time.

■ Under voltage protection

Too low voltage will cause the motor speed to reduce, or even stop, when the operating voltage of motor drops to the under

voltage protection set, the protector will protect according to the set requirements, and Trip within the Trip (delay) setting time.

■ Locked-rotor protection (starting over current protection)

During the process of motor starting, because of the load is too large or their own mechanical reasons, motor shaft may be stuck. Without the timely lifting of failure, the motor will overheat and burn down because of decreasing insulation property. When the current reaches the current operation set, protection trips in tripping(delay) set timely and avoids burning motor.

■ Blocking protection

Blocking protection used for motor shaft stuck during the process of motor running. When the current reaches the current operation set, protection trips in tripping(delay)set timely and avoids burning motor.

■ Over power protection

When the percentage of load power and rated power is higher than the preset action value, the protector will act or alarm within the action time set.

■ Under power protection

When the percentage of load power and rated power is lower than the preset action value, the protector will act or alarm within the action time set.

■ Temperature protection

Motor temperature protection regards the thermistor values sent by thermistor detector embedded in the motor's stator windings or bearings as the protection conditions. When the protector detects that the value of the thermistor is larger than the preset protection value, the protector will Trip Within Trip(delay) set time.

External fault protection (technology interlock protection)

■ Control authority

Protector has a variety of control authority, and users can set different control authority to control the motor according to the actual needs.

"Full-controlled: when the users set the control authority to ""full-controlled"", then the users can press a button on the display unit to achieve On-site control."

System, PC remote control, DI termination to achieve On-site control starting and stopping of motor.

The starting and stopping of protector can only be controlled by local via using the keys on the display unit.

The starting and stopping of protector can only be controlled by on-site via DI input terminal on the protector. Remote: the starting and stopping of protector can only be controlled via remote communication of PC.

One in three by using DI end to select the control position (select one from local, on-site, and remote). Starting control

The protector has different start control mode, and the users can select different start control way according to the actual situation.

Protection mode 2, under this mode, the protector can not be controlled by local and on-site. Manual mode: under this mode, it is need to manually control 2 starter relay separately.

Two-step mode, under this mode, only need to adopt manual operation for start 1, after the set delay time, start 1 will automatically disconnect and simultaneously start 2 action. If the self-start function is opened up, when the protector is power on, it will start 1 and start 2 relays in automatic sequence of actions.

" Two-speed mode: under this mode, ""start 1"" is low-speed operation, and ""start 2"" is high-speed operation." self-start

During power up or power restoration process, the protector will start the motor according to setting sharing.

" If the self-start control of system is ""open", and "self-start mode is set to ""restore"", then the protector will determine whether there is need to re-start based on the state before power off, if the system is running before power off, then it will start to run according to the set self-start delay time after power on; if the self-start mode is ""start"", then the protector can achieve motor group delay time sequence starting once power on."

loss voltage restart

"This function is only valid when with voltage function and loss voltage restart function must be set to ""start 1"" or ""start 2"" state, while there is need to close the under voltage Trip function."

When the motor is running and zero current is detected, then begin timing under loss of pressure; within immediate time of loss voltage, if the voltage can be restored to voltage setting set under the loss of pressure starting, the starter relay is not Tripd; when after the greater immediate time of loss of pressure, the starter relay will be Tripd. If the voltage can be restored to voltage setting set under the loss voltage restarting within the time, the protector will start the motor under delay after delay restart. When power failure time is greater than the loss voltage restarting time allowed, this eliminates relevant information, no re-start any more.

Notes: "1. two-speed motor starting time, overload, under load, locked-rotor, blocking, over power, under power, short circuit in two sets, when carry out setting, there is need to select low-speed switch in system parameters firstly"; "OFF" is the low-speed parameter setting"; "ON" is the high-speed parameter setting."

2. 4 to 20 analog output: Default 2 gal IA corresponding 2 times the rated current value. Users can also set their own required corresponding parameters and magnification of analog output (note: magnification setting is only valid for the current). See the below table:

Table 15 Transmission setting instructions

Transmission type	Transmission magnification
0. A-phase current	Ie integral multiples (1-8)
1. B-phase current	Ie integral multiples (1-8)
2. C-phase current	Ie integral multiples (1-8)
3.mean current	Ie integral multiples (1-8)
4. AB line voltage	95-190,330-990,190-570 (50% -150% system voltage) corresponds
5. BC line voltage	95-190,330-990,190-570 (50% -150% system voltage) corresponds
6. CA line voltage	95-190,330-990,190-570 (50% -150% system voltage) corresponds
7. Average line voltage	95-190,330-990,190-570 (50% -150% system voltage) corresponds
8. PTC (100-30K)	Default 100-30000 corresponds to 4-20mA
9. Thermal capacity	Default 0-100% corresponds to 4-20mA
10. Power	Rated power integral multiple -8)
11. Frequency	30-70Hz corresponds to 4-20mA

10 Cautions

1. The Trip relay (terminal no.95, 96) is normally open, and closed after power on.
2. The protector can not display real-time "alarm information, which can only display alarm condition when enter the query menu." Customers are advised to view when the fault alarm is stable.
3. The protector can measure 7.2 times overload current of specifications ordered in maximum, namely, 100A protector can measure 720A current in maximum.

When set the short-circuit protection, customers need to set reasonable parameters according to specifications set by the protector.

4. when the start control of protector is set to "two-step start", "starting – delay" time should be less than the start time."
5. Pei-rotating protection Trip delay time should be less than the starting time, otherwise the locked-rotor protection function will not be achieved.
6. When the protector is equipped with grounding / earth leakage protection, the conducting wire of \ protector introduced from zero sequence current transformer is recommended to use shield wire, otherwise this may lead to inaccurate

measurements.

7. Protector provides asynchronous half-duplex RS485 communication interface, adopt MODBUS-R 'four protocol, and a variety of data can be transmitted on the communication line. Theoretically, a single line can simultaneously connect up to 128 protectors, and each protector can set their own address (Addr). Communication connection is recommended to use shielded twisted pair wire whose diameter should be not less than 0.5mm²⁰. When wiring, make communication lines away from power cable or other strong electric field environment.

8. The rated current of protector should be proper rated operational current value of the motor; if this setting value is lower than the normal value of the motor's rated operational current, it may cause that the motor can not be started normally; higher than normal rated operation current value of motor, the protector may not carry out normal protection when the motor appears fault.

9. Once the protector occurs Trip, the protector should be reset after debugging and before re-start the motor, otherwise it will not start the motor.

10. After the thermal overload protection of motor, due to the heat accumulation, it can be reset after cooled.

11. In the actual use on-site, the unreasonable protection parameters settings may cause the motor to has protection action once the motor started or no protection action; at this time, all protection functions can be turned off, various protection parameters can be reset in accordance with various parameters obtained from normal operation of the motor.

12. if the various protection parameters set by protection are appropriate, but the protector has action once the motor started, at this time, the cause of fault can be found according to the action code displayed by protector.

13. The protector's parameters are default settings when made(unless users have special requirements); In actual use, various protection functions must be opened by users based on the actual needs, and various parameters can be set.

14. Unless otherwise specified by users, the connecting line of transformer and protector body is 1m in default, and the connecting line of protector body and display unit is 1.5m in default.

15. Special requirements should be specified in the order if users have special requirements(such as single-phase motor protector, length of connection line, etc.).

11 Order sample

Example:

Type: ARD3-25A/TCSR+90FL Auxiliary power: AC220V

Rated current of motor: 6.3A ~ 25A applies z three-phase motor

Measurement parameters: three-phase current, temperature resistance

Additional function : Additional functions: start control, thermal protection, alarm output, RS485 communication, 20 display methods of SOE event records: 90FL (LCD)