

099



AM5 微机保护装置
AM5 Microcomputer Protection Device

操作说明书 V1.9
Operational Manual V1.9

安科瑞电气股份有限公司
Acrel CO.,LTD

申 明

DECLARATION

版权所有，未经本公司之书面许可，此手册中任何段落，章节内容均不得被摘抄、拷贝或以任何形式复制、传播，否则一切后果由违者自负。

本公司保留一切法律权利。

All rights reserved. No part of this publication may be reproduced, stored in a retrieval system, or transmitted in any form by any means, electronic, mechanical photocopying, recording, or otherwise without prior permission of our company. The violator will bear the dependent legal responsibility.

本公司保留对本手册所描述之产品规格进行修改的权利，恕不另行通知。

订货前，请垂询当地代理商以获悉本产品的最新规格。

We reserve all the rights to revise product specification without notice. Please consult local agent to get the latest information of our products specification.

目 录

第一章 装置介绍.....	4
Chapter 1 Device Introduction.....	4
1 概述.....	4
1 Information.....	4
2 硬件资源.....	4
2 Hardware Resources.....	4
3 功能对照表.....	5
3 Protection Function.....	5
第二章 技术参数.....	6
Chapter 2 Technical Parameters.....	6
1 额定参数.....	6
1 Rated parameters.....	6
1.1 工作电源.....	6
1.1 Power supply.....	6
1.2 输入激励电压.....	6
1.2 Rated voltage.....	6
1.3 输入激励电流（保护电流）.....	6
1.3 Rated current (Protection current).....	6
1.4 频率.....	7
1.4 Frequency.....	7
1.5 开关量输入.....	7
1.5 Digital Input.....	7
1.6 开关量输出.....	7
1.6 Digital Output.....	7
2 主要技术性能.....	7
2 Basic mechanical design feature.....	7
3 正常工作环境条件.....	8
3 Normal working conditions.....	8
4 绝缘性能.....	8
4 Insulating property.....	8
5 电磁兼容性能.....	8
5 Electromagnetic compatibility performance.....	8
第三章 装置操作说明.....	10
Chapter 3 Operational Manual.....	10
1 前面板说明.....	10
1 Surface.....	10
2 按键说明.....	10
2 Key.....	10
3 菜单说明.....	11
3 Menu instructions.....	11
3.1 快速导航.....	11

3.1 Fast navigation.....	11
3.2 配置.....	13
3.2 Configuration.....	13
3.3 定值.....	14
3.3 Parameter.....	14
3.4 调试.....	17
3.4 Debug.....	17
3.5 记录.....	17
3.5 SOE.....	17
3.6 通讯.....	18
3.6 Communication.....	18
3.7 控制.....	19
3.7 Control.....	19
3.8 时间.....	19
3.8 Time.....	19
3.9 信息.....	20
3.9 Information.....	20
第四章 装置安装及接线.....	21
Chapter 4 Installation and Application.....	21
1 安装方法.....	21
1 Installation.....	21
2 开孔尺寸.....	22
2 Outlines.....	22
3 接线方法.....	23
3 Connection methos.....	23
附录 A 装置出厂默认定值表.....	24
Accessories A Setting Value.....	24
附录 B 遥信量地址表.....	52
Accessories B Remote address table.....	52
附录 C 遥测量地址表.....	60
Accessories C Telemetry address table.....	60
附录 D 事件记录.....	71
Accessories D Event Record.....	71

第一章 装置介绍

Chapter 1 Device Introduction

1 概述

1 Information

AM5 系列微机保护装置集保护、控制于一体，适用于 35kV 及以下电压等级的用户终端变电站（所），可实现用户变电站的全面保护和控制。应用领域覆盖电力、水利、交通、石油、化工、煤炭、冶金等行业。

AM5 series microcomputer protection device are applicable to the user substation which the input voltage is 35kv or above. AM5 can be used to protect and control the user substation, and is be widely used to Power Industry, Water conservancy industry, Traffic Industry, Oil industry, Chemical industry, Coal Industry, Metallurgical Industry and so on.

2 硬件资源

2 Hardware Resources

表 1.1 AM5 硬件资源

Table1.1 AM5 Hardware Resources

Hardware Resources	AM5-F	AM5-T	AM5-M	AM5-C	AM5-B	AM5-U	AM5-DB
电流采集 Input Current	8	8	8	8	8	0	8
电压采集 Input Voltage	4	4	4	4	4	4	4
开关量采集 DI	16	16	16	16	16	16	16
继电器输出 DO	10	10	10	10	10	10	10

AM5 系列微机保护装置的额定技术参数如表 1.2。

The detal technical parameters of AM5 series microcomputer protection device is shown as table 1.2.

表 1.2 AM5 技术参数

Table1.2 AM5 Technical parameters

	额定输入 Rated input	范围 Range	精度 accuracy	功耗 power consumption
工作电源 Power supply	AC220V/DC220V, DC110V,DC48V	额定电压×(1±20%) Rared input×(1±20%)	-----	≤10W (直流) ≤10W (DC)
输入电压 Voltage input	AC 100V/100/ $\sqrt{3}$ V	1~120V	±0.5%	每相功率损耗不大于 0.5VA ≤0.5VA single phase
输入电流 Current input	AC 5A /1A	0.04In~15In	±0.5%	每相功率损耗不大于 0.5VA ≤0.5VA single phase
频率 Frequence	50Hz	45~55Hz	±0.1Hz	-----
开入 DI	AC220V/DC220V, DC110V, DC48V	额定电压×(1±20%) Rared input×(1±20%)	-----	每通道功率消耗≤1W (DC220V) ≤1W (DC220V) single DI

3 功能对照表

3 Protection Function

功能 Function	类型 Model	AM5-F	AM5-T	AM5-M	AM5-C	AM5-B	AM5-U1	AM5-DB
三段过流保护 Three-stage over current protection		√	√					
两段过流保护 Two-stage over current protection				√	√	√		√
两段 I01 过流 Two-stage over zero-current1 protection		√	√	√	√			
两段 I02 过流 Two-stage over zero-current2 protection		√	√	√				
反时限过流保护 Inverse time over current protection		√	√	√	√	√		
零序反时限过流保护 Inverse time over zero-current protection		√	√	√	√			
过负荷告警 Overload alarm		√	√	√				
过负荷跳闸 Overload trip		√	√	√				
控故障告警 Control circuit fault alarm		√	√	√	√	√		√
低电压告警 Under voltage alarm		√		√	√		√	√
低电压保护 Under voltage trip		√		√	√			
过电压告警 Over voltage alarm		√		√	√		√	√
零序过压告警 Over zero-voltage alarm		√		√	√		√	√
PT 断线告警 PT disconnection alarm		√	√	√	√	√	√	√
FC 闭锁 FC atresia		√	√	√	√			
负序过流 (两段/反时限) Negative sequence overcurrent protectio (two stage/Inverse time)				√				
自产零序过压告警 Self-produced over zero-voltage alarm							√	
非电量跳闸/告警 Non electric trip/alarm		√	√	√	√			

第二章 技术参数

Chapter 2 Technical Parameters

1 额定参数

1 Rated parameters

1.1 工作电源

1.1 Power supply

额定电压: AC220V/DC220V, 或 AC110V/DC110V, 或 DC48V

Power supply: AC/DC220V, or AC/DC110V, or DC48V (Reference the wiring diagram)

范 围: 额定电压 $\times (1 \pm 20\%)$

Range: Power supply $\times (1 \pm 20\%)$

功 耗: $\leq 10\text{W}$ (直流)

Maximum power consumption: $\leq 10\text{W}$ (DC)

1.2 输入激励电压

1.2 Rated voltage

额 定 值: AC 100V 或 $100/\sqrt{3}\text{V}$

Rated voltage: AC 100V or $100/\sqrt{3}\text{V}$

测量范围: 1~120V

Range: 1~120V

准 确 度: $\pm 0.5\%$

Accuracy: $\pm 0.5\%$

功率损耗: 每相功率损耗不大于 0.5VA

Power consumption: $\leq 0.5\text{VA}$ (single phase)

过载能力: 1.2 倍额定电压, 连续工作;

2 倍热过载, 允许 10s。

Overload capacity: 1.2 times rated voltage for continuous work;

2 times for 10 seconds.

1.3 输入激励电流 (保护电流)

1.3 Rated current (Protection current)

额 定 值: AC 5A 或 1A

Rated current: AC 5A/1A (See the device wiring diagram)

测量范围: $0.04I_n \sim 15I_n$

Range: $0.04I_n \sim 15I_n$

功率损耗: 每相功率损耗不大于 0.5VA

Power consumption: $\leq 0.5\text{VA}$ (single phase)

过载能力: 2 倍额定电流, 连续工作;

40 倍额定电流, 允许 1s。

Overload capacity: 2 times rated current for continuous work;

40 times for 1 second.

1.4 频率

1.4 Frequency

额定频率: 50Hz 或 60Hz

Rated frequency: 50Hz or 60Hz

频率范围: 45~55Hz 或 60Hz

Range: 45~55Hz or 60Hz

准确度: $\pm 0.1\text{Hz}$

Accuracy: $\pm 0.1\text{Hz}$

1.5 开关量输入

1.5 Digital Input

额定电压: AC/DC220V, 或 AC/DC110V, DC48V

Rated Voltage: AC/DC220V, AC/DC110V, DC48V (similar to power supply)

电压范围: 额定电压 $\times (1 \pm 20\%)$

Voltage range: Rated Voltage $\times (1 \pm 20\%)$

功率消耗: 每通道功率消耗 $\leq 1\text{W}$ (DC220V)

Power consumption: $\leq 1\text{W}$ (DC220V) (single channel)

1.6 开关量输出

1.6 Digital Output

机械寿命: ≥ 10000 次

Mechanical life: ≥ 10000

接通容量: $\geq 1000\text{W}$, L/R = 40ms

Switching capacity: $\geq 1000\text{W}$, L/R = 40ms

导通电流: 连续 $\geq 5\text{A}$, 短时 (200ms) $\geq 30\text{A}$

On current: continuous $\geq 5\text{A}$, short time (200ms) $\geq 30\text{A}$

断开容量: $\geq 30\text{W}$, L/R = 40ms

Interrupting capacity: $\geq 30\text{W}$, L/R = 40ms

2 主要技术性能

2 Basic mechanical design feature

电压元件: 整定值容许误差应不大于 $\pm 3\%$; 过压返回系数 0.95, 欠压返回系数 1.05;

Voltage element: The allowable error of setting value should not be greater than $\pm 3\%$; the return coefficient of overpressure should be 0.95, and the return coefficient of underpressure should be 1.05.

电流元件: 整定值容许误差应不大于 $\pm 3\%$; 过流返回系数 0.95, 欠流返回系数 1.05;

Current element: The allowable error of setting value should not be greater than $\pm 3\%$; the return coefficient of overcurrent should be 0.95, and the return coefficient of undercurrent should be 1.05.

频率元件: 整定值容许误差应不大于 $\pm 0.02\text{Hz}$;

Frequency element: The allowable error of setting value should not be greater than $\pm 0.02\text{Hz}$.

比较元件：返回系数为 0.95；

Comparison element: Return coefficient is 0.95

反时限元件：反时限动作时间误差为±5%或±40ms；返回系数为 0.95；

Inverse time element: The time error of the inverse time limit action is ±5% or ±40ms, and the return coefficient is 0.95.

时间元件：延时时间 2s 内误差≤40ms；延时时间大于 2s，误差≤（1%）整定值±40ms。

Timing element: Delay time within 2 seconds error is ≤40ms, delay time is more than 2 seconds, error ≤ 1% tuning value ±40ms.

3 正常工作环境条件

3 Normal working conditions

环境温度：-10℃~+55℃；

Ambient temperature: -10℃~+55℃；

装置的贮存、运输允许的环境温度为-25℃~+70℃；

Device storage, transport allows the ambient temperature is -25℃~+70℃；

相对湿度：5%~95%（产品内部不凝露，不结冰）；

Relative humidity: 5%~95% (The product does not condensation and freeze inside)；

海拔高度：≤4000m。

Altitude: ≤4000m。

4 绝缘性能

4 Insulating property

绝缘电阻：>100MΩ，500Vdc

Insulation resistance: >100MΩ，500Vdc

介质强度：回路和地之间，独立回路之间：工频耐压 2Kv

Dielectric strength: Between the circuit and the ground, between the independent loop: power frequency voltage withstand 2kV.

冲击电压：±5kV(1.2/50μs, 0.5J)

Impulse voltage: ±5kV(1.2/50μs, 0.5J)

5 电磁兼容性能

5 Electromagnetic compatibility performance

	试验项目 Test item	要求 Requirement
1	辐射发射限值检验 Radiation emission limit test	满足 IEC 60255-26:2013 规定 Meet the requirements of IEC 60255-26:2013
2	传导发射限值检验 Conduction emission limit test	满足 IEC 60255-26:2013 规定 Meet the requirements of IEC 60255-26:2013
3	射频电磁场辐射抗扰度 Radio-frequency electromagnetic field radiation immunity	满足 IEC 60255-26:2013 规定，严酷等级 10V/m Meet the requirements of IEC 60255-26:2013, severity is 10V/m.
4	静电放电抗扰度	满足 IEC 60255-26:2013 规定，严酷等级为 IV 级

	Electrostatic discharge immunity	Meet the requirements of IEC 60255-26:2013, severity is IV level.
5	射频场感应传导骚扰抗扰度 Disturbance immunity of RF Field Induction conduction	满足 IEC 60255-26:2013 规定, 严酷等级骚扰电平 10V Meet the requirements of IEC 60255-26:2013, severe grade disturbance level is 10V.
6	电快速瞬变脉冲群抗扰度 Immunity of electric fast transient pulse group	满足 IEC 60255-26:2013 规定, 严酷等级为 A 级 Meet the requirements of IEC 60255-26:2013, severity is A level.
7	慢速阻尼振荡波抗扰度 Slow-damped oscillation wave immunity	满足 IEC 60255-26:2013 规定, 共模 2.5kV, 差模 1kV Meet the requirements of IEC 60255-26:2013, the common mode is 2.5 and the difference module is 1.
8	浪涌抗扰度 Surge immunity	满足 IEC 60255-26:2013 规定, 严酷等级为 IV 级 Meet the requirements of IEC 60255-26:2013, severity is IV level.
9	交流和直流电压暂降中断影响试验 Effect test of AC and DC voltage sag interruption	满足 IEC 60255-26:2013 规定 Meet the requirements of IEC 60255-26:2013
10	工频磁场抗扰度 Power frequency magnetic field immunity	满足 IEC 60255-26:2013 规定, 严酷等级为 IV 级 Meet the requirements of IEC 60255-26:2013, severity is IV level.

第三章 装置操作说明

Chapter 3 Operational Manual

1 前面板说明

1 Surface



图 3.1 AM5 前面板

Fig 3.1 AM5 Surface

2 按键说明

2 Key

表 3.1 AM5 按键功能说明

Table 3.1 AM5 Key function

按键 key	主要功能 function	按键 key	主要功能 function
	复归 reset		向上移动选项或数字增大 up/increase
	确认 enter		向下移动选项或数字减小 Down/decrease
	返回 esc		向左移动选项或页面前翻 left
	主菜单 menu		向右移动选项或页面后翻 fight
	事件记录查看 soe		保留 resaved

3 菜单说明

3 Menu instructions

装置上电即进入主界面，主界面分三个界面显示：运行界面、遥测量界面、遥信量界面，如图 3.2~3.4 所示。各个界面之间可以通过左右键来切换显示。

The device is powered on to enter the main interface, the main interface is divided into three interfaces: running interface, telemetry interface, remote interface, as shown in figures 3.2-3.4. Each interface can switch between the display through the left and right keys.

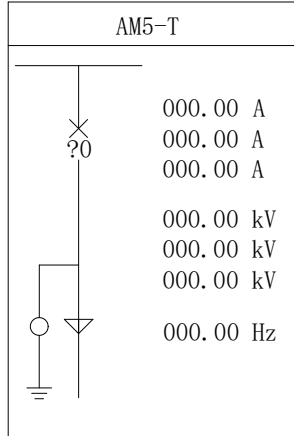


图 3.2 运行界面

遥测	当前值	单位
Ia	0000.00	A
Ib	0000.00	A
Ic	0000.00	A
I01	0000.00	A
I02	0000.00	A
U1	0000.00	V
U2	0000.00	V
U3	0000.00	V
U4	0000.00	V
Fr	0000.00	Hz
PF	0000.00	

图 3.3 遥测量界面

遥信	状态
合位	分
分位	分
运行位置	分
试验位置	分
接地刀闸	分
远方/就地	分
弹簧未储能	分
手动分闸	分
非电量1	分
非电量2	分

图 3.4 遥信量界面

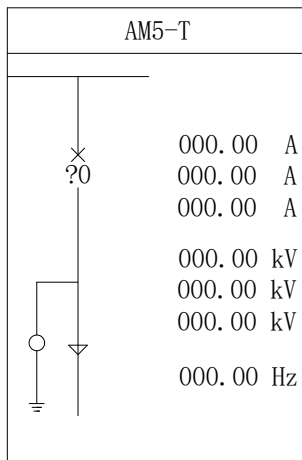


图 3.2 运行界面

Name	Value	Unit
Ia	0000.000	A
Ib	0000.000	A
Ic	0000.000	A
I01	0000.000	A
I02	0000.000	A
U1	0000.000	V
U2	0000.000	V
U3	0000.000	V
U4	0000.000	V
Fr	0000.000	Hz
PF	0000.000	

图 3.3 遥测量界面

Name	State
CCB On	Off
CCB Off	Off
Working Posi.	Off
Testing Posi.	Off
GroundSwitch	Off
Remote	Off
Discharge	Off
ManualTrip	Off
Non-elec.1	Off
Non-elec.2	Off

图 3.4 遥信量界面

Figure3.2 Run interface Figure3.3 Telemetry interface Figure3.4 Remote interface

注：遥信量界面中，当装置处于远方状态时，开入量“远方/就地”显示“合”，当装置处于就地状态时，开入量“远方/就地”显示“分”。

Notice: When the device is in the remote state, the input quantity "remote / local" shows "close", and when the device is in the local state, the "remote / local" shows "branch".

3.1 快速导航

3.1 Fast navigation

装置菜单为多级菜单，在任一幅主界面里按“确认”键即进入主菜单，主菜单分为 8 个子菜单，如图 3.5，由子菜单名称、图标构成。选定任一子菜单后按“确认”键进入菜单，

按“返回”键返回上级菜单。图 3.6 为装置的快速导航示意图，可以依据该图迅速查找相关参数。

The device menu is multi-level menu, users can press the "Enter" key to enter the main menu. The main menu is divided into 8 sub-menus, as shown in figure 3.5, which is composed of submenu name and icon. After selecting a submenu, press "Enter" key to enter the menu and press "Esc" key to return to the superior menu. Figure 3.6 is a quick navigation map, which can be used to quickly find relevant parameters.

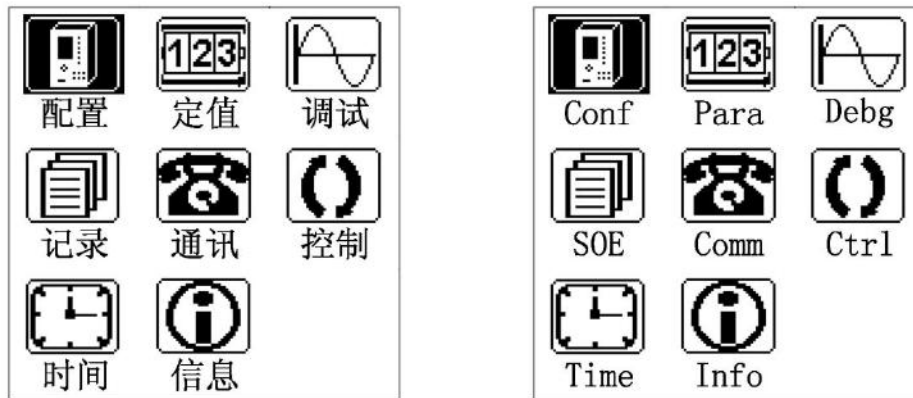
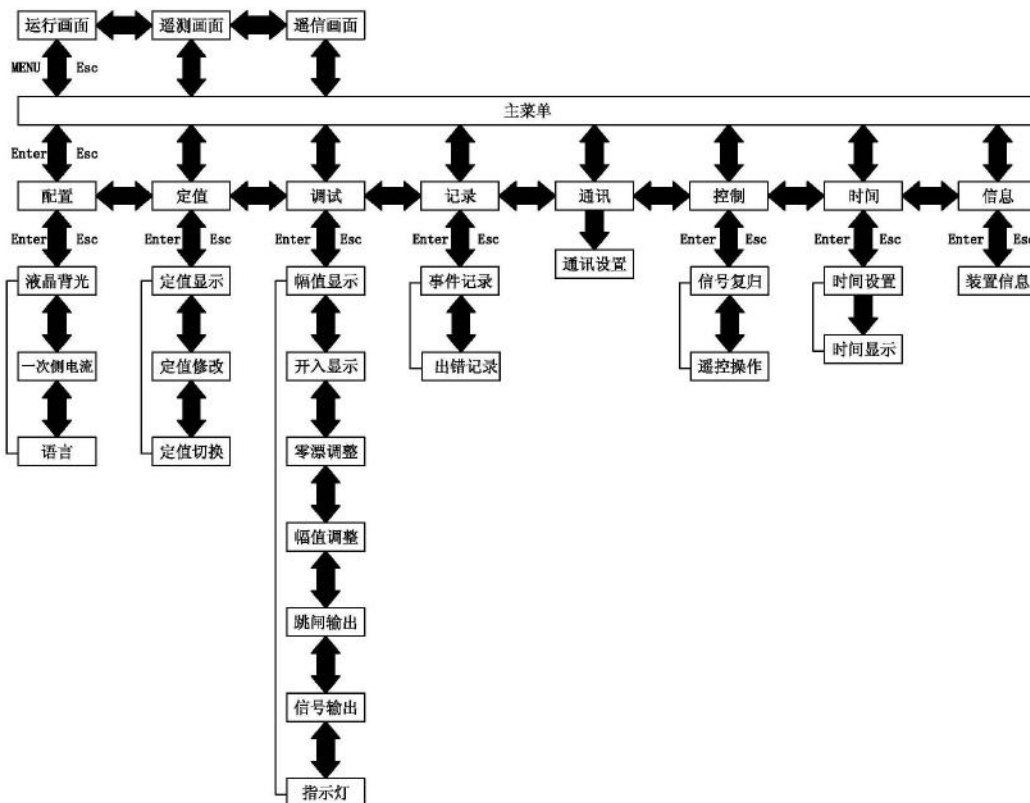


图 3.5 主菜单

Fig 3.5 Main menu



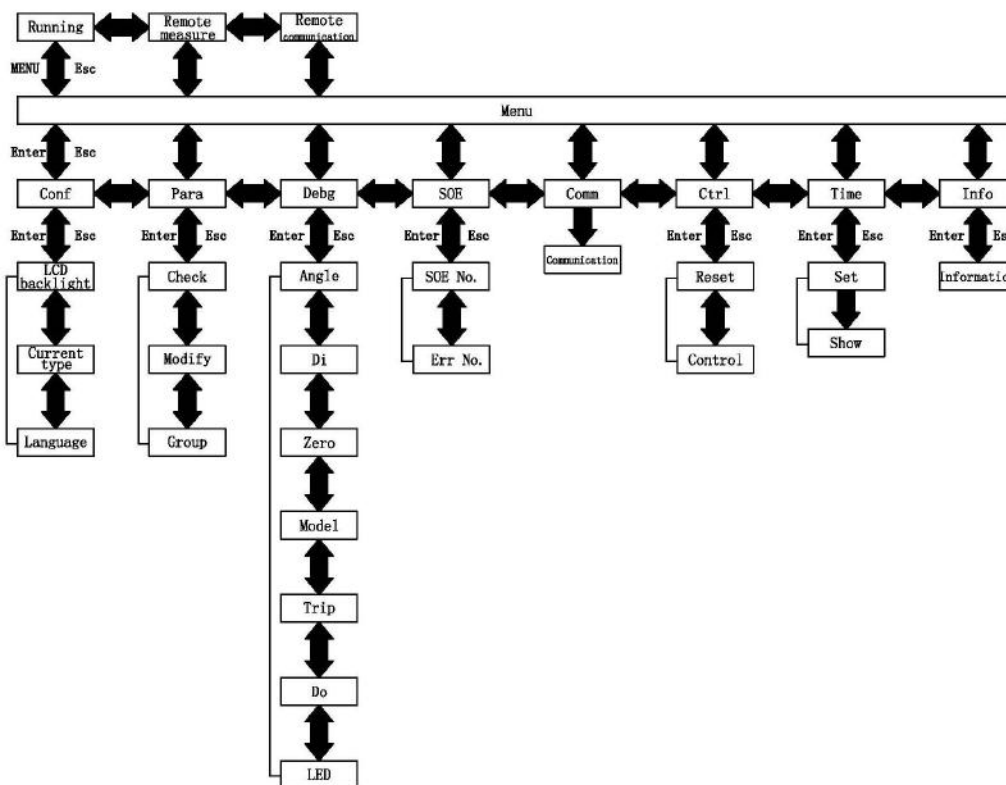


图 3.6 快速导航示意图

Fig 3.6 Menu navigation

3.2 配置

3.2 Configuration

“配置”菜单可以设置液晶背光时间，如图 3.7，修改完成后，按“确认”键退出修改，再按“返回”键返回，装置会跳出数据保存界面，如图 3.8，按“确认”键保存修改并返回主菜单，按“返回”键不保存修改且返回主菜单。

“Conf” menu can set the LCD backlight time, as shown in figure 3.7, after the change is completed, press the “Enter” key to exit the changes, and then click “Esc” button to return to, the device will jump out of the data interface, as shown in figure 3.8, press “Enter” button to save the changes and return to the main menu, press the “Esc” key does not save the changes and return to the main menu.

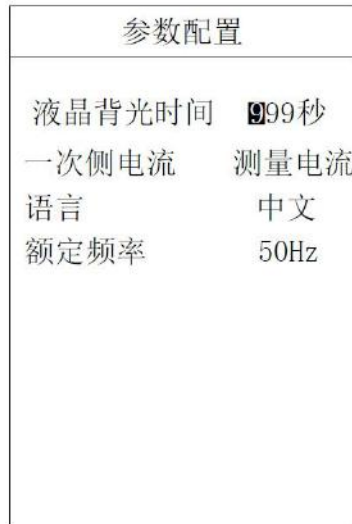


图 3.7 液晶背光时间设置

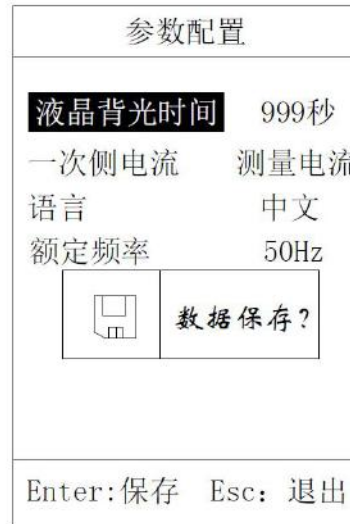


图 3.8 数据保存提示

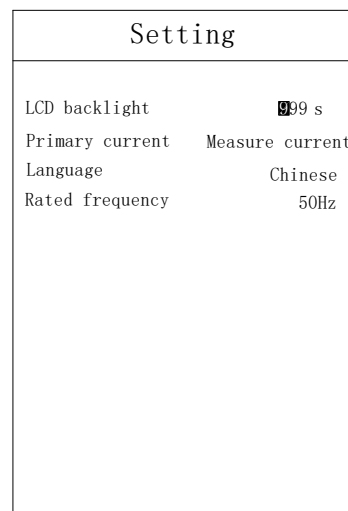


Figure 3.7 LCD backlight time settings

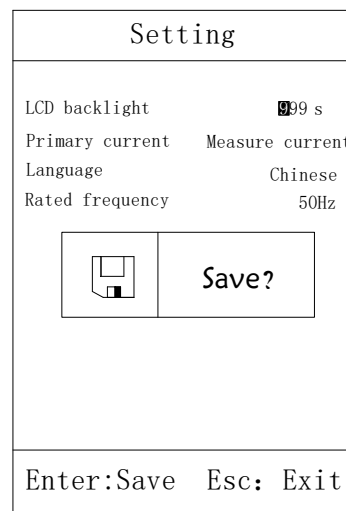


Figure 3.8 Data saving

3.3 定值

3.3 Parameter

“定值”菜单里有定值显示、定值修改、定值切换三个子菜单，如图 3.9。

The menu “Para.” has 3 submenus: Check、Modify、Group, as shown in Figure 3.9.

3.3.1 定值显示

3.3.1 Check

“定值显示”菜单中有选择定值区、运行定值区两个子菜单。选择定值区里有四组有效定值，分别为 00、01、02、03 四个区号，选择相应区号，如图 3.10，按“确认”键进入定值显示。所有定值分页显示，按左右键可分页查看，如图 3.11。运行定值区里显示装置当前运行的定值区。

The “Check” menu has two submenus, which are selected value section and running value section. The selected value section has 4 section:00、01、02 and 03, as shown in figure3.10. Each section can be set

different values. The running value section is shown the nowadays value of AM4, all value pagination displays, press left and right key to view, as shown in figure 3.11.

定值管理
定值显示
定值修改
定值切换

图 3.9 定值菜单

定值管理
选择定值区:00
运行定值区:00

图 3.10 设置选择定值区

定值显示[00]	(001)
CT变比	0300.00
PT变比	0100.00
过流一段投退	退出
过流一段定值	0010.00A
过流一段延时	0000.00s

图 3.11 定值显示

Values
Check
Modify
Group

Figure 3.9 Parameter

Values
Selected:00
Running:00

Figure 3.10 Selection area

Check[00]	(001)
CT	0300.00
PT	0100.00
E. 3I>>>	No
3I>>>	0010.00A
3I>>>. T	0000.00s

Figure 3.11 Check

3.3.2 定值修改

3.3.2 Modify

“定值修改”菜单有选择定值区、运行定值区两个子菜单，该菜单**初始密码为“0008”**。

The “Modify” menu has two submenus in the selected value area and the running value area. The initial password of this menu is “0008”.

在选择定值区内设置需修改的定值区号，按“确认”键进入定值修改界面。这里分页显示所有定值信息，可通过上下左右键选择需修改的定值，先按“确认”键，再按上下键设置修改内容，如图 3.13。修改完成后，按“确认”键确定，再对下一个需要修改的定值进行修改，待全部定值修改完成后，再按“返回”键退出，这时若数据有改动，则装置会弹出同图 3.8 所示的数据保存对话框，按“确认”键保存修改并返回定值管理菜单，按“返回”键不保存且返回定值管理菜单。

Set the value area code to be modified in the fixed value area, and press “Enter” to enter the value modification interface. Here pagination displays all the value information, and use can select the value that needs to be modified by selecting the left and right keys, press the “Enter” button first, and then press the

up and down key to set the modified content, as shown in figure 3.13. After the set is completed, press the “Enter” button, then set the next one as the same way.

When the all setting is completed, press “Esc” button to exit, at this time if the data changes, the device will pop up with the data dialog box shown in figure 3.8, press “enter” button to save the changes and return to value management menu, click “Esc” button is not saved and to return to value management menu.

运行定值区只显示装置当前运行的定值区号，这里不做修改。

The running value area only displays the current running value area of the device. and no modification is made here.

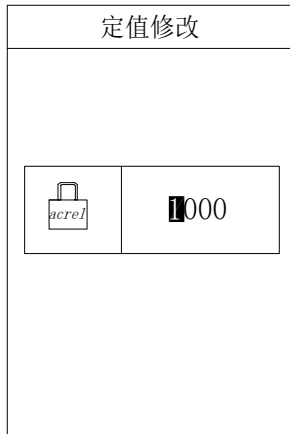


图 3.12 输入密码对话框

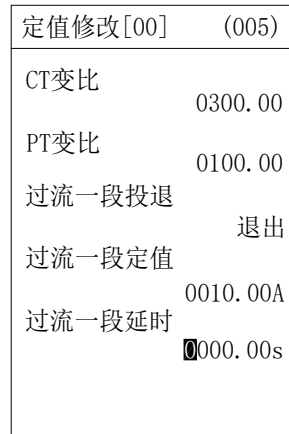


图 3.13 定值修改

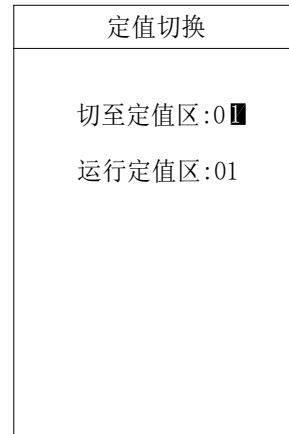


图 3.14 定值切换

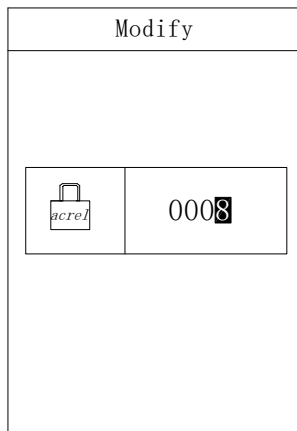


Figure 3.12 Enter password

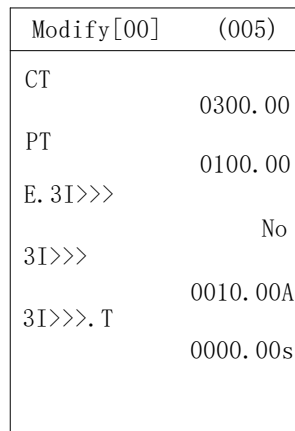


Figure 3.13 Modify

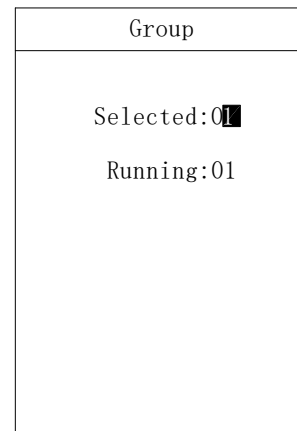


Figure 3.14 Group

3.3.3 定值切换

3.3.3 Group

“定值切换”菜单有切至定值区、运行定值区两个子菜单，该菜单密码为“0008”。切至定值区内有 00-03 四个有效定值区可供切换，设置好后，按“确认”键确定，再按“返回”键返回主菜单。运行定值区将显示当前运行的定值区号，如图 3.14。

The “Group” menu has two submenus, which are cut to the value area and run the value area. The password of this menu is “0008”. The selected section shows the expected section which uses want to set, which can be set as 00-03. The running section shows the nowadays value of the device AM4. The details are shown in figure 3.14.

After setting, press the “Enter” button to determine, and then press the “esc” key to return to the main menu. The running value area will display the current running value area of the device, as shown in figure 3.14.

3.4 调试

3.4 Debug

“调试”菜单为出厂前测试装置使用，可对装置进行零漂调整、幅值调整、继电器输出、指示灯输出测试。

The “Debug” menu is used to manufacturer to test the device before it leaves the factory. The function includes zero adjustment、 amplitude adjustment、 digital output、 lamp output and so on.

该菜单功能使用时请与制造商联系。

When use the “Debug.” function, please contact the manufacturer first!

3.5 记录

3.5 SOE

“记录”菜单中可以查看事件记录、出错记录两类信息。

By “SOE” menu, users can view two types of event record, error record and event record.

3.5.1 事件记录

3.5.1 Event record

“事件记录”菜单可显示事件序号、事件总数、事件代码、事件发生时间、事件名称、动作类型（动作或告警）等信息。如果是保护动作引起事件记录，还会记录事件发生时刻动作元件动作值和时间，如图 3.15 所示。装置可保存大于 200 条事件记录。

“SOE” menu shows the event sequence, event number, event code, event time, event action type (action or alarm), and so on. It can also record the action values and time of the protection event, as shown in figure 3.15. The device can save more than 200 event record.

3.5.2 出错记录

3.5.2 Error record

“出错记录”菜单可显示出错序号、出错总数、出错时间、出错名称、出错码等信息，如图 3.16 所示。装置可保存大于 200 条记录。

“Error” menu shows the error sequence, event number, error time, error name, error code and so on, as shown in figure 3.16. The device can save more than 200 event record.

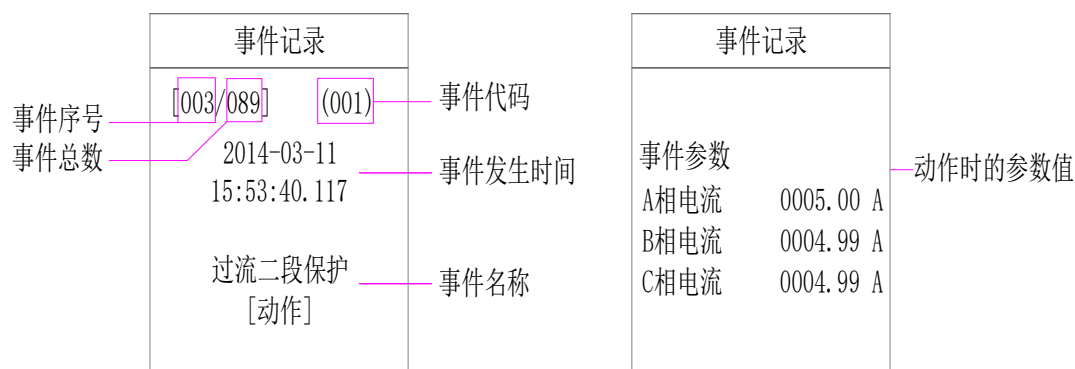


图 3.15 事件记录画面

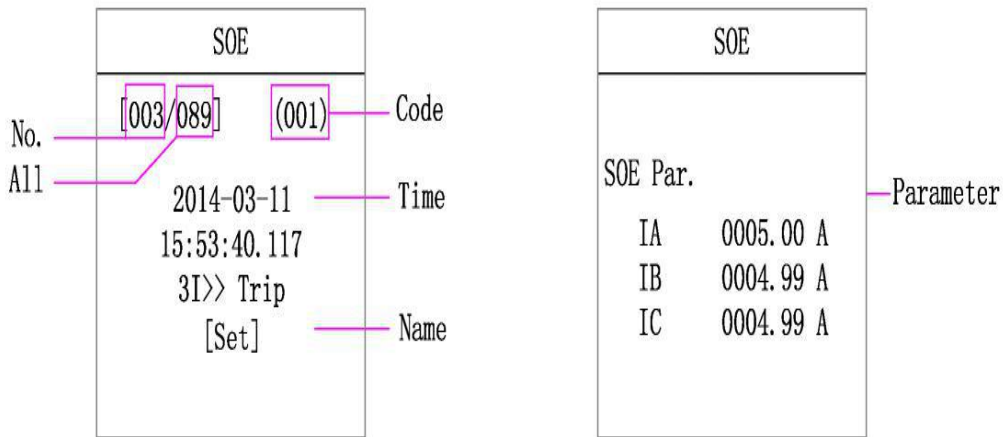


Figure 3.15 Event record screen

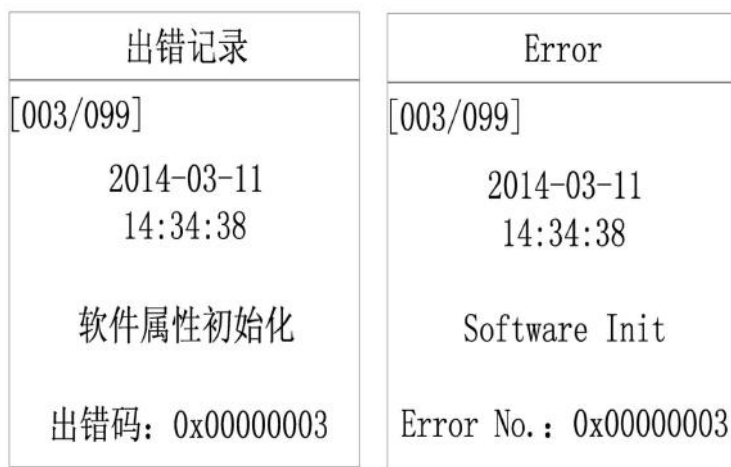


图 3.16 出错记录画面 Figure 3.16 Error event screen

3.6 通讯

3.6 Communication

“通讯”菜单可设置通讯地址及波特率，如图 3.17。通讯参数可从表 3.2 选择参数进行设置。设置完成后先按“返回”键退出，然后按“确认”键保存，再按“返回”键返回主菜单。

The “Comm” menu can set the communication address and baud rate, as shown in figure 3.17. Communication parameters can be set from table 3.2 selection parameters. After setting, press “Esc” key to exit, then press “Enter” to save, then press “Esc” key to return to the main menu.

表 3.2 通讯参数设置

Table 3.2 Communication setting parameter

设置量 Setting parameter	参数 Parameter
装置地址 Device address	0~255
比特率 Baud rate	4800、9600、19200、57600、115200
数据位 Date bits	8、9
停止位 Stop bit	1、1.5、2
校验方式 Calibration method	无校验、偶校验、奇校验 No calibration、Even calibration、 Odd calibration
规约选择 Statutory choice	MODBUS、IEC103

通讯设置	
装置地址	000
COM1规约	IEC103
COM1波特率	9600
COM1数据位	8
COM1停止位	1
COM1校验方式	无校验
COM2规约	IEC103
COM2波特率	9600
COM2数据位	8
COM2停止位	1
COM2校验方式	无校验

Communication	
Addr	000
COM1protocol	IEC103
COM1baudrate	9600
COM1dataBit	8
COM1stopBit	1
COM1parity	none
COM2protocol	IEC103
COM2baudrate	9600
COM2dataBit	8
COM2stopBit	1
COM2parity	none

图 3.17 通讯设置界面 Figure 3.17 Communication setting screen

3.7 控制

3.7 Control

“控制”菜单为出厂前测试装置使用，可对装置进行遥控分闸、遥控合闸及信号复归操作。

The “Ctrl” menu is used to manufacturer to test the device before it leaves the factory. The function includes remote control switch、remote control close、signal revert.

该菜单功能使用时请与制造商联系。

When use the “Ctrl” function, please contact the manufacturer first!

3.8 时间

3.8 Time

“时间”菜单用于修改时钟。如图 3.18，时间设置完成后按“确认”键即修改成功，再按“返回”键返回主菜单。

The menu "Time" is used to set the device clock. The setting method as shown in Figure 2.15, when the clock is set, press the "enter" key and then press the "Esc" key, the set is successful.

3.9 信息

3.9 Information

"信息"菜单可显示本装置基本信息包括装置名称、版本号、校验码、硬件配置生成时间、软件配置生成时间、保护逻辑图生成时间及逻辑图版本号等，如图 3.19 所示。

"Info" menu can display the basic information include Name、Version、Check code、Hardware、software、logic、logic version and so on, as shown in figure 3.19.

装置时间
2013-09-10 14:56:40
2013-09-10 13:56:40

图 3.18 时间设置

Time
2013-09-10 14:56:40
2013-09-10 13:56:40

装置信息
AM5-T
版本号: 1.05
校验码: 0x11ae
硬件配置:
2013-09-10_13:42:34
软件配置:
2013-09-10_13:42:38
逻辑图版本: 1.04
2013-09-10_15:50:46

图 3.19 装置信息

Setting
AM5-T
版本号: 1.05
校验码: 0x11ae
硬件配置:
2013-09-10_13:42:34
软件配置:
2013-09-10_13:42:38
保护逻辑图: 1.04
2013-09-10_15:50:46

Figure 3.18 Time setting Figure 3.19 Device information

第四章 装置安装及接线

Chapter 4 Installation and Application

1 安装方法

1 Installation

装置采用面板嵌入式安装，首先在屏体面上按开孔尺寸开孔，如图 4.1。再将装置按图 4.2 所示放入开孔中，直到装置面板靠住机柜的面板。将支架放置于机柜面板的内部（上下各有一个支架），如图 4.3，旋转 4 个固定螺丝，使装置牢固固定在机柜面板上，最后盖上 4 个翻盖即可。（翻盖上方有小缺口，拆卸时需用一字螺丝刀插入小缺口将翻盖取下。）

The installation method shown as figure 4.1, 4.2 and 4.3.

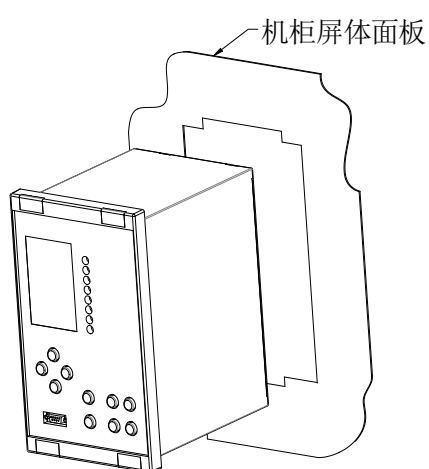


图 4.1
Fig 4.1

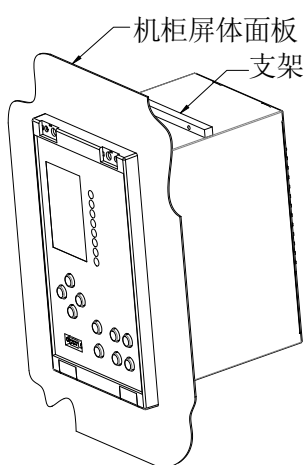


图 4.2
Fig 4.2

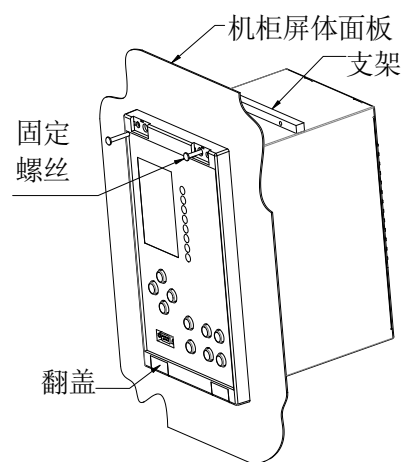


图 4.3
Fig 4.3

2 开孔尺寸

2 Outlines

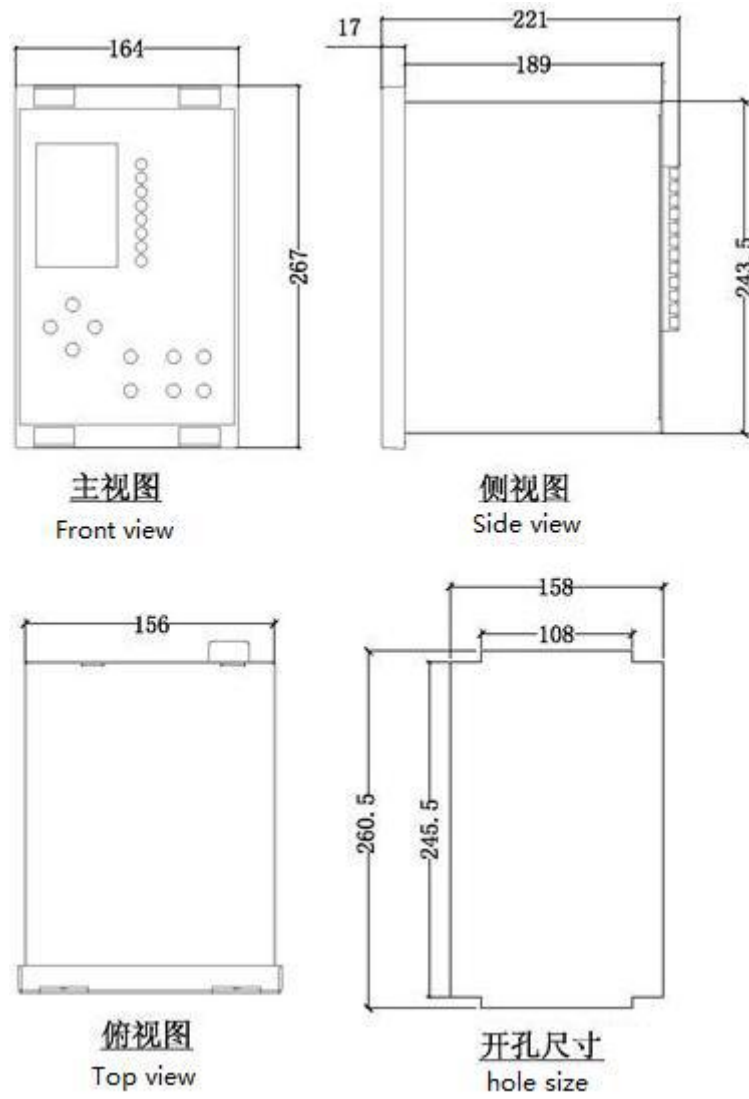


图 4.4 安装尺寸
Fig 4.4 Outlines

3 接线方法

3 Connection method

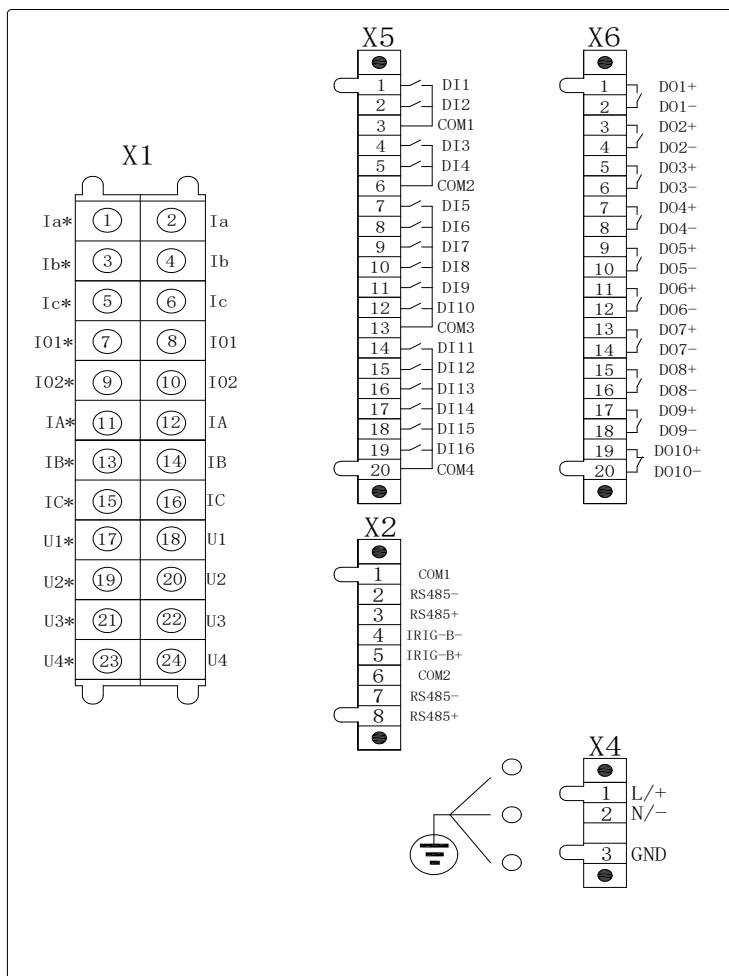


图 4.5 装置电气接线图
Fig 4.5 Connection method

附录 A 装置出厂默认定值表

Accessories A Setting Value

AM5-F 定值表				
AM5-F Setting value				
保护名称 Protection Function	定值名称 Value Name	默认值 Default	范围 Range	备注 Notice
	CT 变比 CT	10	0.1~9999	
	PT 变比 PT	100	0.1~9999	
	一次电压显示 U Unit	0	0~1	kV; V
	电压接线方式 PT Mode	0	0~1	3PT; 2PT
	电流接线方式 CT Mode	0	0~1	3CT; 2CT
	默认延时 Default delay	0s	0~0.04	
	跳闸展宽 Tripping pulse	0.3s	0~1	
	低压阈值 U. Less	15V	0~200	
	低压定值 U. Under	70V	0~200	
过流一段 3I>>>	过流一段投退 E. 3I>>>	0	0~1	退出; 投入 No; Yes
	一段带方向 E. 3I>>>.D	0	0~2	不带方向; 指向线路; 指向母线 OFF; Line; Bus
	一段经低压 E. 3I>>>.U	0	0~1	退出; 投入 No; Yes
	过流一段定值 3I>>>	10A	0.04~75	
	过流一段延时 3I>>>.T	0s	0~60	
过流二段 3I>>	过流二段投退 E. 3I>>	0	0~1	退出; 投入 No; Yes
	二段带方向 E. 3I>>.D	0	0~2	不带方向; 指向线路; 指向母线 OFF; Line; Bus
	二段经低压 E. 3I>>.U	0	0~1	退出; 投入 No; Yes

	过流二段定值 3I>>	7.5A	0.04~75	
	过流二段延时 3I>>.T	0.2s	0~60	
过流三段 3I>	过流三段投退 E.3I>	0	0~1	退出;投入 No;Yes
	过流三段方式 E.3I>.M	0	0~1	告警;跳闸 Alarm;Trip
	三段带方向 E.3I>.D	0	0~2	不带方向;指向线路;指向母线 OFF;Line;Bus
	三段经低压 E.3I>.U	0	0~1	退出;投入 No;Yes
	过流三段定值 3I>	7A	0.04~75	
	过流三段延时 3I>.T	0.5s	0~60	
反时限过流 Inver.Time I>	反时限过流投退 E.I>.Inv	0	0~1	退出;投入 No;Yes
	反时限经低压 E.I>.Inv.U	0	0~1	退出;投入 No;Yes
	反时限启动电流 I>.Inv	6A	0.04~75	
	反时限时间系数 I>.Inv.K	0.1s	0~100	
	反时限曲线类型 I>.Inv.X	0	0~2	一般;非常;极端 S1;S2;S3
过负荷 Overload	过负荷投退 E.I>Lo	0	0~1	退出;投入 No;Yes
	过负荷方式 E.I>Lo.M	0	0~1	告警;跳闸 Alarm;Trip
	过负荷定值 I>Lo	6.5A	0.04~75	
	过负荷延时 I>Lo.T	1s	0~999	
后加速过流 PostAcceleratingI>	后加速过流投退 E.I>P	0	0~1	退出;投入 No;Yes
	后加速经低压 E.I>P.U	0	0~1	退出;投入 No;Yes
	后加速过流定值 I>P	6.5A	0.04~75	
	后加速过流延时 I>P.T	0s	0~60	

I01 过流一段 I01>>>	I01 过流一段投退 E. I01>>>	0	0~1	退出; 投入 No;Yes
	I01 一段定值 I01>>>	10A	0.04~75	
	I01 一段延时 I01>>>.T	5s	0~60	
I01 过流二段 I01>>	I01 过流二段投退 E. I01>>	0	0~1	退出; 投入 No;Yes
	I01 二段方式 E. I01>>.M	0	0~1	告警; 跳闸 Alarm;Trip
	I01 二段定值 I01>>	9A	0.04~75	
	I01 二段延时 I01>>.T	10s	0~60	
I01 反时限 Inver.Time I01>	I01 反时限投退 E. I01. Inv	0	0~1	退出; 投入 No;Yes
	I01 反时限启动值 I01. Inv	6A	0.04~75	
	I01 反时限系数 I01. Inv.K	0.1s	0~100	
	I01 反时限曲线 I01. Inv.X	0	0~2	一般; 非常; 极端 S1;S2;S3
I01 后加速 PostAcceleratingI01>	I01 后加速投退 E. I01>P	0	0~1	退出; 投入 No;Yes
	I01 后加速方式 E. I01>P.M	0	0~1	告警; 跳闸 Alarm;Trip
	I01 后加速定值 I01>P	1A	0.04~75	
	I01 后加速延时 I01>P.T	0s	0~60	
PT 断线告警 PT break	PT 断线告警投退 E. PtBr. A	0	0~1	退出; 投入 No;Yes
	PT 断线告警延时 PtBr. T	10s	0~999	
	PT 断线负序电压 U2. Pt	35V	0~200	
	无压定值 U. None	15V	0~200	
	无流定值 I. None	0.2A	0.04~75	
控故障告警 ControlFailure Alarm	控故障告警投退 E. CB. A	0	0~1	退出; 投入 No;Yes
	控故障告警延时	10s	0~999	

	CB. A. T			
低频减载 Under-frequency Protection	低频减载投退 E. UnderFr.	0	0~1	退出; 投入 No;Yes
	低压闭锁 E. UnderFr. U	0	0~1	退出; 投入 No;Yes
	欠流闭锁 E. UnderFr. I	0	0~1	退出; 投入 No;Yes
	滑差闭锁 E. UnderFr. dHz.	0	0~1	退出; 投入 No;Yes
	低频减载定值 UnderFr.	49Hz	45~60	
	低频减载延时 UnderFr. T	3s	0~60	
	滑差闭锁值 dHz. B	0.1Hz/s	0.01~100	
	欠流闭锁值 I. B	5A	0.04~75	
	低压闭锁值 U. B	50V	0~200	
重合闸 Auto-reclosure	重合闸投退 E. Reclose	0	0~1	退出; 投入 No;Yes
	重合闸延时 Reclose. T	5s	0~999	
	重合闸方式 Reclose. X	0	0~1	不检; 检无压 Not Check;Check
	重合闸充电延时 Rec. C. T	15s	0~999	
	保护重合返回延时 T. R. T	30s	0~999	
	不对应重合投退 E. nonP.	1	0~1	退出; 投入 No;Yes
失压保护 Loss Voltage Protect	失压保护投退 E. LVP	0	0~1	退出; 投入 No;Yes
	失压方式 E. LVP. M	0	0~1	告警; 跳闸 Alarm;Trip
	无流闭锁投退 E. LVP. I. B	0	0~1	退出; 投入 No;Yes
	失压保护定值 U. LVP	70V	0~200	
	失压保护延时 LVP. T	5s	0~60	
过电压保护 Over Voltage Protect	过电压保护投退 E. OVP	0	0~1	退出; 投入 No;Yes

	过电压方式 E. OVP. M	0	0~1	告警; 跳闸 Alarm; Trip
	过电压保护定值 U. OVP	120V	0~200	
	过电压保护延时 OVP. T	5s	0~60	
零序过电压保护 U0. Over Voltage Protect	零序过电压投退 E. U0. OVP	0	0~1	退出; 投入 No; Yes
	零序过电压方式 E. U0. OVP. M	0	0~1	告警; 跳闸 Alarm; Trip
	零序过电压定值 U0. OVP	20V	0~200	
	零序过电压保护延时 U0. OVP. T	5s	0~60	
逆功率保护 Reverse-power Protection	逆功率保护投退 E. RP	0	0~1	退出; 投入 No; Yes
	逆功率保护定值 RP	0	0~ 10000000000	
	逆功率保护延时 RP. T	0	0~99	
高频保护 Over Frequency Protection	高频保护投退 E. OF	0	0~1	退出; 投入 No; Yes
	高频保护定值 OF	50Hz	45~60	
	高频保护延时 OF. T	5s	0~999	
I02 过流一段 I02>>>	I02 一段投退 E. I02>>>	0	0~1	退出; 投入 No; Yes
	I02 一段定值 I02>>>	10A	0.04~75	
	I02 一段延时 I02>>>. T	5s	0~60	
I02 过流二段 I02>>	I02 二段投退 E. I02>>	0	0~1	退出; 投入 No; Yes
	I02 二段+ 2 +3 方式 E. I02>>. M	0	0~1	
	I02 二段定值 I02>>	9A	0.04~75	
	I02 二段延时 I02>>. T	10s	0~60	
I02 反时限	I02 反时限投退	0	0~1	退出; 投入

Inver. Time I02>	E. I02. Inv			No;Yes
	I02 反时限启动值 I02. Inv	6A	0.04~75	
	I02 反时限系数 I02. Inv. K	0.1s	0~100	
	I02 反时限曲线 I02. Inv. X	0	0~2	一般; 非常; 极端 S1;S2;S3
I02 后加速 PostAcceleratingI02>	I02 后加速投退 E. I02>P	0	0~1	退出; 投入 No;Yes
	I02 后加速方式 E. I02>P. M	0	0~1	告警; 跳闸 Alarm;Trip
	I02 后加速定值 I02>P	1A	0.04~75	
	I02 后加速延时 I02>P. T	0s	0~60	
非电量 1 保护 Non-electric1 protection	非电量 1 投退 E. Non-e11	0	0~1	退出; 投入 No;Yes
	非电量 1 方式 E. Non-e11. M	0	0~1	告警; 跳闸 Alarm;Trip
	非电量 1 延时 Non-e11. T	2s	0~999	
非电量 2 保护 Non-electric2 protection	非电量 2 投退 E. Non-e12	0	0~1	退出; 投入 No;Yes
	非电量 2 方式 E. Non-e12. M	0	0~1	告警; 跳闸 Alarm;Trip
	非电量 2 延时 Non-e12. T	2s	0~999	
FC 配合的过流闭锁功能 FC Block	FC 闭锁投退 E. FCBlock	0	0~1	退出; 投入 No;Yes
	FC 闭锁电流定值 FCB. I	10A	0.04~75	
	FC 闭锁延时 FCB. T	5s	0~60	
二次谐波闭锁 Second Harmonic Block	二次谐波闭锁投退 E. SHB.	0	0~1	
	二次谐波闭锁定值 SHB. I	15%	0~100	
	弹簧未储能延时 Sp. En. D.	0s	0~999	
	断路器动作时间 Cir. Br. T	0.3s	0~999	

AM5-T 定值表 Setting value				
保护名称 Protection Function	定值名称 Value Name	默认值 Default	范围 Range	备注 Notice
	CT变比 CT	10	0.1~9999	
	PT变比 PT	100	0.1~9999	
	电压接线方式 PT Mode	0	0~1	3PT; 2PT
	电流接线方式 CT Mode	0	0~1	3CT; 2CT
	一次电压显示 U Unit	0	0~1	kV; V
	跳闸展宽 Tripping pulse	0.3s	0~1	
	低压阈值 U. Less	15V	1~200	
	低电压定值 U. Under	70V	1~200	
	复合电压负序定值 U2	35V	1~200	
过流一段 3I>>>	过流一段投退 E. 3I>>>	0	0~1	退出; 投入 No; Yes
	一段经复压 E. 3I>>>. U2	0	0~1	退出; 投入 No; Yes
	过流一段定值 3I>>>	10A	0.04~75	
	过流一段延时 3I>>>. T	0s	0~60	
过流二段 3I>>	过流二段投退 E. 3I>>	0	0~1	退出; 投入 No; Yes
	二段经复压 E. 3I>>. U2	0	0~1	退出; 投入 No; Yes
	过流二段定值 3I>>	7.5A	0.04~75	
	过流二段延时 3I>>. T	1s	0~60	
过流三段 3I>	过流三段投退 E. 3I>	0	0~1	退出; 投入 No; Yes

	过流三段方式 E. 3I>. M	0	0~1	告警；跳闸 Alarm;Trip
	三段经复压 E. 3I>. U2	0	0~1	退出；投入 No;Yes
	过流三段定值 3I>	7A	0.04~75	
	过流三段延时 3I>. T	2s	0~60	
反时限过流 Inver. Time I>	反时限过流投退 E. I>. Inv	0	0~1	退出；投入 No;Yes
	反时限经复压 E. I>. InvU2	0	0~1	退出；投入 No;Yes
	反时限启动电流 I>. Inv	6A	0.04~75	
	反时限时间系数 I>. Inv. K	0.1s	0~100	
	反时限曲线类型 I>. Inv. X	0	0~2	一般；非常；极端 S1;S2;S3
过负荷保护 Overload Alarm	过负荷投退 E. I>Lo	0	0~1	退出；投入 No;Yes
	过负荷方式 E. I>Lo. M	0	0~1	告警；跳闸 Alarm;Trip
	过负荷定值 I>Lo	6.5A	0.04~75	
	过负荷延时 I>Lo. T	1s	0~999	
I01 过流一段 I01>>>	I01 一段投退 E. I01>>>	0	0~1	退出；投入 No;Yes
	I01 一段定值 I01>>>	10A	0.04~75	
	I01 一段延时 I01>>>. T	5s	0~60	
I01 过流二段 I01>>	I01 二段投退 E. I01>>	0	0~1	退出；投入 No;Yes
	I01 二段方式 E. I01>>. M	0	0~1	告警；跳闸 Alarm;Trip
	I01 二段定值 I01>>	9A	0.04~75	
	I01 二段延时	10s	0~60	

	I01>>. T			
I01 反时限过流 Inver.Time I01>	I01 反时限投退 E. I01. Inv	0	0~1	退出; 投入 No;Yes
	I01 反时限启动值 I01. Inv	6A	0.04~75	
	I01 反时限系数 I01. Inv. K	0.1s	0~100	
	I01 反时限曲线 I01. Inv. X	0	0~2	一般; 非常; 极端 S1;S2;S3
PT 断线告警 PT break	PT 断线告警投退 E. PtBr. A	0	0~1	退出; 投入 No;Yes
	PT 断线告警延时 PtBr. T	5s	0~999	
	无压定值 U. None	15V	1~200	
	无流定值 I. None	0.2A	0.04~75	
	PT 断线负序电压 U2. Pt	35V	1~200	
控故障告警 ControlFailure Alarm	控故障告警投退 E. CB. A	0	0~1	退出; 投入 No;Yes
	控故障告警延时 CB. A. T	10s	0~999	
轻瓦斯告警 LightGas alarm	轻瓦斯告警投退 E. LGas. A	0	0~1	退出; 投入 No;Yes
	轻瓦斯告警延时 LGas. T	5s	0~999	
重瓦斯跳闸 HeavyGastrip	重瓦斯跳闸投退 E. SGas. T	0	0~1	退出; 投入 No;Yes
	重瓦斯跳闸延时 SGas. T	5s	0~60	
压力释放保护 Pressure Relief Protection	压力释放投退 E. Pre. Re	0	0~1	退出; 投入 No;Yes
	压力释放方式 E. Pre. Re. M	0	0~1	告警; 跳闸 Alarm;Trip
	压力释放延时 Pre. Re. T	5s	0~60	
高温告警	高温告警投退	0	0~1	退出; 投入

High Temperation	E. OTem. A			No;Yes
	高温告警延时 OTem. T	5s	0~999	
超温跳闸 Over Temperation	超温跳闸投退 E. HTem. T	0	0~1	退出; 投入 No;Yes
	超温跳闸延时 HTem. T	5s	0~60	
变压器门开保护 Transformer door opening protection	门开投退 E. DoOp.	0	0~1	退出; 投入 No;Yes
	门开方式 E. DoOp. M	0	0~1	告警; 跳闸 Alarm;Trip
	门开延时 DoOp. T	5s	0~60	
温控器故障保护 Thermostat failure protection	温控故障投退 E. Th. Fa.	0	0~1	退出; 投入 No;Yes
	温控故障方式 E. Th. Fa. M	0	0~1	告警; 跳闸 Alarm;Trip
	温控故障延时 Th. Fa. T	5s	0~60	
非电量保护 Non-electric protection	非电量投退 E. Non-el	0	0~1	退出; 投入 No;Yes
	非电量方式 E. Non-el. M	0	0~1	告警; 跳闸 Alarm;Trip
	非电量延时 Non-el. T	2s	0~999	
I02 过流一段 I02>>>	I02 一段投退 E. I02>>>	0	0~1	退出; 投入 No;Yes
	I02 一段定值 I02>>>	10A	0.04~75	
	I02 一段延时 I02>>>. T	5s	0~60	
I02 过流二段 I02>>	I02 二段投退 E. I02>>	0	0~1	退出; 投入 No;Yes
	I02 二段方式 E. I02>>. M	0	0~1	告警; 跳闸 Alarm;Trip
	I02 二段定值 I02>>	9A	0.04~75	
	I02 二段延时 I02>>. T	10s	0~60	
I02 反时限过流 Inver. Time I02>	I02 反时限投退 E. I02. Inv	0	0~1	退出; 投入 No;Yes

	I02 反时限启动值 I02. Inv	6A	0.04~75	
	I02 反时限系数 I02. Inv. K	0.1s	0~100	
	I02 反时限曲线 I02. Inv. X	0	0~2	一般；非常；极端 S1;S2;S3
FC 配合的过流闭锁功能 FC Block	FC 闭锁投退 E. FCBlock	0	0~1	退出；投入 No;Yes
	FC 闭锁电流定值 FCB. I	10A	0.04~75	
	FC 闭锁延时 FCB. T	5s	0~60	
二次谐波闭锁 Second Harmonic Block	二次谐波闭锁投退 E. SHB.	0	0~1	
	二次谐波闭锁定值 SHB. I	15%	0~100	
	弹簧未储能延时 Sp. En. D.	0s	0~999	
	断路器动作时间 Cir. Br. T	0.3s	0~999	

AM5-M 定值表 AM5-M Setting value				
保护名称 Protection Function	定值名称 Value Name	默认值 Default	范围 Range	备注 Notice
	CT 变比 CT	10	0.1~9999	
	PT 变比 PT	100	0.1~9999	
	电压接线方式 PT mode	0	0~1	3PT; 2PT
	电流接线方式 CT Mode	0	0~1	3CT; 2CT
	一次电压显示 U Unit	0	0~1	
	额定电流一次值 Ie1	100A	0.04~9999	
	电动机额定启动时间 Te	5s	0~9999	
	启动延时 Start Delay	0.1s	0~1	

	跳闸展宽 Tripping pulse	0.3s	0~1	
过流一段 3I>>>	过流一段投退 E. 3I>>>	0	0~1	退出; 投入 No;Yes
	启动一段定值 3I>>>.S	30A	0.04~75	
	启动一段延时 3I>>>.Ts	0s	0~60	
	运行一段定值 3I>>>.R	15A	0.04~75	
	运行一段延时 3I>>>.Tr	0s	0~60	
过流二段 3I>>	过流二段投退 E. 3I>>	0	0~1	退出; 投入 No;Yes
	过流二段定值 3I>>	2A	0.04~75	
	过流二段延时 3I>>.T	2s	0~60	
反时限过流 Inver. Time I>	反时限过流投退 E. I>. Inv	0	0~1	退出; 投入 No;Yes
	反时限启动电流 I>. Inv	6A	0.04~75	
	反时限时间系数 I>. Inv. K	0.1s	0~100	
	反时限曲线类型 I>. Inv. X	0	0~2	一般; 非常; 极端 S1;S2;S3
过负荷保护 Overload Alarm	过负荷投退 E. I>Lo	0	0~1	退出; 投入 No;Yes
	过负荷方式 E. I>Lo. M	0	0~1	告警; 跳闸 Alarm;Trip
	过负荷定值 I>Lo	6.5A	0.04~75	
	过负荷延时 I>Lo. T	1s	0~999	
启动时间过长 StartOutTime	启动超时投退 E. SoutT	0	0~1	退出; 投入 No;Yes
	启动超时定值 SoutT. I	1.125	0.04~100	
堵转保护 StallTrip	堵转保护投退 E. Stall	0	0~1	退出; 投入 No;Yes
	堵转电流定值 Stall. I	6.5A	0.04~75	

	堵转保护延时 Stall. T	5s	0~60	
热过载 OverHeat	热过载投退 E. OverHeat	0	0~1	退出; 投入 No;Yes
	告警百分比 Heat. Al. P	70%	0~100	
	跳闸百分比 Heat. Tr. P	100%	0~200	
	发热时间常数 HeatPro. K	15min	0~100	
	散热时间常数 HeatEmi. K	30min	0~300	
	重启动过热闭锁值 HeatRe	50%	0~100	
	错相保护 Staggered Phase Protection	错相保护投退 E. Ph. Se.	0	0~1
线电压高定值 LiV. HSet.		120V	0~200	
线电压低定值 LiV. LSet.		70V	0~200	
正序电压比例 U1 Ratio		30%	0~100	
负序电压比例 U2 Ratio		50%	0~100	
错相保护延时 Ph. Se. T		0s	0~100	
电压不平衡保护 Unbalance Voltage Protection	电压不平衡投退 E. Unb. V	0	0~1	退出; 投入 No;Yes
	电压不平衡度 Unb. V. R.	20%	0~100	
	电压不平衡值 Unb. V	1V	0~200	
	电压不平衡延时 Unb. V. T	0.03s	0~100	
电流不平衡保护 Unbalance Current Protection	电流不平衡投退 E. Unb. I	0	0~1	退出; 投入 No;Yes
	电流不平衡度 Unb. I. R.	30%	0~100	
	电流不平衡延时 Unb. I. T	0.03s	0~100	
I01 过流一段 I01>>>	I01 一段投退 E. I01>>>	0	0~1	退出; 投入 No;Yes
	I01 一段定值	10A	0.04~75	

	I01>>>			
	I01 一段延时 I01>>>. T	5s	0~60	
I01 过流二段 I01>>	I01 二段投退 E. I01>>	0	0~1	退出；投入 No;Yes
	I01 二段方式 E. I01>>. M	0	0~1	告警；跳闸 Alarm;Trip
	I01 二段定值 I01>>	9A	0.04~75	
	I01 二段延时 I01>>. T	10s	0~60	
I01 反时限过流 Inver. Time I01>	I01 反时限投退 E. I01. Inv	0	0~1	退出；投入 No;Yes
	I01 反时限启动值 I01. Inv	6A	0.04~75	
	I01 反时限系数 I01. Inv. K	0.1s	0~100	
	I01 反时限曲线 I01. Inv. X	0	0~2	一般；非常；极端 S1;S2;S3
负序过流一段 I2>>>	负序一段投退 E. I2>>>	0	0~1	退出；投入 No;Yes
	负序一段定值 I2>>>	10A	0.04~75	
	负序一段延时 I2>>>. T	5s	0~60	
负序过流二段 I2>>	负序二段投退 E. I2>>	0	0~1	退出；投入 No;Yes
	负序二段方式 E. I2>>. M	0	0~1	告警；跳闸 Alarm;Trip
	负序二段定值 I2>>	9A	0.04~75	
	负序二段延时 I2>>. T	10s	0~999	
负序反时限 I2. Inv. Tr	负序反时限投退 E. I2>Inv	0	0~1	退出；投入 No;Yes
	负序反时限电流 I2>Inv	6A	0.04~75	
	负序反时限系数 I2>Inv. K	0.1s	0~100	
	负序反时限曲线 I2>Inv. X	0	0~2	一般；非常；极端 S1;S2;S3
低电压保护	低电压保护投退	0	0~1	退出；投入

Loss Voltage Protection	E. LVP			No;Yes
	低电压方式 E. LVP. M	0	0~1	告警; 跳闸 Alarm; Trip
	低电压定值 U. LVP	70V	0~200	
	低电压延时 LVP. T	5s	0~60	
	无流闭锁投退 E. LVP. I. B	0	0~1	退出; 投入 No; Yes
	无流定值 I. None	0.2A	0.04~75	
过电压保护 Over Voltage Protection	过电压保护投退 E. OVP	0	0~1	退出; 投入 No; Yes
	过电压方式 E. OVP. M	0	0~1	告警; 跳闸 Alarm; Trip
	过电压保护定值 U. OVP	120V	0~200	
	过电压保护延时 OVP. T	5s	0~60	
零序过压保护 U0 Over Voltage Protection	零序过压投退 E. U0. OVP	0	0~1	退出; 投入 No; Yes
	零序过压方式 E. U0. OVP. M	0	0~1	告警; 跳闸 Alarm; Trip
	零序过压定值 U0. OVP	20V	0~200	
	零序过压保护延时 U0. OVP. T	5s	0~60	
PT 断线告警 PT BreakAla.	PT 断线告警投退 E. PtBr. A	0	0~1	退出; 投入 No; Yes
	PT 断线告警延时 PtBr. T	10s	0~999	
	无压定值 U. None	15V	0~200	
	PT 断线负序电压 U2. Pt	35V	0~200	
控故障告警 CtrErrorAla.	控故障告警投退 E. CB. A	0	0~1	退出; 投入 No; Yes
	控故障告警延时 CB. A. T	10s	0~999	
I02 过流一段 I02>>>	I02 一段投退 E. I02>>>	0	0~1	退出; 投入 No; Yes
	I02 一段定值	10A	0.04~75	

	I02>>>			
	I02 一段延时 I02>>>. T	5s	0~60	
I02 过流二段 I02>>	I02 二段投退 E. I02>>	0	0~1	退出; 投入 No;Yes
	I02 二段方式 E. I02>>. M	0	0~1	告警; 跳闸 Alarm;Trip
	I02 二段定值 I02>>	9A	0.04~75	
	I02 二段延时 I02>>. T	10s	0~60	
I02 反时限过流 Inver.Time I02>	I02 反时限投退 E. I02. Inv	0	0~1	退出; 投入 No;Yes
	I02 反时限启动值 I02. Inv	6A	0.04~75	
	I02 反时限系数 I02. Inv. K	0.1s	0~100	
	I02 反时限曲线 I02. Inv. X	0	0~2	一般; 非常; 极端 S1;S2;S3
非电量 1 保护 Non-electric1 protection	非电量 1 投退 E. Non-e11	0	0~1	退出; 投入 No;Yes
	非电量 1 方式 E. Non-e11. M	0	0~1	告警; 跳闸 Alarm;Trip
	非电量 1 延时 Non-e11. T	2s	0~60	
非电量 2 保护 Non-electric2 protection	非电量 2 投退 E. Non-e12	0	0~1	退出; 投入 No;Yes
	非电量 2 方式 E. Non-e12. M	0	0~1	告警; 跳闸 Alarm;Trip
	非电量 2 延时 Non-e12. T	2s	0~999	
FC 闭锁 FC Block	FC 闭锁投退 E. FCBlock	0	0~1	退出; 投入 No;Yes
	FC 闭锁电流定值 FCB. I	10A	0.04~75	
	FC 闭锁延时 FCB. T	5s	0~60	
二次谐波闭锁 Second Harmonic Block	二次谐波闭锁投退 E. SHB.	0	0~1	
	二次谐波闭锁定值 SHB. I	15%	0~100	

	弹簧未储能延时 Sp. En. D.	0s	0~999	
	断路器动作时间 Cir. Br. T	0.3s	0~999	
	过量返回系数 Excess R. C	0.950	0.001~2	
	欠量返回系数 Under R. C	1.050	0.001~2	

AM5-C 定值表 AM5-C Setting value				
保护名称 Protection Function	定值名称 Value Name	默认值 Default	范围 Range	备注 Notice
	CT变比 CT	10	0.1~9999	
	PT变比 PT	100	0.1~9999	
	电压接线方式 PT mode	0	0~1	3PT; 2PT
	电流接线方式 CT Mode	0	0~1	3CT; 2CT
	一次电压显示 U Unit	0	0~1	
	跳闸展宽 Tripping pulse	0.3s	0~1	
过流一段 3I>>>	过流一段投退 E. 3I>>>	0	0~1	退出; 投入 No;Yes
	过流一段定值 3I>>>	10A	0.04~75	
	过流一段延时 3I>>>. T	0s	0~60	
过流二段 3I>>	过流二段投退 E. 3I>>	0	0~1	退出; 投入 No;Yes
	过流二段定值 3I>>	7.5A	0.04~75	
	过流二段延时 3I>>. T	1s	0~60	
反时限过流 Inver. Time I>	反时限过流投退 E. I>. Inv	0	0~1	退出; 投入 No;Yes
	反时限启动电流 I>. Inv	6A	0.04~75	
	反时限时间系数	0.1s	0~100	

	I>. Inv. K			
	反时限曲线类型 I>. Inv. X	0	0~2	一般；非常；极端 S1;S2;S3
不平衡电流 Unbalance Current	不平衡电流投退 E. Unb. I	0	0~1	退出；投入 No;Yes
	不平衡电流定值 Unb. I	10A	0.04~75	
	不平衡电流延时 Unb. I. T	1.0s	0~60	
零序过流一段 I01>>>	零序过流一段投退 E. I01>>>	0	0~1	退出；投入 No;Yes
	零序一段定值 I01>>>	10A	0.04~75	
	零序一段延时 I01>>>. T	5s	0~60	
零序过流二段 I01>>	零序过流二段投退 E. I01>>	0	0~1	退出；投入 No;Yes
	零序二段方式 E. I01>>. M	0	0~1	告警；跳闸 Alarm;Trip
	零序二段定值 I01>>	9A	0.04~75	
	零序二段延时 I01>>. T	10s	0~60	
低电压保护 Low Voltage Protection	低电压保护投退 E. LVP	0	0~1	退出；投入 No;Yes
	低电压方式 E. LVP. M	0	0~1	告警；跳闸 Alarm;Trip
	低电压定值 U. LVP	50V	0~200	
	低电压延时 LVP. T	1s	0~60	
	无流闭锁投退 E. LVP. I. B	0	0~1	退出；投入 No;Yes
	无流定值 I. None	1A	0.04~75	
	PT断线闭锁投退 E. PT. B	1	0~1	退出；投入 No;Yes
	合位允许投退 E. CCB On. B	0	0~1	退出；投入 No;Yes
	低电压阈值投退 E. LVThr.	1	0~1	退出；投入 No;Yes
过电压保护	过电压保护投退	0	0~1	退出；投入

Over Voltage Protection	E. OVP			No;Yes
	过电压出口方式 E. OVP. M	0	0~1	告警; 跳闸 Alarm; Trip
	过电压定值 U. OVP	120V	0~200	
	过电压延时 OVP. T	10s	0~60	
不平衡电压保护 Unbalance Voltage Protection	不平衡电压投退 E. Unb. V	0	0~1	退出; 投入 No;Yes
	不平衡电压定值 Unb. V	50V	0~200	
	不平衡电压延时 Unb. V. T	10s	0~60	
零序过压保护 U0 Over Voltage Protection	零序过电压投退 E. U0. OVP	0	0~1	退出; 投入 No;Yes
	零序过压出口方式 E. U0. OVP. M	0	0~1	告警; 跳闸 Alarm; Trip
	零序电压输入 U0 Input	0	0~1	外接零序电压; 自产零序电压 U0; 3U0
	零序过电压定值 U0. OVP	110V	0~200	
	零序过电压延时 U0. OVP. T	10s	0~60	
PT 断线告警 PT BreakAla.	PT 断线告警投退 E. PtBr. A	0	0~1	退出; 投入 No;Yes
	PT 断线告警延时 PtBr. T	10s	0~999	
	PT 断线负序电压 U2. Pt	35V	0~200	
	无压定值 U. None	15V	0~200	
控故障告警 CtrErrorAla.	控故障告警投退 E. CB. A	0	0~1	退出; 投入 No;Yes
	控故障告警延时 CB. A. T	10s	0~999	
非电量 1 保护 Non-electric1 protection	非电量 1 投退 E. Non-e11	0	0~1	退出; 投入 No;Yes
	非电量 1 出口方式 E. Non-e11. M	0	0~1	告警; 跳闸 Alarm; Trip
	非电量 1 延时 Non-e11. T	2s	0~60	

非电量 2 保护 Non-electric2 protection	非电量 2 投退 E. Non-e12	0	0~1	退出; 投入 No;Yes
	非电量 2 出口方式 E. Non-e12. M	0	0~1	告警; 跳闸 Alarm;Trip
	非电量 2 延时 Non-e12. T	2s	0~60	
非电量 3 保护 Non-electric2 protection	非电量 3 投退 E. Non-e13	0	0~1	退出; 投入 No;Yes
	非电量 3 出口方式 E. Non-e13. M	0	0~1	告警; 跳闸 Alarm;Trip
	非电量 3 延时 Non-e13. T	2s	0~999	
FC 闭锁 FC Block	FC 闭锁投退 E. FCBlock	0	0~1	退出; 投入 No;Yes
	FC 闭锁电流定值 FCB. I	10A	0.04~75	
	FC 闭锁延时 FCB. T	5s	0~60	
二次谐波闭锁 Second Harmonic Block	二次谐波闭锁投退 E. SHB.	0	0~1	
	二次谐波闭锁定值 SHB. I	15%	0~100	
	弹簧未储能动作延时 Sp. En. D.	0s	0~999	
	断路器动作时间 Cir. Br. T	0.3s	0~999	

AM5-B 定值表 AM5-B Setting value				
保护名称 Protection Function	定值名称 Value Name	默认值 Default	范围 Range	备注 Notice
	一次图显示方式 Pri. Sys.	2	0~4	方式 0~4 Mode0~4
	一次电压显示 U Unit	0	0~1	kV;V
	PT 变比 PT	100	0.1~9999	
	CT 变比 CT	10	0.1~9999	
	电压接线方式 PT mode	0	0~1	3PT; 2PT
	电流接线方式	0	0~1	3CT; 2CT

	CT Mode			
	跳闸展宽 Tripping pulse	0.3s	0~1	
	1QF 位置 1QF On	8	1~16	
	2QF 位置 2QF On	9	1~16	
	备投判进线电压 E. In. V. C	0	0~1	退出; 投入 OFF; ON
	备投判进线电流 E. In. I. C	0	0~1	退出; 投入 OFF; ON
	备投方式 Spa. Mode	0	0~4	退出 ;分段备投; 进线备投;自适应 备投;联切备投 OFF;Bus. S;Incomi ng. S;Self-adapt. S;JOint Cut.S
	进线 1 备投 E. 1-In. Spa.	0	0~1	退出; 投入 OFF; ON
	进线 2 备投 E. 2-In. Spa.	0	0~1	退出; 投入 OFF; ON
	4路进线电压做备投 4U. S	0	0~1	退出; 投入 OFF; ON
	分合指示灯关联 On OFF. I	0	0~2	分段柜;进线 1 柜; 进线 2 柜 Busbar;1-Incomin g;2-Incoming
	进线 1 电流来源 I1 Source	0	0~2	通道 4; 通道 5; 通 道 1 CH4;CH5;CH1
	进线 2 电流来源 I1 Source	1	0~2	通道 4; 通道 5; 通 道 1 CH4;CH5;CH1
	零流来源 IO Source	0	0~3	自产;外接通道 2; 外接通道 4; 外接通

				道 5 Self-produced; CH2;CH4;CH5
	进线无压定值 In. U. None	10V	0~200	
	母线无压定值 B. U. None	10V	0~200	
	进线有压定值 In. Vo. St. V	20V	0~200	
	母线有压定值 B. Vo. St. V	20V	0~200	
	进线 1 无流定值 I1. None	0.1A	0.04~100	
	进线 2 无流定值 I2. None	0.1A	0.04~100	
	分段充电延时 B. Cha. D	15s	0~60	
	进线 1 充电延时 1-I. C. D	15s	0~60	
	进线 2 充电延时 2-I. C. D	15s	0~60	
	跳进线 1 延时 1-In. T. D.	2s	0~60	
	跳进线 2 延时 2-In. T. D.	2s	0~60	
	跳母联延时 Bus. T. D.	2s	0~60	
	合进线 1 延时 1-In. C. D.	2s	0~60	
	合进线 2 延时 2-In. C. D.	2s	0~60	
	合母联延时 Bus. C. D.	2s	0~60	
	无流定值 I. None	0.1A	0.04~100	

	无压定值 U. None	10V	0~200	
过流一段 3I>>>	过流一段投退 E. 3I>>>	0	0~1	退出; 投入 No; Yes
	过流一段定值 3I>>>	10A	0.04~75	
	过流一段延时 3I>>>. T	0s	0~60	
过流二段 3I>>	过流二段投退 E. 3I>>	0	0~1	退出; 投入 No; Yes
	过流二段定值 3I>>	7.5A	0.04~75	
	过流二段延时 3I>>. T	2s	0~60	
过流三段 3I>	过流三段投退 E. 3I>	0	0~1	退出; 投入 No; Yes
	过流三段方式 3I>. M	0	0~1	告警; 跳闸 Alarm; Trip
	过流三段定值 3I>	7A	0.04~75	
	过流三段延时 3I>. T	2s	0~60	
反时限过流 Inver. Time I>	反时限过流投退 E. I>. Inv	0	0~1	退出; 投入 No; Yes
	反时限启动电流 I>. Inv	6A	0.04~75	
	反时限时间系数 I>. Inv. K	0.1s	0~100	
	反时限曲线类型 I>. Inv. X	0	0~2	一般; 非常; 极端 S1; S2; S3
后加速过流 PostAccelerating I>	后加速过流投退 E. I>P	0	0~1	退出; 投入 No; Yes
	后加速过流定值 I>P	6.5A	0.04~75	
	后加速过流延时 I>P. T	1s	0~60	
母线充电保护 Bus Charge Protection	充电保护投退 E. B. Cha.	0	0~1	退出; 投入 No; Yes
	充电保护电流定值 B. Cha.	5A	0~100	
	充电作用时间 Cha. Ac. T	3s	0~60	

	充电保护延时 B. Cha. T	5s	0~60	
控故障告警 ControlFailure Alarm	控故障告警投退 E. CB. A	0	0~1	退出；投入 No;Yes
	控故障告警延时 CB. A. T	10s	0~999	
PT 断线告警 PT break	PT 断线告警投退 E. PtBr. A	0	0~1	退出；投入 No;Yes
	PT 断线告警延时 PtBr. T	5s	0~999	
I0 一段保护 I0>>>	I0 一段投退 E. I0>>>	0	0~1	退出；投入 No;Yes
	I0 一段定值 I0>>>	10A	0.04~75	
	I0 一段延时 I0>>>T	5s	0~60	
I0 二段保护 I0>>	I0 二段投退 E. I0>>	0	0~1	退出；投入 No;Yes
	I0 二段方式 E. I0>>M	0	0~1	告警；跳闸 Alarm;Trip
	I0 二段定值 I0>>	9A	0.04~75	
	I0 二段延时 I0>>T	10s	0~60	
I0 反时限保护 Inver. Time I0>	I0 反时限投退 E. I01. Inv	0	0~1	退出；投入 No;Yes
	I0 反时限启动值 I01. Inv	6A	0.04~75	
	I0 反时限系数 I01. Inv. K	0.1	0~100	
	I0 反时限曲线 I01. Inv. X	0	0~2	一般；非常；极端 S1;S2;S3
I0 后加速保护 PostAccelerating I0>	I0 后加速投退 E. I01>P	0	0~1	退出；投入 No;Yes
	I0 后加速方式 E. I01>P. M	0	0~1	告警；跳闸 Alarm;Trip
	I0 后加速定值 I01>P	1A	0.04~75	
	I0 后加速延时 I01>P. T	0	0~60	

AM5-DB 定 值 表
AM5-DB Setting value

保护名称 Protection Function	定值名称 Value Name	默认值 Default	范围 Range	备注 Notice
	一次图显示方式 Pri. Sys.	2	0~4	方式 0~4 Mode0~4
	一次电压显示 U Unit	1	0~1	kV;V
	PT 变比 PT	1	0.1~999	
	CT 变比 CT	10	0.1~999	
	跳闸展宽 Tripping pulse	0.15s	0~1	
	1QF 位置 1QF On	8	1~16	
	2QF 位置 2QF On	9	1~16	
	备投判进线电压 E. In. V. C	0	0~1	退出; 投入 OFF; ON
	分段备投投退 E. BusSp. T	0	0~1	退出; 投入 OFF; ON
	进线 1 备投 E. 1-In. Spa.	0	0~1	退出; 投入 OFF; ON
	进线 2 备投 E. 2-In. Spa.	0	0~1	退出; 投入 OFF; ON
	进线无压定值 LossVol.	50V	0~999	
	母线无压定值 LossB. Vol.	50V	0~999	
	进线有压定值 Vol. St. V	50V	0~999	
	母线有压定值 Vol. St. B. V	50V	0~999	
	进线 1 无流定值 1-InLo. C.	0.1A	0~90	
	进线 2 无流定值 2-InLo. C.	0.1A	0~90	
	分段充电延时	15s	0~99	

	B. Cha. D			
	分段充电返回 T B. Cha. R. D	10s	0~99	
	进线 1 充电延时 1-I. C. D	15s	0~99	
	进线 1 充电返回 T 1-I. C. RD	10s	0~99	
	进线 2 充电延时 2-I. C. D	15s	0~99	
	进线 2 充电返回 T 2-I. C. RD	10s	0~99	
	跳进线 1 延时 1-In. T. D.	2s	0~99	
	跳进线 2 延时 2-In. T. D.	2s	0~99	
	跳母联延时 Bus. T. D.	2s	0~99	
	合进线 1 延时 1-In. C. D.	2s	0~99	
	合进线 2 延时 2-In. C. D.	2s	0~99	
	合母联延时 Bus. C. D.	2s	0~99	
过流一段 3I>>>	过流一段投退 E. 3I>>>	0	0~1	退出；投入 No;Yes
	过流一段定值 3I>>>	6A	0~90	
	过流一段延时 3I>>>. T	0s	0~99	
过流二段 3I>>	过流二段投退 E. 3I>>	0	0~1	退出；投入 No;Yes
	过流二段定值 3I>>	5A	0~90	
	过流二段延时 3I>>. T	2s	0~99	
后加速过流 PostAccelerating	后加速过流投退 E. I>P	0	0~1	退出；投入 No;Yes

I>	后加速过流定值 I>P	4A	0~90	
	后加速过流延时 I>P. T	1s	0~99	
控制回路断线 告警 ControlFailure Alarm	控制回路断线投退 E. CB.	0	0~1	退出; 投入 No;Yes
	控制回路断线延时 CB. T	5s	0~99	
PT 断线告警 PT break	母线 PT 断线投退 E. B. PtBr	0	0~1	退出; 投入 No;Yes
	进线 PT 断线投退 E. I. PtBr	0	0~1	退出; 投入 No;Yes
	PT 断线延时 PtBr. T	5s	0~99	
过电压保护 Over Voltage Protection	过电压保护投退 E. OVP	1	0~1	退出; 投入 No;Yes
	过电压出口方式 E. OVP. M	0	0~1	告警; 跳闸 Alarm;Trip
	过电压保护定值 U. OVP	270V	0~999	
	过电压保护延时 OVP. T	0s	0~60	

AM5-U1 定值表 AM5-U1 Setting value				
保护名称 Protection Function	定值名称 Value Name	默认值 Default	范围 Range	备注 Notice
	PT 变比 PT	100	0.1~9999	
	电压接线方式 PT mode	0	0~1	3PT; 2PT
	一次电压显示 U Unit	0	0~1	KV; V
低电压告警 Loss Voltage Alarm	低电压告警投退 E. U. Un. A	0	0~1	退出; 投入 No;Yes
	低电压告警定值 U. Un. A	50V	0~200	
	低电压告警延时 U. Un. A. T	5s	0~999	
	PT 断线闭锁投退 E. PT. B	0	0~1	退出; 投入 No;Yes
	无压定值	15	0~200	

	U. None			
	低电压阈值投退 E. LVThr.	0	0~1	退出；投入 No;Yes
零序过压告警 U0 Over Voltage Alarm	零序过压告警投退 E. O. U0	0	0~1	退出；投入 No;Yes
	零序过压告警定值 O. U0	110V	0~200	
	零序过压告警延时 O. U0. T	10s	0~999	
过电压告警 Over Voltage Alarm	过电压告警投退 E. OVP. A	0	0~1	退出；投入 No;Yes
	过电压告警定值 OVP. A	110V	0~200	
	过电压告警延时 OVP. A. T	10s	0~999	
PT 断线告警 PT BreakAla.	PT 断线告警投退 E. PtBr. A	0	0~1	退出；投入 No;Yes
	PT 断线负序电压 U2. Pt	35V	0~200	
	PT 断线告警延时 PtBr. T	10s	0~999	
自产零序过压告警 3U0 Over Voltage Alarm	3U0 告警投退 E. O. 3U0. A	0	0~1	退出；投入 No;Yes
	3U0 告警定值 O. 3U0. A	110V	0~200	
	3U0 告警延时 O. 3U0. A. T	10s	0~999	

附录 B 遥信量地址表

Accessories B Remote address table

AM5-F 遥信地址表			
AM5-F Remote address table			
地址 Address	遥信功能 Function	长度 Length	备注 Notice
0x0000	装置异常 Unusual	1bit	装置发生异常时, 置 1 Unusual;set 1
0x0001	装置是否有出错记录 Error	1bit	装置有出错记录时, 置 1 Error;set 1
0x0002	装置是否有事件记录 Soe	1bit	装置有事件记录时, 置 1 Soe;set 1
0x0003	保留 Spare		
	。 。 。		
0x0008	合位 CCB On	1bit	16 个遥信量 16 remote signals
0x0009	分位 CCB Off	1bit	遥信量 Remote signal
0x000A	运行位置 Work Posi.	1bit	遥信量 Remote signal
0x000B	试验位置 Test Posi.	1bit	遥信量 Remote signal
0x000C	接地刀闸 GroundSwitch	1bit	遥信量 Remote signal
0x000D	远方指示 Remote	1bit	遥信量 Remote signal
0x000E	弹簧未储能 Discharge	1bit	遥信量 Remote signal
0x000F	手动分闸 ManualTrip	1bit	遥信量 Remote signal
0x0010	手动合闸 ManualClose	1bit	遥信量 Remote signal
0x0011	闭锁重合闸 BlockReclosing	1bit	遥信量 Remote signal
0x0012	非电量 1 Non-elec. 1	1bit	遥信量 Remote signal
0x0013	非电量 2 Non-elec. 2	1bit	遥信量 Remote signal
0x0014	开入 13 DI13	1bit	遥信量 Remote signal
0x0015	开入 14	1bit	遥信量

	DI14		Remote signal
0x0016	开入 15 DI15	1bit	遥信量 Remote signal
0x0017	信号复归 ResetSignal	1bit	遥信量 Remote signal

AM5-T 遥信地址表 AM5-T Remote address table			
地址	功能 Function	长度 Length	备注 Notice
0x0000	装置异常 Unusual	1bit	装置发生异常时, 置 1 Unusual;set 1
0x0001	装置是否有出错记录 Error	1bit	装置有出错记录时, 置 1 Error;set 1
0x0002	装置是否有事件记录 Soe	1bit	装置有事件记录时, 置 1 Soe;set 1
0x0003	保留 Spare		
	。 。 。		
0x0008	合位 CCB On	1bit	16 个遥信量 16 remote signals
0x0009	分位 CCB Off	1bit	遥信量 Remote signal
0x000A	运行位置 Work Posi.	1bit	遥信量 Remote signal
0x000B	试验位置 Test Posi.	1bit	遥信量 Remote signal
0x000C	接地刀闸 GroundSwitch	1bit	遥信量 Remote signal
0x000D	远方指示 Remote	1bit	遥信量 Remote signal
0x000E	弹簧未储能 Discharge	1bit	遥信量 Remote signal
0x000F	轻瓦斯 SlightGas	1bit	遥信量 Remote signal
0x0010	重瓦斯 SevereGas	1bit	遥信量 Remote signal
0x0011	压力释放 PressureRele.	1bit	遥信量 Remote signal
0x0012	高温 OverTemp.	1bit	遥信量 Remote signal
0x0013	超温 HighTemp.	1bit	遥信量 Remote signal

0x0014	变压器门开 DoorOpen	1bit	遥信量 Remote signal
0x0015	温控器故障 Therm. Fa.	1bit	遥信量 Remote signal
0x0016	非电量 Non-elec.	1bit	遥信量 Remote signal
0x0017	信号复归 ResetSignal	1bit	遥信量 Remote signal

AM5-M 遥信地址表 AM5-M Remote address table			
地址 Address	遥信功能 Function	长度 Length	备注 Notice
0x0000	装置异常 Unusual	1bit	装置发生异常时, 置 1 Unusual;set 1
0x0001	装置是否有出错记录 Error	1bit	装置有出错记录时, 置 1 Error;set 1
0x0002	装置是否有事件记录 Soe	1bit	装置有事件记录时, 置 1 Soe;set 1
0x0003	保留 Spare		
	。 。 。		
0x0008	合位 CCB On	1bit	16 个遥信量 16 remote signals
0x0009	分位 CCB Off	1bit	遥信量 Remote signal
0x000A	运行位置 Work Posi.	1bit	遥信量 Remote signal
0x000B	试验位置 Test Posi.	1bit	遥信量 Remote signal
0x000C	接地刀闸 GroundSwitch	1bit	遥信量 Remote signal
0x000D	远方指示 Remote	1bit	遥信量 Remote signal
0x000E	弹簧未储能 Discharge	1bit	遥信量 Remote signal
0x000F	手动分闸 ManualTrip	1bit	遥信量 Remote signal
0x0010	非电量 1 Non-elec. 1	1bit	遥信量 Remote signal
0x0011	非电量 2 Non-elec. 2	1bit	遥信量 Remote signal
0x0012	热复归	1bit	遥信量

	HeatRecovery		Remote signal
0x0013	转速低 Low Speed	1bit	遥信量 Remote signal
0x0014	备用 1 Spare1	1bit	遥信量 Remote signal
0x0015	备用 2 Spare2	1bit	遥信量 Remote signal
0x0016	备用 3 Spare3	1bit	遥信量 Remote signal
0x0017	信号复归 ResetSignal	1bit	遥信量 Remote signal

AM5-C 遥信地址表 AM5-C Remote address table			
地址 Address	遥信功能 Function	长度 Length	备注 Notice
0x0000	装置异常 Unusual	1bit	装置发生异常时, 置 1 Unusual;set 1
0x0001	装置是否有出错记录 Error	1bit	装置有出错记录时, 置 1 Error;set 1
0x0002	装置是否有事件记录 Soe	1bit	装置有事件记录时, 置 1 Soe;set 1
0x0003	保留 Spare		
	。 。 。		
0x0008	合位 CCB On	1bit	16 个遥信量 16 remote signals
0x0009	分位 CCB Off	1bit	遥信量 Remote signal
0x000A	运行位置 Work Posi.	1bit	遥信量 Remote signal
0x000B	试验位置 Test Posi.	1bit	遥信量 Remote signal
0x000C	接地刀闸 GroundSwitch	1bit	遥信量 Remote signal
0x000D	远方指示 Remote	1bit	遥信量 Remote signal
0x000E	弹簧未储能 Discharge	1bit	遥信量 Remote signal
0x000F	手动分闸 ManualTrip	1bit	遥信量 Remote signal
0x0010	手动合闸 ManualClose	1bit	遥信量 Remote signal

0x0011	非电量 1 Non-elec. 1	1bit	遥信量 Remote signal
0x0012	非电量 2 Non-elec. 2	1bit	遥信量 Remote signal
0x0013	非电量 3 Non-elec. 3	1bit	遥信量 Remote signal
0x0014	开入 13 DI13	1bit	遥信量 Remote signal
0x0015	开入 14 DI14	1bit	遥信量 Remote signal
0x0016	开入 15 DI15	1bit	遥信量 Remote signal
0x0017	信号复归 ResetSignal	1bit	遥信量 Remote signal

AM5-B 遥信地址表 AM5-B Remote address table			
地址 Address	遥信功能 Function	长度 Length	备注 Notice
0x0000	装置异常 Unusual	1bit	装置发生异常时, 置 1 Unusual;set 1
0x0001	装置是否有出错记录 Error	1bit	装置有出错记录时, 置 1 Error;set 1
0x0002	装置是否有事件记录 Soe	1bit	装置有事件记录时, 置 1 Soe;set 1
0x0003	保留 Spare		
	。 。 。		
0x0008	断路器合位 CCB On	1bit	16 个遥信量 16 remote signals
0x0009	断路器分位 CCB Off	1bit	遥信量 Remote signal
0x000A	手车工作位置 Work Posi.	1bit	遥信量 Remote signal
0x000B	手车试验位置 Test Posi.	1bit	遥信量 Remote signal
0x000C	闭锁备自投 Bl. SPAS	1bit	遥信量 Remote signal
0x000D	远方指示 Remote	1bit	遥信量 Remote signal
0x000E	弹簧未储能 Discharge	1bit	遥信量 Remote signal
0x000F	1QF 位置	1bit	遥信量

	1QF On		Remote signal
0x0010	2QF 位置 2QF On	1bit	遥信量 Remote signal
0x0011	备自投投入 E. SPAS	1bit	遥信量 Remote signal
0x0012	备投自动复归 E. SPASaR	1bit	遥信量 Remote signal
0x0013	备用 1 Spare1	1bit	遥信量 Remote signal
0x0014	备用 2 Spare2	1bit	遥信量 Remote signal
0x0015	备用 3 Spare3	1bit	遥信量 Remote signal
0x0016	手动合闸 ManualClose	1bit	遥信量 Remote signal
0x0017	信号复归 ResetSignal	1bit	遥信量 Remote signal

AM5-DB 遥信地址表			
AM5-DB Remote address table			
地址 Address	遥信功能 Function	长度 Length	备注 Notice
0x0000	装置异常 Unusual	1bit	装置发生异常时, 置 1 Unusual;set 1
0x0001	装置是否有出错记录 Error	1bit	装置有出错记录时, 置 1 Error;set 1
0x0002	装置是否有事件记录 Soe	1bit	装置有事件记录时, 置 1 Soe;set 1
0x0003	保留 Spare		
	。 。 。		
0x0008	母联合位 CCB On	1bit	16 个遥信量 16 remote signals
0x0009	母联分位 CCB Off	1bit	遥信量 Remote signal
0x000A	备用 1 Spare1	1bit	遥信量 Remote signal
0x000B	备用 2 Spare2	1bit	遥信量 Remote signal
0x000C	闭锁备投 Bl. SPAS	1bit	遥信量 Remote signal
0x000D	远方指示 Remote	1bit	遥信量 Remote signal

0x000E	备用 3 Spare3	1bit	遥信量 Remote signal
0x000F	1QF 位置 1QF On	1bit	遥信量 Remote signal
0x0010	2QF 位置 2QF On	1bit	遥信量 Remote signal
0x0011	备自投投入 E. SPAS	1bit	遥信量 Remote signal
0x0012	备投自动复归 E. SPASaR	1bit	遥信量 Remote signal
0x0013	备用 4 Spare4	1bit	遥信量 Remote signal
0x0014	备用 5 Spare5	1bit	遥信量 Remote signal
0x0015	备用 6 Spare6	1bit	遥信量 Remote signal
0x0016	手动合闸 ManualClose	1bit	遥信量 Remote signal
0x0017	信号复归 ResetSignal	1bit	遥信量 Remote signal

AM5-U1 遥信地址表			
AM5-U1 Remote address table			
地址 Address	遥信功能 Function	长度 Length	备注 Notice
0x0000	装置异常 Unusual	1bit	装置发生异常时, 置 1 Unusual;set 1
0x0001	装置是否有出错记录 Error	1bit	装置有出错记录时, 置 1 Error;set 1
0x0002	装置是否有事件记录 Soe	1bit	装置有事件记录时, 置 1 Soe;set 1
0x0003	保留 Spare		
	。 。 。		
0x0008	备用 1 Spare1	1bit	16 个遥信量 16 remote signals
0x0009	备用 2 Spare2	1bit	遥信量 Remote signal
0x000A	运行位置 Work Posi.	1bit	遥信量 Remote signal
0x000B	试验位置 Test Posi.	1bit	遥信量 Remote signal
0x000C	备用 3	1bit	遥信量

	Spare3		Remote signal
0x000D	备用 4 Spare4	1bit	遥信量 Remote signal
0x000E	备用 5 Spare5	1bit	遥信量 Remote signal
0x000F	备用 6 Spare6	1bit	遥信量 Remote signal
0x0010	备用 7 Spare7	1bit	遥信量 Remote signal
0x0011	备用 8 Spare8	1bit	遥信量 Remote signal
0x0012	备用 9 Spare9	1bit	遥信量 Remote signal
0x0013	备用 10 Spare10	1bit	遥信量 Remote signal
0x0014	备用 11 Spare11	1bit	遥信量 Remote signal
0x0015	备用 12 Spare12	1bit	遥信量 Remote signal
0x0016	备用 13 Spare13	1bit	遥信量 Remote signal
0x0017	信号复归 ResetSignal	1bit	遥信量 Remote signal

附录 C 遥测量地址表

Accessories C Telemetry address table

AM5-F 遥测量地址表 AM5-F Telemetry address table			
地址 Address	功能 Function	长度 Length	备注 Notice
0x0000	Ia	32bit	保护电流 Ia
0x0001			Protection current Ia
0x0002	Ib	32bit	保护电流 Ib
0x0003			Protection current Ib
0x0004	Ic	32bit	保护电流 Ic
0x0005			Protection current Ic
0x0006	I01	32bit	零序电流 I01
0x0007			Zero sequence current I01
0x0008	I02	32bit	零序电流 I02
0x0009			Zero sequence current I02
0x000A	IA	32bit	测量电流 IA
0x000B			Measuring current IA
0x000C	IB	32bit	测量电流 IB
0x000D			Measuring current IB
0x000E	IC	32bit	测量电流 IC
0x000F			Measuring current IC
0x0010	UAB	32bit	线电压 UAB
0x0011			Line voltage UAB
0x0012	UBC	32bit	线电压 UBC
0x0013			Line voltage UBC
0x0014	UCA	32bit	线电压 UCA
0x0015			Line voltage UCA
0x0016	U0	32bit	零序电压 U0
0x0017			Zero sequence voltage U0
0x0018	U1	32bit	正序电压
0x0019			Positive sequence voltage
0x001A	U2	32bit	负序电压
0x001B			Negative sequence voltage
0x001C	Fr	32bit	频率
0x001D			Frequency
0x001E	P	32bit	有功功率
0x001F			Active power
0x0020	PF	32bit	功率因数
0x0021			Power factor
0x0022	P0	32bit	有功功率绝对值

0x0023			Absolute value of active power
0x0024	Q	32bit	无功功率
0x0025			Reactive power
0x0026	3U0	32bit	自产零序电压
0x0027			Self-produced zero-sequence voltage
0x0028	S	32bit	视在功率
0x0029			Apparent power
0x002A	Ep	32bit	有功电能
0x002B			Active electric energy
0x002C	Eq	32bit	无功电能
0x002D			Reactive electric energy
0x002E	Es	32bit	视在电能
0x002F			Apparent electric energy
0x0030	Ia_H2	32bit	保护电流 Ia 二次谐波
0x0031			Ia Second harmonic
0x0032	Ib_H2	32bit	保护电流 Ib 二次谐波
0x0033			Ib Second harmonic
0x0034	Ic_H2	32bit	保护电流 Ic 二次谐波
0x0035			Ic Second harmonic
0x0036	QFcnt	32bit	断路器分合次数
0x0037			Action times of circuit breaker
0x0038	df	32bit	频率变化率
0x0039			Frequency change rate
0x003A	Ep+	32bit	正向有功电度
0x003B			
0x003C	Ep-	32bit	反向有功电度
0x003D			
0x003E	Eq+	32bit	正向无功电度
0x003F			
0x0040	Eq-	32bit	反向无功电度
0x0041			
0x0042	Eq_L	32bit	感性无功
0x0043			
0x0044	Eq_C	32bit	容性无功
0x0045			
0x0046	Eq I	32bit	I 象限无功
0x0047			
0x0048	Eq II	32bit	II 象限无功
0x0049			
0x004A	EqIII	32bit	III象限无功
0x004B			
0x004C	EqIV	32bit	IV象限无功

0x004D			
--------	--	--	--

AM5-T 遥测量地址表 AM5-T Telemetry address table			
地址 Address	功能 Function	长度 Length	备注 Notice
0x0000	Ia	32bit	保护电流 Ia
0x0001			Protection current Ia
0x0002	Ib	32bit	保护电流 Ib
0x0003			Protection current Ib
0x0004	Ic	32bit	保护电流 Ic
0x0005			Protection current Ic
0x0006	I01	32bit	零序电流 I01
0x0007			Zero sequence current I01
0x0008	I02	32bit	零序电流 I02
0x0009			Zero sequence current I02
0x000A	IA	32bit	测量电流 IA
0x000B			Measuring current IA
0x000C	IB	32bit	测量电流 IB
0x000D			Measuring current IB
0x000E	IC	32bit	测量电流 IC
0x000F			Measuring current IC
0x0010	UAB	32bit	线电压 UAB
0x0011			Line voltage UAB
0x0012	UBC	32bit	线电压 UBC
0x0013			Line voltage UBC
0x0014	UCA	32bit	线电压 UCA
0x0015			Line voltage UCA
0x0016	U0	32bit	零序电压 U0
0x0017			Zero sequence voltage U0
0x0018	Fr	32bit	频率
0x0019			Frequency
0x001A	P	32bit	有功功率
0x001B			Active power
0x001C	PF	32bit	功率因数
0x001D			Power factor
0x001E	Q	32bit	无功功率
0x001F			Reactive power
0x0020	U1	32bit	正序电压
0x0021			Positive sequence voltage
0x0022	U2	32bit	负序电压
0x0023			Negative sequence voltage

0x0024	S	32bit	视在功率
0x0025			Apparent power
0x0026	Ep	32bit	有功电能
0x0027			Active electric energy
0x0028	Eq	32bit	无功电能
0x0029			Reactive electric energy
0x002A	Es	32bit	视在电能
0x002B			Apparent electric energy
0x002C	Ia_H2	32bit	保护电流 Ia 二次谐波
0x002D			Ia Second harmonic
0x002E	Ib_H2	32bit	保护电流 Ib 二次谐波
0x002F			Ib Second harmonic
0x0030	Ic_H2	32bit	保护电流 Ic 二次谐波
0x0031			Ic Second harmonic
0x0032	QFcnt	32bit	断路器分合次数
0x0033			Action times of circuit breaker
0x0034	df	32bit	频率变化率
0x0035			Frequency change rate
0x0036	Ep+	32bit	正向有功电度
0x0037			
0x0038	Ep-	32bit	反向有功电度
0x0039			
0x003A	Eq+	32bit	正向无功电度
0x003B			
0x003C	Eq-	32bit	反向无功电度
0x003D			
0x003E	Eq_L	32bit	感性无功
0x003F			
0x0040	Eq_C	32bit	容性无功
0x0041			
0x0042	Eq I	32bit	I 象限无功
0x0043			
0x0044	Eq II	32bit	II 象限无功
0x0045			
0x0046	EqIII	32bit	III象限无功
0x0047			
0x0048	EqIV	32bit	IV象限无功
0x0049			

AM5-M 遥测量地址表 AM5-M Telemetry address table			
地址	功能	长度	备注

Address	Function	Length	Notice
0x0000	Ia	32bit	保护电流 Ia
0x0001			Protection current Ia
0x0002	Ib	32bit	保护电流 Ib
0x0003			Protection current Ib
0x0004	Ic	32bit	保护电流 Ic
0x0005			Protection current Ic
0x0006	I1	32bit	正序电流 I1
0x0007			Positive sequence current I1
0x0008	I2	32bit	负序电流 I2
0x0009			Negative sequence current I2
0x000A	I01	32bit	零序电流 I01
0x000B			Zero sequence current I01
0x000C	I02	32bit	零序电流 I02
0x000D			Zero sequence current I02
0x000E	IA	32bit	测量电流 IA
0x000F			Measuring current IA
0x0010	IB	32bit	测量电流 IB
0x0011			Measuring current IB
0x0012	IC	32bit	测量电流 IC
0x0013			Measuring current IC
0x0014	UAB	32bit	线电压 UAB
0x0015			Line voltage UAB
0x0016	UBC	32bit	线电压 UBC
0x0017			Line voltage UBC
0x0018	UCA	32bit	线电压 UCA
0x0019			Line voltage UCA
0x001A	U0	32bit	零序电压 U0
0x001B			Zero sequence voltage U0
0x001C	Fr	32bit	频率
0x001D			Frequency
0x001E	P	32bit	有功功率
0x001F			Active power
0x0020	PF	32bit	功率因数
0x0021			Power factor
0x0022	U1	32bit	正序电压
0x0023			Positive sequence voltage
0x0024	U2	32bit	负序电压
0x0025			Negative sequence voltage
0x0026	Uav	32bit	电压平均值
0x0027			Voltage average
0x0028	Q	32bit	无功功率

0x0029			Reactive power
0x002A	S	32bit	视在功率
0x002B			Apparent power
0x002C	Ep	32bit	有功电能
0x002D			Active electric energy
0x002E	Eq	32bit	无功电能
0x002F			Reactive electric energy
0x0030	Es	32bit	视在电能
0x0031			Apparent electric energy
0x0032	Ia_H2	32bit	保护电流 Ia 二次谐波
0x0033			Ia Second harmonic
0x0034	Ib_H2	32bit	保护电流 Ib 二次谐波
0x0035			Ib Second harmonic
0x0036	Ic_H2	32bit	保护电流 Ic 二次谐波
0x0037			Ic Second harmonic
0x0038	QFcnt	32bit	断路器分合次数
0x0039			Action times of circuit breaker
0x003A	df	32bit	频率变化率
0x003B			Frequency change rate
0x003C	Ep+	32bit	正向有功电度
0x003D			
0x003E	Ep-	32bit	反向有功电度
0x003F			
0x0040	Eq+	32bit	正向无功电度
0x0041			
0x0042	Eq-	32bit	反向无功电度
0x0043			
0x0044	Eq_L	32bit	感性无功
0x0045			
0x0046	Eq_C	32bit	容性无功
0x0047			
0x0048	Eq I	32bit	I 象限无功
0x0049			
0x004A	Eq II	32bit	II 象限无功
0x004B			
0x004C	EqIII	32bit	III 象限无功
0x004D			
0x004E	EqIV	32bit	IV 象限无功
0x004F			
0x0050	I01_H2	32bit	零序电流二次谐波
0x0051			I01 Second harmonic

AM5-C 遥测量地址表 AM5-C Telemetry address table			
地址 Address	功能 Function	长度 Length	备注 Notice
0x0000	Ia	32bit	保护电流 Ia
0x0001			Protection current Ia
0x0002	Ib	32bit	保护电流 Ib
0x0003			Protection current Ib
0x0004	Ic	32bit	保护电流 Ic
0x0005			Protection current Ic
0x0006	Ibp	32bit	不平衡电流 Ibp
0x0007			Unbalance current Ibp
0x0008	I0	32bit	零序电流 I0
0x0009			Zero sequence current I0
0x000A	IA	32bit	测量电流 IA
0x000B			Measuring current IA
0x000C	IB	32bit	测量电流 IB
0x000D			Measuring current IB
0x000E	IC	32bit	测量电流 IC
0x000F			Measuring current IC
0x0010	UAB	32bit	线电压 UAB
0x0011			Line voltage UAB
0x0012	UBC	32bit	线电压 UBC
0x0013			Line voltage UBC
0x0014	UCA	32bit	线电压 UCA
0x0015			Line voltage UCA
0x0016	Uub	32bit	不平衡电压 Uub
0x0017			Unbalance voltage Uub
0x0018	Fr	32bit	频率
0x0019			Frequency
0x001A	P	32bit	有功功率
0x001B			Active power
0x001C	Q	32bit	无功功率
0x001D			Reactive power
0x001E	PF	32bit	功率因数
0x001F			Power factor
0x0020	3U0	32bit	自产零序电压
0x0021			Self-produced zero-sequence voltage
0x0022	U1	32bit	正序电压
0x0023			Positive sequence voltage
0x0024	U2	32bit	负序电压
0x0025			Negative sequence voltage

0x0026	S	32bit	视在功率
0x0027			Apparent power
0x0028	Ep	32bit	有功电能
0x0029			Active electric energy
0x002A	Eq	32bit	无功电能
0x002B			Reactive electric energy
0x002C	Es	32bit	视在电能
0x002D			Apparent electric energy
0x002E	Ia_H2	32bit	保护电流 Ia 二次谐波
0x002F			Ia Second harmonic
0x0030	Ib_H2	32bit	保护电流 Ib 二次谐波
0x0031			Ib Second harmonic
0x0032	Ic_H2	32bit	保护电流 Ic 二次谐波
0x0033			Ic Second harmonic
0x0034	QFcnt	32bit	断路器分合次数
0x0035			Action times of circuit breaker
0x0036	df	32bit	频率变化率
0x0037			Frequency change rate
0x0038	Ep+	32bit	正向有功电度
0x0039			
0x003A	Ep-	32bit	反向有功电度
0x003B			
0x003C	Eq+	32bit	正向无功电度
0x003D			
0x003E	Eq-	32bit	反向无功电度
0x003F			
0x0040	Eq_L	32bit	感性无功
0x0041			
0x0042	Eq_C	32bit	容性无功
0x0043			
0x0044	Eq I	32bit	I 象限无功
0x0045			
0x0046	Eq II	32bit	II 象限无功
0x0047			
0x0048	EqIII	32bit	III象限无功
0x0049			
0x004A	EqIV	32bit	IV象限无功
0x004B			

AM5-B 遥测量地址表 AM5-B Telemetry address table			
地址	功能	长度	备注

Address	Function	Length	Notice
0x0000	Ia	32bit	保护电流 Ia
0x0001			Protection current Ia
0x0002	Ib	32bit	保护电流 Ib
0x0003			Protection current Ib
0x0004	Ic	32bit	保护电流 Ic
0x0005			Protection current Ic
0x0006	I1	32bit	进线电流 I1
0x0007			Incoming current I1
0x0008	I2	32bit	进线电流 I2
0x0009			Incoming current I2
0x000A	I0	32bit	零序电流 I0
0x000B			Zero sequence current I0
0x000C	IA	32bit	测量电流 IA
0x000D			Measuring current IA
0x000E	U1	32bit	进线电压 U1
0x000F			Incoming voltage U1
0x0010	U2	32bit	进线电压 U2
0x0011			Incoming voltage U2
0x0012	Uab1	32bit	线电压 Uab1
0x0013			Line voltage Uab1
0x0014	Ubc1	32bit	线电压 Ubc1
0x0015			Line voltage Ubc1
0x0016	Uab2	32bit	线电压 Uab2
0x0017			Line voltage Uab2
0x0018	Ubc2	32bit	线电压 Ubc2
0x0019			Line voltage Ubc2
0x001A	Fr	32bit	频率
0x001B			Frequency
0x001C	Ia1	32bit	保护电流一次值 Ia1
0x001D			Primary protection current Ia1
0x001E	Ib1	32bit	保护电流一次值 Ib1
0x001F			Primary protection current Ib1
0x0020	Ic1	32bit	保护电流一次值 Ic1
0x0021			Primary protection current Ic1
0x0022	IA1	32bit	测量电流一次值 IA1
0x0023			Primary measuring current IA1
0x0024	IB1	32bit	测量电流一次值 IB1
0x0025			Primary measuring current IB1
0x0026	IC1	32bit	测量电流一次值 IC1
0x0027			Primary measuring current IC1

AM5-DB 遥测量地址表 AM5-DB Telemetry address table			
地址 Address	功能 Function	长度 Length	备注 Notice
0x0000	Ia	32bit	保护电流 Ia
0x0001			Protection current Ia
0x0002	Ib	32bit	保护电流 Ib
0x0003			Protection current Ib
0x0004	Ic	32bit	保护电流 Ic
0x0005			Protection current Ic
0x0006	I1	32bit	进线电流 I1
0x0007			Incoming current I1
0x0008	I2	32bit	进线电流 I2
0x0009			Incoming current I2
0x000A	IA	32bit	测量电流 IA
0x000B			Measuring current IA
0x000C	U1	32bit	进线电压 U1
0x000D			Incoming voltage U1
0x000E	U2	32bit	进线电压 U2
0x000F			Incoming voltage U2
0x0010	Uab1	32bit	线电压 Uab1
0x0011			Line voltage Uab1
0x0012	Ubc1	32bit	线电压 Ubc1
0x0013			Line voltage Ubc1
0x0014	Uab2	32bit	线电压 Uab2
0x0015			Line voltage Uab2
0x0016	Ubc2	32bit	线电压 Ubc2
0x0017			Line voltage Ubc2
0x0018	Fr	32bit	频率
0x0019			Frequency
0x001A	Ia1	32bit	保护电流一次值 Ia1
0x001B			Primary protection current Ia1
0x001C	Ib1	32bit	保护电流一次值 Ib1
0x001D			Primary protection current Ib1
0x001E	Ic1	32bit	保护电流一次值 Ic1
0x001F			Primary protection current Ic1
0x0020	IA1	32bit	测量电流一次值 IA1
0x0021			Primary measuring current IA1

AM5-U1 遥测量地址表 AM5-U1 Telemetry address table			
地址	功能	长度	备注

Address	Function	Length	Notice
0x0000	UAB	32bit	线电压 UAB
0x0001			Line voltage UAB
0x0002	UBC	32bit	线电压 UBC
0x0003			Line voltage UBC
0x0004	UCA	32bit	线电压 UCA
0x0005			Line voltage UCA
0x0006	U4	32bit	通道 4 电压
0x0007			4 passage voltage
0x0008	Fr	32bit	频率
0x0009			Frequency
0x000A	U1	32bit	正序电压
0x000B			Positive sequence voltage
0x000C	U2	32bit	负序电压
0x000D			Negative sequence voltage
0x000E	3U0	32bit	自产零序电压
0x000F			Self-produced zero-sequence voltage

附录 D 事件记录

Accessories D Event Record

AM 事件记录 AM Event Record				
事件代码 Event code	事件名称 Event name	参数名称 Parameter name	参数值 Parameter values	参数单位 Parameter unit
0	过流一段保护 3I>>>	A 相电流 Ia	浮点数 Float	A
		B 相电流 Ib	浮点数 Float	A
		C 相电流 Ic	浮点数 Float	A
		UAB	浮点数 Float	V
		UBC	浮点数 Float	V
		UCA	浮点数 Float	V
		负序电压 U2	浮点数 Float	V
		A 相二次谐波电流 Ia_H2	浮点数 Float	A
		B 相二次谐波电流 Ib_H2	浮点数 Float	A
		C 相二次谐波电流 Ic_H2	浮点数 Float	A
1	过流二段保护 3I>>	A 相电流 Ia	浮点数 Float	A
		B 相电流 Ib	浮点数 Float	A
		C 相电流 Ic	浮点数 Float	A
		UAB	浮点数 Float	V
		UBC	浮点数 Float	V
		UCA	浮点数 Float	V
		负序电压 U2	浮点数 Float	V
		A 相二次谐波电流	浮点数	A

		la_H2	Float	
		B 相二次谐波电流 lb_H2	浮点数 Float	A
		C 相二次谐波电流 lc_H2	浮点数 Float	A
2	过流三段保护 3I>	A 相电流 la	浮点数 Float	A
		B 相电流 lb	浮点数 Float	A
		C 相电流 lc	浮点数 Float	A
		UAB	浮点数 Float	V
		UBC	浮点数 Float	V
		UCA	浮点数 Float	V
		负序电压 U2	浮点数 Float	V
		A 相二次谐波电流 la_H2	浮点数 Float	A
		B 相二次谐波电流 lb_H2	浮点数 Float	A
		C 相二次谐波电流 lc_H2	浮点数 Float	A
3	启动时过流一段保护 3I>>>.S	A 相电流 la	浮点数 Float	A
		B 相电流 lb	浮点数 Float	A
		C 相电流 lc	浮点数 Float	A
4	运行时过流一段保护 3I>>>.R	A 相电流 la	浮点数 Float	A
		B 相电流 lb	浮点数 Float	A
		C 相电流 lc	浮点数 Float	A
5	A 相反时限过流保护 la>InverseT.	时间 t	浮点数	s
		A 相电流 la	浮点数 Float	A
		B 相电流 lb	浮点数 Float	A

		C 相电流 Ic	浮点数 Float	A
		UAB	浮点数 Float	V
		UBC	浮点数 Float	V
		UCA	浮点数 Float	V
		负序电压 U2	浮点数 Float	V
6	B 相反时限过流保护 Ib>InverseT.	时间 t	浮点数	s
		A 相电流 Ia	浮点数 Float	A
		B 相电流 Ib	浮点数 Float	A
		C 相电流 Ic	浮点数 Float	A
		UAB	浮点数 Float	V
		UBC	浮点数 Float	V
		UCA	浮点数 Float	V
		负序电压 U2	浮点数 Float	V
7	C 相反时限过流保护 Ic>InverseT.	时间 t	浮点数	s
		A 相电流 Ia	浮点数 Float	A
		B 相电流 Ib	浮点数 Float	A
		C 相电流 Ic	浮点数 Float	A
		UAB	浮点数 Float	V
		UBC	浮点数 Float	V
		UCA	浮点数 Float	V
		负序电压 U2	浮点数 Float	V
8	I01 过流一段	I01	浮点数	A

	I01>>>		Float	
9	I01 过流二段 I01>>	I01	浮点数 Float	A
10	I02 过流一段 I02>>>	I02	浮点数 Float	A
11	I02 过流二段 I02>>	I02	浮点数 Float	A
12	I01 反时限 I01>InverseT.	时间 t	浮点数 Float	s
		I01	浮点数 Float	A
13	I02 反时限 I02>InverseT.	时间 t	浮点数 Float	s
		I02	浮点数 Float	A
14	后加速过流保护 I>P.T	A 相电流 Ia	浮点数 Float	A
		B 相电流 Ib	浮点数 Float	A
		C 相电流 Ic	浮点数 Float	A
15	重合闸 Reclose	---	---	---
16	低频减载 UnderFr.	频率 Frequency	浮点数 Float	Hz
17	手动合闸 ManualClose	---	---	---
18	手动分闸 ManualTrip	---	---	---
19	过负荷跳闸 OverLoadTrip	最大相电流 Im	浮点数 Float	A
20	负序过流一段保护 I2>>>	负序电流 I2	浮点数 Float	A
		最大相电流 Im	浮点数 Float	A
21	负序反时限保护 I2>InverseT	时间 t	浮点数 Float	s
		负序电流 I2	浮点数 Float	A
22	热过载跳闸 OverHeat.T	跳闸百分比 Trip Percent	浮点数 Float	%
		最大相电流 Im	浮点数 Float	A

		正序电流 I1	浮点数 Float	A
		负序电流 I2	浮点数 Float	A
23	堵转保护 StallTrip	最大相电流 Im	浮点数 Float	A
24	启动时间过长保护 StartOutTime	最大相电流 Im	浮点数 Float	A
25	低电压保护 LVPT	最大线电压 Um	浮点数 Float	V
26	欠电压保护 LVPT	UAB	浮点数 Float	V
		UBC	浮点数 Float	V
		UCA	浮点数 Float	V
27	过电压保护 OVPT	UAB	浮点数 Float	V
		UBC	浮点数 Float	V
		UCA	浮点数 Float	V
28	零序过电压保护/自产零序过 压保护 U0.OVP/3U0.OVP	零序电压 U0	浮点数 Float	V
29	不平衡电压保护 Unb.V.T	不平衡 U Unb.V	浮点数 Float	V
30	不平衡电流保护 Unb.I.T	不平衡 I Unb.I	浮点数 Float	A
31	重瓦斯跳闸 SevereGas.T	---	---	---
32	压力释放跳闸 Pre.Re.T	---	---	---
33	超温跳闸 HighTemp.T	---	---	---
34	非电量 1 跳闸/计量门 1 跳闸 Non-el1.T/Me.do1.T	---	---	---
35	非电量 2 跳闸/计量门 2 跳闸 Non-el2.T/Me.do2.T	---	---	---
36	分段备投合母联 B.S.C.B.	---	---	---
37	分段备投跳进线 1 B.S.T.1	---	---	---

38	分段备投跳进线 2 B.S.T.2	---	---	---
39	2 备 1 跳进线 1 2S.1T.1-In.	---	---	---
40	2 备 1 合进线 2 2S.1C.2-In.	---	---	---
41	1 备 2 跳进线 2 1S.2T.2-In.	---	---	---
42	1 备 2 合进线 1 1S.2C.1-In.	---	---	---
43	分段复归合进线 1 B.R.C.1	---	---	---
44	分段复归合进线 2 B.R.C.2	---	---	---
45	分段复归跳母联 B.R.T.B.	---	---	---
46	2 备 1 复归合进线 1 2S.1R.C.1	---	---	---
47	2 备 1 复归跳进线 2 2S.1R.T.2	---	---	---
48	1 备 2 复归合进线 2 1S.2R.C.2	---	---	---
49	1 备 2 复归跳进线 1 1S.2R.T.1	---	---	---
50	FC 闭锁 FC Block	A 相电流 Ia	浮点数 Float	A
		B 相电流 Ib	浮点数 Float	A
		C 相电流 Ic	浮点数 Float	A
51	变压器门误开跳闸 DoorOpenT	---	---	---
52	遥控合闸 RemoteClose	---	---	---
53	遥控分闸 RemoteTrip	---	---	---
54	失压保护 LVPT	最大线电压 Um	浮点数 Float	V
55	油位低跳闸 Low oil.T	---	---	---
56	油位高跳闸 High oil.T	---	---	---
57	反时限过流保护	时间	浮点数	s

	I>InverseT.	t	Float	
		A 相电流 Ia	浮点数 Float	A
		B 相电流 Ib	浮点数 Float	A
		C 相电流 Ic	浮点数 Float	A
58	I01 过流三段 I01>	I01	浮点数 Float	A
59	I01 后加速过流 I01>P.T	时间 t	浮点数 Float	s
		I01	浮点数 Float	A
60	高温保护跳闸 OverTemp.T	---	---	---
61	轻瓦斯保护跳闸 LightGasT	---	---	---
62	2 备 1 跳母联 2S.1T.B.	---	---	---
63	2 备 1 复归合母联 2S.1R.C.B.	---	---	---
64	柴发机备投跳进线 1 Die.S.T.1	---	---	---
65	柴发机备投跳进线 2 Die.S.T.2	---	---	---
66	柴发机备投合母联 Die.S.C.B.	---	---	---
67	柴发机备投合柴发机 Die.S.C.D.	---	---	---
68	非电量 3 跳闸 Non-el3.T	---	---	---
69	非电量 4 跳闸 Non-el4.T	---	---	---
70	备用 1 跳闸 Spare1.T	---	---	---
71	备用 2 跳闸 Spare2.T	---	---	---
73	备用 3 跳闸 Spare3.T	---	---	---
74	隔离柜连跳 Iso.Cab.T	---	---	---
75	系统谐振跳闸	---	---	---

	Sys.Res.T			
76	高频保护 OF.T	频率 Frequency	浮点数 Float	Hz
77	温控器故障跳闸 Th.Fa.T	---	---	---
78	自产 3I0 保护一段跳闸 3I0>>>	A 相电流 Ia	浮点数 Float	A
		B 相电流 Ib	浮点数 Float	A
		C 相电流 Ic	浮点数 Float	A
		3I0	浮点数 Float	A
79	自产 3I0 保护二段跳闸 3I0>>	A 相电流 Ia	浮点数 Float	A
		B 相电流 Ib	浮点数 Float	A
		C 相电流 Ic	浮点数 Float	A
		3I0	浮点数 Float	A
80	过负荷告警 OverLoadAla.	最大相电流 Im	浮点数 Float	A
81	PT 断线告警 (AM5、AM4-U) PT BreakAla.	UAB	浮点数 Float	V
		UBC	浮点数 Float	V
		UCA	浮点数 Float	V
		负序电压 U2	浮点数 Float	V
82	控故障告警 CtrErrorAla.	---	---	---
83	负序过流二段告警 I2>>.A	负序电流 I2	浮点数 Float	A
		最大相电流 Im	浮点数 Float	A
84	热过载告警 OverHeat.A	告警百分比 Alarm percent	浮点数 Float	%
		最大相电流 Im	浮点数 Float	A
		正序电流 I1	浮点数 Float	A

		负序电流 I2	浮点数 Float	A
85	I 母低电压告警 (AM5\AM4-U1) I Bus LVP.A	最大线电压 Um	浮点数 Float	V
86	I 母过电压告警 (AM5\AM4-U1) I Bus OVP.A	最大线电压 Um	浮点数 Float	V
87	I 母零序过压告警 (AM5\AM4-U1) I Bus U0.OVP.A	零序电压 U0	浮点数 Float	V
88	轻瓦斯告警 LightGasA			
89	高温告警 OverTemp.A			
90	非电量 2 告警 Non-el2.A	---	---	---
91	非电量 3 告警 Non-el3.A	---	---	---
92	分段充电完成 BusCharge	---	---	---
93	进线 1 充电完成 I-In.Charge	---	---	---
94	进线 2 充电完成 2-In.Charge	---	---	---
95	I 母自产零序过压告警 (AM5\AM4-U1) I Bus 3U0.OVP.A	零序电压 U0	浮点数 Float	V
96	II 母低电压告警 (AM5\AM4-U2) II Bus LVP.A	最大线电压 Um	浮点数 Float	V
97	II 母零序过压告警 (AM5\AM4-U2) II Bus U0.OVP.A	零序电压 U0	浮点数 Float	V
98	II 母 PT 断线告警 (AM5\AM4-U2) II Bus PT BreakAla.	UAB2	浮点数 Float	V
		UBC2	浮点数 Float	V
		UCA2	浮点数 Float	V
		负序电压 U2	浮点数 Float	V
99	II 母过电压告警	最大线电压	浮点数	V

	(AM5\AM4-U2) II Bus OVP.A	Um	Float	
100	II 母自产零序过压告警 (AM5\AM4-U2) II Bus 3U0.OVP.A	自产 3U0 3U0	浮点数 Float	V
101	电机备投跳进线 1,2 M.S.T.1,2	---	---	---
102	电机备投合电机 M.S.C.M.	---	---	---
103	过流三段告警 3I>.A	A 相电流 Ia	浮点数 Float	A
		B 相电流 Ib	浮点数 Float	A
		C 相电流 Ic	浮点数 Float	A
104	I01 过流一段告警 I01>>>.A	时间 t	浮点数 Float	s
		I01	浮点数 Float	A
105	I01 过流二段告警 I01>>.A	时间 t	浮点数 Float	s
		I01	浮点数 Float	A
106	I01 过流三段告警 I01>.A	时间 t	浮点数 Float	s
		I01	浮点数 Float	A
107	I01 反时限过流告警 I01>InverseT.A	时间 t	浮点数 Float	s
		I01	浮点数 Float	A
108	I01 后加速告警 I01>P.A	时间 t	浮点数 Float	s
		I01	浮点数 Float	A
109	I02 过流告警 I02>.A	时间 t	浮点数 Float	s
		I02	浮点数 Float	A
110	I02 反时限过流告警 I02>InverseT.A	时间 t	浮点数 Float	s
		I02	浮点数 Float	A

111	负序过流一段告警 I2>>>.A	负序电流 I2	浮点数 Float	A
		最大相电流 Im	浮点数 Float	A
112	超温保护告警 HighTemp.A			
113	重瓦斯保护告警 SevereGas.A			
114	失压告警 LVP.A	最大线电压 Um	浮点数 Float	V
115	I02 过流一段告警 I02>>>.A	时间 t	浮点数 Float	s
		I02	浮点数 Float	A
116	I02 过流二段告警 I02>>.A	时间 t	浮点数 Float	s
		I02	浮点数 Float	A
117	门开告警 DoorOpenA	时间 t	浮点数 Float	s
118	进线 PT 断线 I.PtBr.A	---	---	---
119	非电量 1 告警 Non-el1.A			s
120	非电量 4 告警 Non-el4.A			s
121	重合闸充电完成 chargeOK	---	---	---
122	备用 1 告警 Spare1.A	---	---	---
123	备用 2 告警 Spare2.A	---	---	---
124	备用 3 告警 Spare3.A	---	---	---
125	市电充电 Mark.Charge	---	---	---
126	市电备投跳发电机 Mark.S.T.D.	---	---	---
127	市电备投合进线 1 Mark.S.C.1	---	---	---
128	市电备投合进线 2 Mark.S.C.2	---	---	---
129	逆功率保护	有功功率	浮点数	kW

	R.P.T	Active power	Float	
		功率因数 Power factor	浮点数 Float	
130	压力释放告警 Pre.Re.A	---	---	---
131	发电机备 1 充电 Al.S.1.Charge	---	---	---
132	发电机备 2 充电 Al.S.2.Charge	---	---	---
133	柴发机备 1 跳 1QF Die.S.1T.1QF	---	---	---
134	柴发机备 1 合 4QF Die.S.1C.4QF	---	---	---
135	柴发机备 2 跳 2QF Die.S.2T.2QF	---	---	---
136	柴发机备 2 合 4QF Die.S.2C.4QF	---	---	---
137	温控器故障告警 Th.Fa.A	---	---	---
138	二次过压告警（非电量） Se.OVP.A	---	---	---
139	不平衡电流 3I0 保护告警 Unb.3I0.A	A 相电流 Ia	浮点数 Float	A
		B 相电流 Ib	浮点数 Float	A
		C 相电流 Ic	浮点数 Float	A
		3I0	浮点数 Float	A
150	D11 变位 D11	---	---	---
151	D12 变位 D12	---	---	---
152	D13 变位 D13	---	---	---
153	D14 变位 D14	---	---	---
154	D15 变位 D15	---	---	---
155	D16 变位 D16	---	---	---
156	D17 变位 D17	---	---	---

	DI7			
157	DI8 变位 DI8	---	---	---
158	DI9 变位 DI9	---	---	---
159	DI10 变位 DI10	---	---	---
160	DI11 变位 DI11	---	---	---
161	DI12 变位 DI12	---	---	---
162	DI13 变位 DI13	---	---	---
163	DI14 变位 DI14	---	---	---
164	DI15 变位 DI15	---	---	---
165	DI16 变位 DI16	---	---	---
166	DI17 变位 DI17	---	---	---
167	DI18 变位 DI18	---	---	---
168	DI19 变位 DI19	---	---	---
169	DI20 变位 DI20	---	---	---
170	合后位置变位 Position after closing set	---	---	---
171	合位监视变位 CCB On set	---	---	---
172	分位监视变位 CCB Off set	---	---	---
173	防跳监视变位 Anti-pumping set	---	---	---
174	装置上电 Device on power	---	---	---
179	PT 断线 PT Break	---	---	---
180	3 备 1 充电 3S.1 Charge	---	---	---
181	3 备 2 充电	---	---	---

3S.2 Charge				
182	A 相差压跳闸 UdA.T	A 相差压 UdA	浮点数 Float	V
183	B 相差压跳闸 UdB.T	B 相差压 UdB	浮点数 Float	V
184	C 相差压跳闸 UdC.T	C 相差压 UdC	浮点数 Float	V
185	备投再恢复 1#合 3QF S.R.1#.C.3QF	---	---	---
186	均无压恢复充电 No-Vol.R.Charge	---	---	---
187	均无压复 2 跳 4 No-Vol.R.2.T.4	---	---	---
188	均无压复 2 合 2 No-Vol.R.2.C.2	---	---	---
189	均无压复 1 跳 4 No-Vol.R.1.T.4	---	---	---
190	均无压复 1 合 1 No-Vol.R.1.C.1	---	---	---
191	均无压复 1 合 3 No-Vol.R.1.C.3	---	---	---
192	远方按钮合闸 Remote button close	---	---	---
193	远方按钮分闸 Remote button trip	---	---	---
194	急停分闸 Emergency trip	---	---	---
195	2 备 1 合柴发 2S.1C.Die.	---	---	---
196	2 备 1 复归跳柴发 2S.1R.T.Die.	---	---	---
197	负控跳闸 Neg.Con.T	---	---	---
198	绝缘监测告警 Insul.Monit.A	---	---	---
199	绝缘监测跳闸 Insul.Monit.T	---	---	---
200	均无压充电 No-Vol.Charge	---	---	---
201	均无压跳 2 No-Vol.T.2	---	---	---
202	均无压合 1 No-Vol.C.1	---	---	---

203	备用进线备 1 充电 Sp.In.S1 Charge	---	---	---
204	备用进线备 2 充电 Sp.In.S2 Charge	---	---	---
205	备用进线备 1 跳进线 1 Sp.In.S1.T.1	---	---	---
206	备用进线备 1 合备用 Sp.In.S1.C.Sp.	---	---	---
207	备用进线备 2 跳进线 2 Sp.In.S2.T.2	---	---	---
208	备用进线备 2 合备用 Sp.In.S2.C.Sp	---	---	---
209	均无压跳进线 1,2 No-Vol.T.1,2	---	---	---
210	均无压合母联 No-Vol.C.B.	---	---	---
211	均无压合备用进线 No-Vol.C.Sp.In.	---	---	---
212	欠流告警 LIP.A	A 相电流 Ia	浮点数 Float	A
		B 相电流 Ib	浮点数 Float	A
		C 相电流 Ic	浮点数 Float	A
213	电压不平衡开入跳闸 Unb.V.DI.T	---	---	---
214	分段备投合进线 3 B.S.C.3	---	---	---
215	分段备投合进线 4 B.S.C.4	---	---	---
216	进线 1 逆功率 1-In.RP.T	---	---	---
217	2 备 1 退进线 1 手车 2S.1T.1-In.Hand.	---	---	---
218	2 备 1 复归合进线 1 手车 2S.1R.C.1-In.Hand.	---	---	---
219	低侧网门告警 Low S.D.A	---	---	---
220	低侧网门跳闸 Low S.D.T	---	---	---
221	事故总信号 Accident Signal	---	---	---
222	电压不平衡跳闸	---	---	---

	Unb.V.T			
223	相序保护跳闸 Ph.Se.T	---	---	---
224	断相保护跳闸 Break ph.T	---	---	---
225	I 段 PT 投入 I PT Invest.	---	---	---
226	II 段 PT 投入 II PT Invest.	---	---	---
227	PT 并列 PT Juxtaposition	---	---	---
228	1 号 2 号主供断电警报 1,2 Main supply outage.A	---	---	---
229	遥控并列 Remote Juxtaposition	---	---	---
230	遥控解列 Remote Splitting	---	---	---
231	母线充电保护 B.Cha.T	A 相电流 Ia	浮点数 Float	A
		B 相电流 Ib	浮点数 Float	A
		C 相电流 Ic	浮点数 Float	A
232	CT 二次过压跳闸 CT Se.OVP.T	---	---	---
233	CT 二次过压告警 CT Se.OVP.A	---	---	---
234	隔离手车连跳动作 Iso.Handcart.T	---	---	---
235	备投允许 Standby allowed	---	---	---
236	允许合闸信号 Allowable C.signal	---	---	---
237	柴发机备投跳母联 Die.S.T.B.			
238	备投启动柴发信号 S.Sta.Die.Sig.			
239	油位高告警 High oil.A			
240	均无压跳母联 No-Vol.T.B.			
241	负序过流二段跳闸 I2>>	负序电流 I2	浮点数 Float	A

		最大相电流 Im	浮点数 Float	A
242	差动总启动标志 Differential total start flag	---	---	---
243	差动速断保护 Differential quick break protection	动作时间 Action time	浮点数 Float	s
		A 相差流 IdA	浮点数 Float	A
		B 相差流 IdB	浮点数 Float	A
		C 相差流 IdC	浮点数 Float	A
		A 相制动 IrA	浮点数 Float	A
		B 相制动 IrB	浮点数 Float	A
		C 相制动 IrC	浮点数 Float	A
244	比率差动保护 Ratio differential protection	动作时间 Action time	浮点数 Float	s
		A 相差流 IdA	浮点数 Float	A
		B 相差流 IdB	浮点数 Float	A
		C 相差流 IdC	浮点数 Float	A
		A 相制动 IrA	浮点数 Float	A
		B 相制动 IrB	浮点数 Float	A
		C 相制动 IrC	浮点数 Float	A
245	差流越限 Differential current overshoot	A 相差流 IdA	浮点数 Float	A
		B 相差流 IdB	浮点数 Float	A
		C 相差流 IdC	浮点数 Float	A
246	正序过流一段保护 I1>>>	定值 Fixed value	浮点数 Float	A
		延时 Delayed	浮点数 Float	s
		正序电流	浮点数	A

		I1	Float	
247	正序过流二段保护 I1>>	定值 Fixed value	浮点数 Float	A
		延时 Delayed	浮点数 Float	s
		正序电流 I1	浮点数 Float	A
248	正序过流反时限保护 I1>InverseT.	曲线类型 Curve type	整数 Integer	一般/非常 /极端 S1/S2/S3
		启动电流 Starting current	浮点数 Float	A
		时间系数 Time coefficient	浮点数 Float	s
		动作时间 Action time	浮点数 Float	s
		正序电流 I1	浮点数 Float	A
249	长启动保护告警 Long start protection alarm	计时门槛 Timing threshold	浮点数 Float	A
		动作时间 Action time	浮点数 Float	s
250	电流不平衡告警 Unb.I.A	定值 Fixed value	浮点数 Float	A
		延时 Delayed	浮点数 Float	s
		动作值 Action value	浮点数 Float	A
		平均电流 Iavg	浮点数 Float	A
251	电压不平衡告警 Unb.V.A	定值 Fixed value	浮点数 Float	V
		延时 Delayed	浮点数 Float	s
		动作值 Action value	浮点数 Float	V
		平均线电压 Uavg	浮点数 Float	V
		UAB	浮点数 Float	V
		UBC	浮点数 Float	V
		UCA	浮点数 Float	V

			Float	
252	过电压保护告警 OVP.A	定值 Fixed value	浮点数 Float	V
		延时 Delayed	浮点数 Float	s
		UAB	浮点数 Float	V
		UBC	浮点数 Float	V
		UCA	浮点数 Float	V
		零序电压 U0	浮点数 Float	V
253	零序过压保护告警 U0.OVP.A	定值 Fixed value	浮点数 Float	V
		延时 Delayed	浮点数 Float	s
		UAB	浮点数 Float	V
		UBC	浮点数 Float	V
		UCA	浮点数 Float	V
		零序电压 U0	浮点数 Float	V
254	正序过压保护告警 U1.OVP.A	定值 Fixed value	浮点数 Float	V
		延时 Delayed	浮点数 Float	s
		UAB	浮点数 Float	V
		UBC	浮点数 Float	V
		UCA	浮点数 Float	V
		正序电压 U1	浮点数 Float	V
255	正序过压保护跳闸 U1.OVP.T	定值 Fixed value	浮点数 Float	V
		延时 Delayed	浮点数 Float	s
		UAB	浮点数 Float	V

		UBC	浮点数 Float	V
		UCA	浮点数 Float	V
		正序电压 U1	浮点数 Float	V
256	负序过压保护告警 U2.OVP.A	定值 Fixed value	浮点数 Float	V
		延时 Delayed	浮点数 Float	s
		UAB	浮点数 Float	V
		UBC	浮点数 Float	V
		UCA	浮点数 Float	V
		负序电压 U2	浮点数 Float	V
257	负序过压保护跳闸 U2.OVP.T	定值 Fixed value	浮点数 Float	V
		延时 Delayed	浮点数 Float	s
		UAB	浮点数 Float	V
		UBC	浮点数 Float	V
		UCA	浮点数 Float	V
		负序电压 U2	浮点数 Float	V
258	低电压保护告警 LVP.A	定值 Fixed value	浮点数 Float	V
		延时 Delayed	浮点数 Float	s
		UAB	浮点数 Float	V
		UBC	浮点数 Float	V
		UCA	浮点数 Float	V
		零序电压 U0	浮点数 Float	V
259	相序保护告警	延时	浮点数	s

	Ph.Se.A	Delayed	Float	
		UAB	浮点数 Float	V
		UBC	浮点数 Float	V
		UCA	浮点数 Float	V
		零序电压 U0	浮点数 Float	V
		正序电压 U1	浮点数 Float	V
		负序电压 U2	浮点数 Float	V
		平均线电压 Uavg	浮点数 Float	V
260	首端 CT 断线告警 F.CT Break.A	---	---	---
261	尾端 CT 断线告警 T.CT Break.A	---	---	---
262	I02 后加速过流 I02>P.T	时间 t	浮点数 Float	s
		I02	浮点数 Float	A
263	I02 后加速告警 I02>P.A	时间 t	浮点数 Float	s
		I02	浮点数 Float	A
264	差动保护长期启动 Long term start of differential protection	A 相差流 IdA	浮点数 Float	A
		B 相差流 IdB	浮点数 Float	A
		C 相差流 IdC	浮点数 Float	A
265				
266				
267	I 侧 CT 断线告警 I CT Break.A	---	---	---
268	II 侧 CT 断线告警 II CT Break.A	---	---	---

269	III侧 CT 断线告警 III CT Break.A	---	---	---
270	IV侧 CT 断线告警 IV CT Break.A	---	---	---
271	有压有流出口动作 Pressure and current outlet action	---	---	---
272	预留 (告警事件代码)			
289	Reserve			
290	启动风冷 Starting air cooling	A 相电流 Ia	浮点数 Float	A
		B 相电流 Ib	浮点数 Float	A
		C 相电流 Ic	浮点数 Float	A
291	闭锁调压 Blocking voltage regulation	A 相电流 Ia	浮点数 Float	A
		B 相电流 Ib	浮点数 Float	A
		C 相电流 Ic	浮点数 Float	A
292	间隙零序过流一段跳闸 Clearance I0>>>	间隙零序电流 Clearance I0	浮点数 Float	A
293	间隙零序过流二段跳闸 Clearance I0>>	间隙零序电流 Clearance I0	浮点数 Float	A
294	I 段 PT 投入 I PT Invest.	---	---	---
295	II 段 PT 投入 II PT Invest.	---	---	---
296	PT 自动并列 PT Juxtaposition	---	---	---
297	遥控并列 Remote Juxtaposition	---	---	---
298	遥控解列 Remote Splitting	---	---	---
299	负控保护跳闸 Neg.Con.T	时间 t	浮点数 Float	s
300	负控保护告警 Neg.Con.A	时间 t	浮点数 Float	s
301	PT 自动解列 PT Splitting	---	---	---
302	二次谐波闭锁	A 相二次谐波电流	浮点数	A

	SHB.	la_H2	Float	
		B 相二次谐波电流 lb_H2	浮点数 Float	A
		C 相二次谐波电流 lc_H2	浮点数 Float	A
303	1 备 2 跳非重要负荷 1S.2T.Unimp.Lo.	---	---	---
304	2 备 1 跳非重要负荷 2S.1T.Unimp.Lo.	---	---	---
305	I02 过流三段 I02>	I02	浮点数 Float	A
306	I02 过流三段告警 I02>.A	I02	浮点数 Float	A
307	检修状态闭锁 Maint.Sta.B.	---	---	---
308	电机温度 1 跳闸 M.Tem1.T	---	---	---
309	电机温度 1 告警 M.Tem1.A	---	---	---
310	电机温度 2 跳闸 M.Tem2.T	---	---	---
311	电机温度 2 告警 M.Tem2.A	---	---	---
312	电源监视跳闸 Pow.Monit.T	---	---	---
313	电源监视告警 Pow.Monit.A	---	---	---
314	备投停止柴发信号 S.St.Die.Sig.			
315	启动柜故障跳闸 St.Cab.Fa.T	---	---	---
316	启动柜故障告警 St.Cab.Fa.A	---	---	---
317	同期合闸 Synchronous.C	---	---	---
318	进线侧恢复充电 In.R.Charge	---	---	---
319	柴发充电 Die.Charge	---	---	---
320	市电恢复充电 Mark.R.Charge	---	---	---
321	柴发恢复充电 Die.R.Charge	---	---	---

322	柴发备投合柴发 Die.S.C.D.	---	---	---
323	市电恢复跳柴发 Mark.R.T.D.	---	---	---
324	市电恢复合市电 Mark.R.C.Mark.	---	---	---
325	柴发恢复合柴发 Mark.R.C.D.	---	---	---
326	弧光保护跳闸 Arc.Pro.T	---	---	---
327	弧光保护告警 Arc.Pro.A	---	---	---
328	均无压进线 1 充电 No-Vol.1-In.Charge	---	---	---
329	均无压进线 2 充电 No-Vol.2-In.Charge	---	---	---
330	均无压合 2 No-Vol.C.2	---	---	---
331	均无压跳 1 No-Vol.T.1	---	---	---
332	均无压跳 3 No-Vol.T.3	---	---	---
333	A 相二次谐波 A.SH.	A 相二次谐波电流 Ia_H2	浮点数 Float	A
		B 相二次谐波电流 Ib_H2	浮点数 Float	A
		C 相二次谐波电流 Ic_H2	浮点数 Float	A
334	B 相二次谐波 B.SH.	A 相二次谐波电流 Ia_H2	浮点数 Float	A
		B 相二次谐波电流 Ib_H2	浮点数 Float	A
		C 相二次谐波电流 Ic_H2	浮点数 Float	A
335	C 相二次谐波 C.SH.	A 相二次谐波电流 Ia_H2	浮点数 Float	A
		B 相二次谐波电流 Ib_H2	浮点数 Float	A
		C 相二次谐波电流 Ic_H2	浮点数 Float	A

总部：安科瑞电气股份有限公司

Headquarter: Acrel Co., LTD.

地址：上海市嘉定区育绿路 253 号

Address: No.253 Yulv Road Jiading District, Shanghai, China

电话：0086-21-69158338 0086-21-69156052 0086-21-59156392 0086-21-69156971

TEL.: 0086-21-69158338 0086-21-69156052 0086-21-59156392 0086-21-69156971

传真：0086-21-69158303

Fax: 0086-21-69158303

网址：www.acrel-electric.com

Web-site: www.acrel-electric.com

邮箱：ACREL008@vip.163.com

Email: ACREL008@vip.163.com

邮编：201801

Postcode: 201801

生产基地：江苏安科瑞电器制造有限公司

Manufacturer: Jiangsu Acrel Electrical Manufacturing Co., LTD.

地址：江苏省江阴市南闸街道东盟工业园区东盟路 5 号

Address: No.5 Dongmeng Road, Dongmeng industrial Park, Nanzha Street, Jiangyin

City, Jiangsu Province, China

电话(传真)：0086-510-86179970

TEL./Fax: 0086-510-86179970

网址：www.jsacrel.com

Web-site: www.jsacrel.com

邮箱：JY-ACREL001@vip.163.com

Email: JY-ACREL001@vip.163.com

邮编：214405

Postcode: 214405