

167

External Roche Coil and Switched Transformer Harmonic Meter

Installation and operation instruction V1.5

ACREL CO., Ltd.

DECLARATION

Please read the instructions carefully before using this product. The picture, labels and symbols involved are all owned by Acrel Co., Ltd. Any person who is not an employee of the company shall not publicly reprint all or part of the contents without written authorization.

The contents of this note will be constantly updated and revised, but it is inevitable that there is a slight discrepancy or error. Users should refer to the products purchased and can download and obtain the new version of the manual through www.ACREL.cn or sales channels.

CONTENT

Note:the instrument must be installed on site with the supporting open and closed transformer or roche coil.....	- 2 -
1. General.....	- 2 -
2. Size of product.....	- 2 -
3. Product function.....	- 2 -
4. Technical parameter.....	- 3 -
5. Installation.....	- 5 -
5.1 Shape and installing size (unit: mm)	- 5 -
5.2 Size of open type transformer (unit: mm)	- 5 -
5.3 installation.....	- 5 -
5.4Method of connection.....	- 6 -
6. Programming and use.....	- 7 -
6.1 Key function description.....	- 7 -
6.2 Instrument interface display.....	- 7 -
6.2.1Power parameter interface.....	- 8 -
Note: three-phase three-wire interface without phase voltage and phase separation power.....	- 8 -
6.2.2 Harmonic parameter interface.....	- 8 -
6.2.3 Electric energy display interface.....	- 10 -
6.2.4 Switch status display interface.....	- 10 -
6.2.5 Incident record.....	- 10 -
6.2.6Parameter setting.....	- 11 -
7. Communication wiring.....	- 15 -
7.1Transmission mode.....	- 16 -
7.2Information frame format.....	- 16 -
7.3Brief introduction of function code.....	- 17 -
7.3.1Function code 03H: read registe.....	- 17 -
7.4Communication application details.....	- 19 -
7.4.1Communication description.....	- 19 -
7.5 Communication reading value Vs actual value(Take Val_t as Communication reading value,Val_sas actual value)-	35 -
7.5.1Voltage,current,power factor ,frequency.....	- 35 -
7.5.2Active power,resctive,apparent power and electric energy.....	- 36 -
7.5.3Voltage wave peak coefficient,telephoe wave form factor,current K coefficient,voltage wave peak value,current/voltage positive sequence negative sequence,zero sequence component and unbalancedness.....	- 36 -
7.5.4Voltage/current harmonic data.....	- 37 -
7.5.5Time.....	- 37 -

Example: Read the number of years, MODSCAN in HEX reading mode can be read directly in the address bar 0X0081.....	- 37 -
7.5.6Event record.....	- 37 -
8 DL/T-645Communication Guideline.....	- 38 -
8.1 DL/T645-1997 protocol overview.....	- 38 -
8.2Transmission mode.....	- 38 -
8.3Protocol.....	- 39 -

Note:the instrument must be installed on site with the supporting open and closed transformer or roche coil.

1. General

The guide-rail harmonic meter with external roche coil and open type mutual inductor is suitable for energy saving renovation projects in high energy consumption industries such as smelting, steel, electric welding, semiconductor, etc. And also for power monitoring of distributed photovoltaic grid-connected cabinet, power demand side management and other applications. The utility model has the advantages of no need to remove primary bus, simple and convenient wiring, safe construction, saving transformation cost and improving efficiency for users. It integrates the measurement of all power parameters (such as current, voltage, active power, reactive power, apparent power, frequency, power factor, etc.), multi-rate electric energy measurement, four-quadrant electric energy measurement, harmonic analysis and electric energy monitoring and assessment management. At the same time, it has a variety of peripheral interface for user to choose: with RS485 communication interface, modbus-rtu protocol can meet the needs of communication network management; The function of "remote signal" and "remote control" of circuit breaker switch can be realized with switch quantity input and relay output. LCD display interface is adopted to realize parameter setting and control through panel keys, which is very suitable for real-time power monitoring system.

2. Size of product

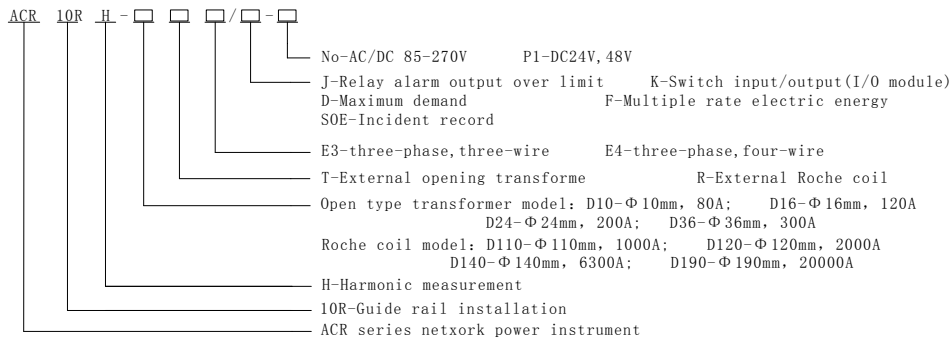

3. Product function

model		ACR10RH-DxxT (R) E4
Functional characteristic		ACR10RH-DxxT (R) E3
Display mode	LCD (Field LCD)	■
Measuring parameter	Current/voltage/frequency/power factor	■

	Active power/reactive power/apparent power	■
	Four quadrant electric energy measurement	■
	Maximum demand	□
	Multiple rate electric energy measurement	□
Power quality monitoring	Total harmonic content	■
	subharmonic (2-31 times)	■
Data logging	Incident record	□
	Alarm	□
	Built-in clock	□
communication	RS485 interface	■
Optional function(choose one)	J (2D0)	A1+ (B1 or C1) (4DI+2D0 or 4DI+EP)*
	K (4DI)	
	pulse (2channels)	

Note: 1、“■” is standard allocation function, “□” is matching function, Above instrument standard 1 channel RS485 communication;

- 2、Terminal connection mode corresponding to A1/B1/C1 and so on in selection function;
- 3、Pulse output and relay output can not be selected at the same time;
- 4、When you select an event logging feature, you must configure the DI or DO feature.

4. Technical parameter

Technical parameter		Value
Input	Net work	3-phase 3-wire,3-phase 4 wire
	Frequency	45~65Hz
	Voltage	Rating: AC 57.7V/100V(100V)、220V/380V(400V)
		Overload:1.2-fold rating(continuous);2-fold rating/1second
		Consumption:<0.2VA
	Current	Rating: 80A, 120A, 200A .etc (See specific product specifications, special parameters can be customized)
		Overload:1.2-fold rating(continuous);10-fold rating/1 second
		Consumption:< 0.2VA

Output	Electric energy		Output mode:Open-collector photocoupler pulse,two way output	
			Three-phase	Pulse constant: 4000、8000imp/kWh
	Communication		RS485 interface,Modbus-RTU Protocol	
	Display mode		LCD	
Function	Switching	input	Four way dry contact input	
		output	Output mode: two way relay nO contact output	
			Contact capacity: AC 250V/3A、DC 30V/3A	
Measuring accuracy		Frequency0.05Hz、 reactive electric energy1class、 other 0.5class		
Power supply		AC85~265V or DC100~350V; DC24V (±10%) ; DC48V (±10%) Consumption ≤10VA		
Safety	Power-frequency withstand voltage		Power frequency withstand voltage between Auxiliary power and switch volume output and current input and voltage input and communication and pulse output and switch volume input terminal is AC2kV 1min; Power frequency withstand voltage between auxiliary power and switch volume output and current input voltage input terminal is AC 2kV/1min; Power frequency withstand voltage between communication and pulse output and switch volume input terminal is AC 1kV/1min;	
	Insulation resistance		Input,Output terminal to housing>100MΩ	
Environment		Working temperature: -10℃~+55℃; Storage temperature: -20℃~+70℃ Relative humidity: 5%~95% No condensation; Altitude: ≤2500m		

5. Installation

5.1 Shape and installing size (unit: mm)

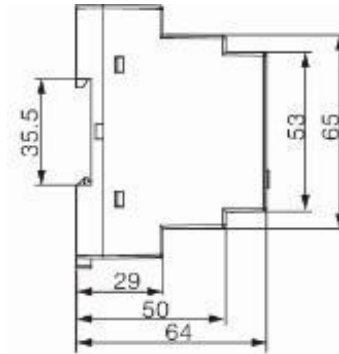
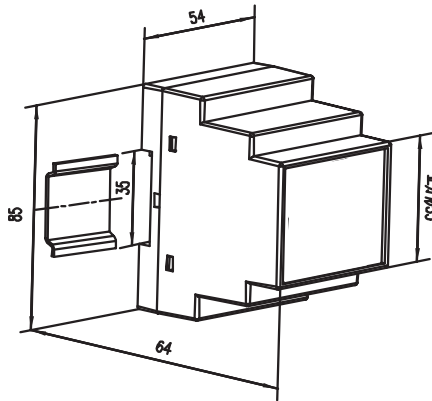

5.2 Size of open type transformer (unit: mm)

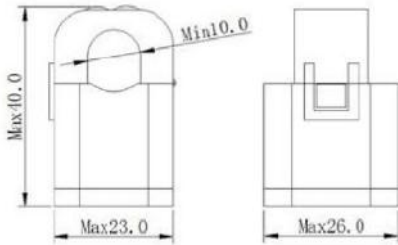

Φ 10mm

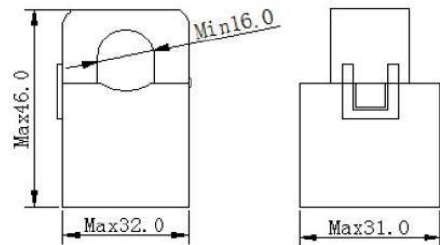

Φ 16mm

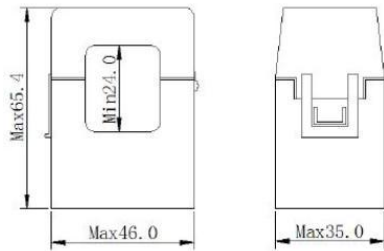

Φ 24mm

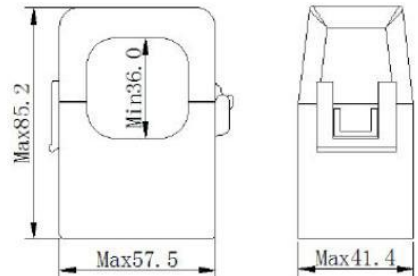

Φ 36mm

5.3 installation

Instrument installation method: DIN 35mm standard guide rail installation

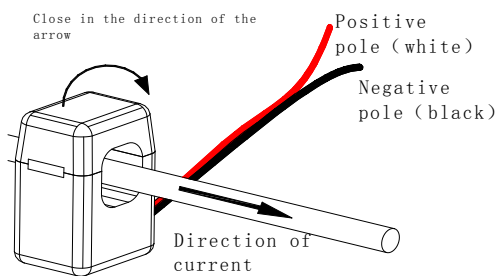

Installation method of open and close type mutual induction

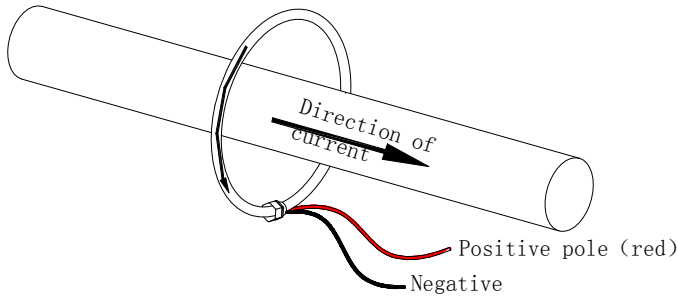

Roche coil mounting method

5.4 Method of connection

(Note: in case of any inconsistency with the wiring diagram on the meter housing, the wiring diagram on the meter housing shall prevail)

According to different design requirements, it is recommended to add fuses in the power supply and voltage input terminals to meet the safety requirements of relevant electrical codes

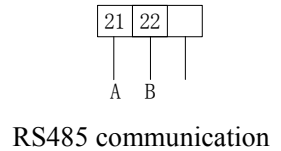
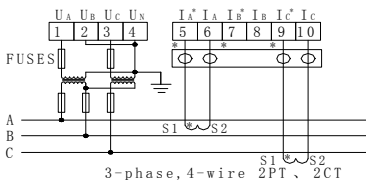
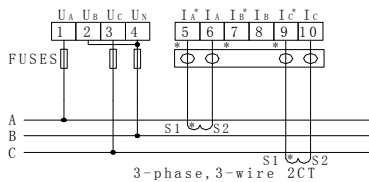
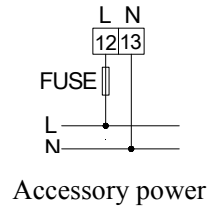
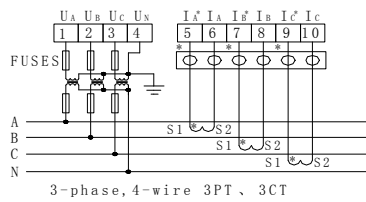
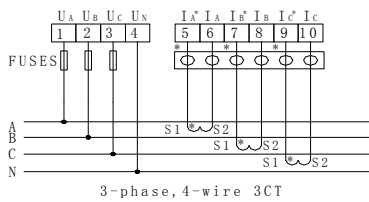

	A1										
A	<table border="1" style="width: 100%;"> <tr> <td style="text-align: center;">24</td> <td style="text-align: center;">25</td> <td style="text-align: center;">26</td> <td style="text-align: center;">27</td> <td style="text-align: center;">28</td> </tr> <tr> <td style="text-align: center;">Di</td> <td style="text-align: center;">Di</td> <td style="text-align: center;">Di</td> <td style="text-align: center;">Di</td> <td style="text-align: center;">Di</td> </tr> </table> <p style="text-align: center;">Switch input (4DI)</p>	24	25	26	27	28	Di	Di	Di	Di	Di
24	25	26	27	28							
Di	Di	Di	Di	Di							
	B1										
B	<table border="1" style="width: 100%;"> <tr> <td style="text-align: center;">34</td> <td style="text-align: center;">35</td> <td style="text-align: center;">36</td> </tr> <tr> <td style="text-align: center;">DO</td> <td style="text-align: center;">DO</td> <td style="text-align: center;">DO</td> </tr> </table> <p style="text-align: center;">Switch output (2DO)</p>	34	35	36	DO	DO	DO				
34	35	36									
DO	DO	DO									
	C1										
C	<table border="1" style="width: 100%;"> <tr> <td style="text-align: center;">17</td> <td style="text-align: center;">18</td> <td style="text-align: center;">19</td> </tr> <tr> <td style="text-align: center;">Epl</td> <td style="text-align: center;">+Eq</td> <td style="text-align: center;">E-</td> </tr> </table> <p style="text-align: center;">2 pulse (2EP)</p>	17	18	19	Epl	+Eq	E-				
17	18	19									
Epl	+Eq	E-									

注: ○ ○ ○ ○ ○ ○ It is a test terminal for CT secondary side short connection.

When three-phase three-wire connection is made, no. 2 terminal and no. 4 terminal shall be externally connected together

The fuse in the wiring diagram is recommended 0.5A or 3A.

When the instrument is installed on site, it must correspond to the supporting open and closed transformer or roche coil one by one, otherwise the measurement accuracy will be affected, and the connection between the two must be reliable.

6. Programming and use

6.1 Key function description

The five keys of the instrument from left to right are:FN、SET、▲、▶、ENTER。

FN	The button function is not open yet
Set	Under measuring mode, press this key to enter the setting interface; Under programming mode,this button is used for return to previous menu;
▲	Under measuring mode,press this button can page up the display items, see the display menu for related parameters; Under programming mode, used to toggle peer menus or single digit reductions。
▶	Under measuring mode,press this button can page down the display items, see the display menu for related parameters; Under programming mode,used to toggle peer menus or single digit increments。
Enter	Under programming mode,this button is used for confirming selection of menu item and revision of parameter

6.2 Instrument interface display

When the meter is powered on,the software version number will be displayed on the instant display interface,and the phase voltage interface will be displayed on the screen immediately afterwards.At this time,press the SET key to enter the main menu interface.After entering the main menu,you can press the up key or down key to select the project you want to view.When the project you want to view is in the state of anti-white,press the enter key to enter the project.

6.2.1 Power parameter interface

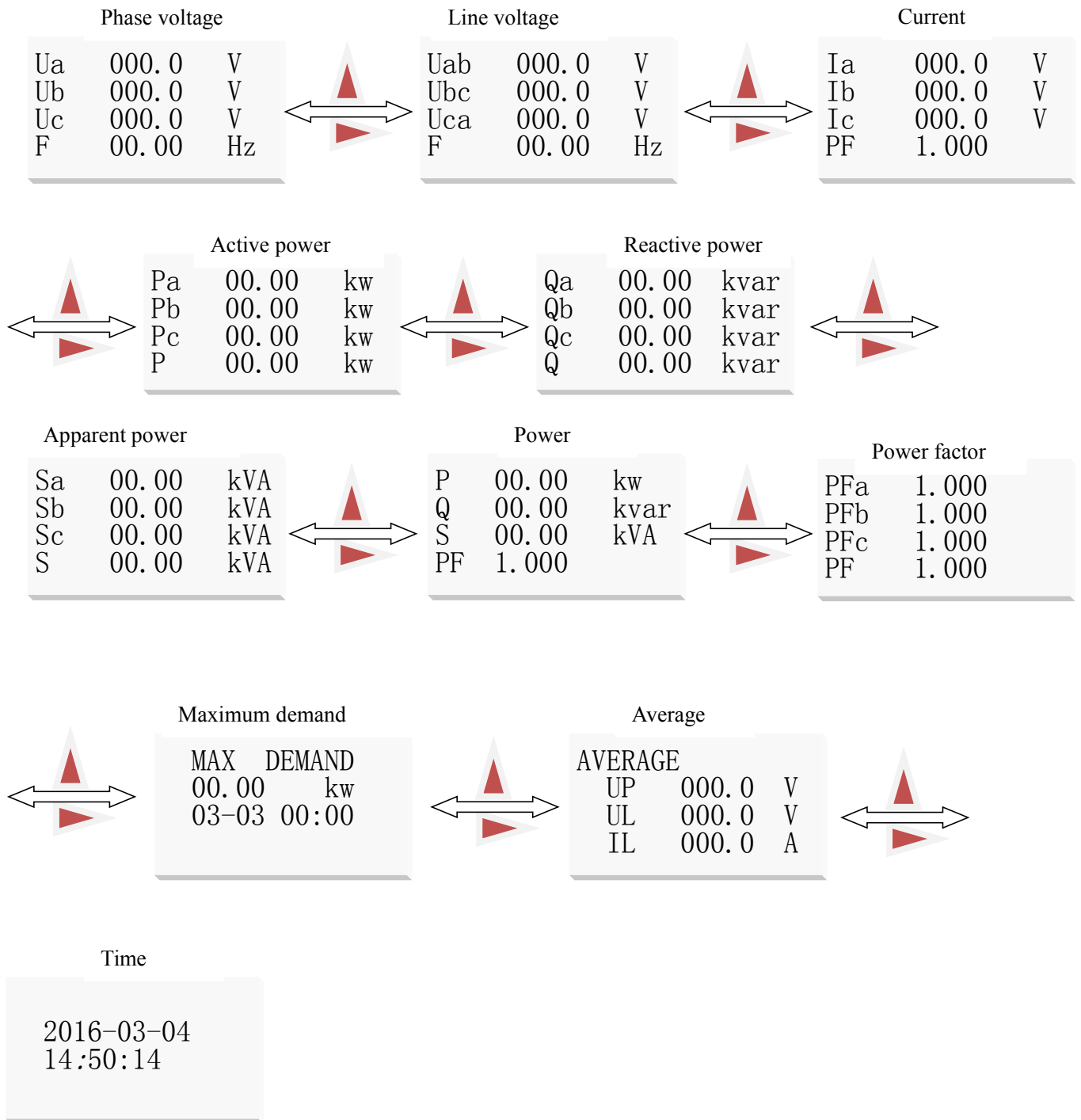

Note: three-phase three-wire interface without phase voltage and phase separation power

6.2.2 Harmonic parameter interface

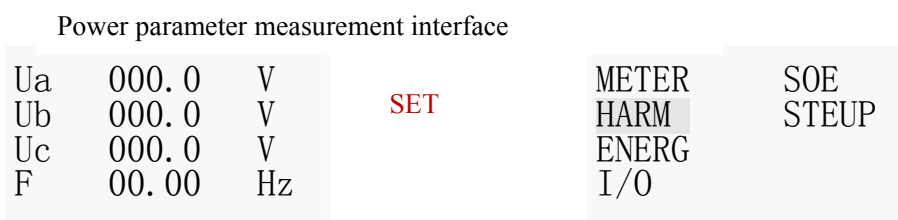

Harmonic measurement interface

VALUE
BAR

Total harmonic content

%	Ua	Ub	Uc
TH	00.00	00.00	00.00
%	Ia	Ib	Ic
TH	00.00	00.00	00.00

Subharmonic content

%	Ua	Ub	Uc
02	00.00	00.00	00.00
03	00.00	00.00	00.00
04	00.00	00.00	00.00
05	00.00	00.00	00.00

After selecting the harmonic parameters, the meter enters the interface of harmonic parameters by pressing the enter key. At this time, the harmonic data is in the state of anti-white. Press the enter key to view the voltage and current harmonic data.

When the harmonic data is in the state of anti-white, press the enter key to enter the interface of harmonic data, and the interface will display 2-7 times of voltage and harmonic, press up or down key to display other times of voltage and currwnt harmonic data and total harmonic THD, up to the maximum.

Note:harmonic data (graded harmonic amplitude/fundamental amplitude)*100% is the percentage content.

VALUE
BAR

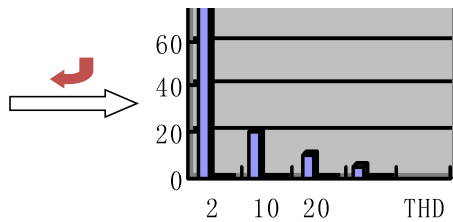

Histogram shows harmonic content

When the harmonic data is in the anti-white state, press the up key or the lower key to select the harmonic bar diagram, and then press the enter key to enter the harmonic bar diagram interface, change the harmonic bar diagram of phase A voltage and current to display the harmonic bar diagram of phase A voltage and current, press the up key or the down key to switch to display B.C two-phase harmonic bar diagram.

Note: the bar diagram shows up to 21 times.

6.2.3 Electric energy display interface

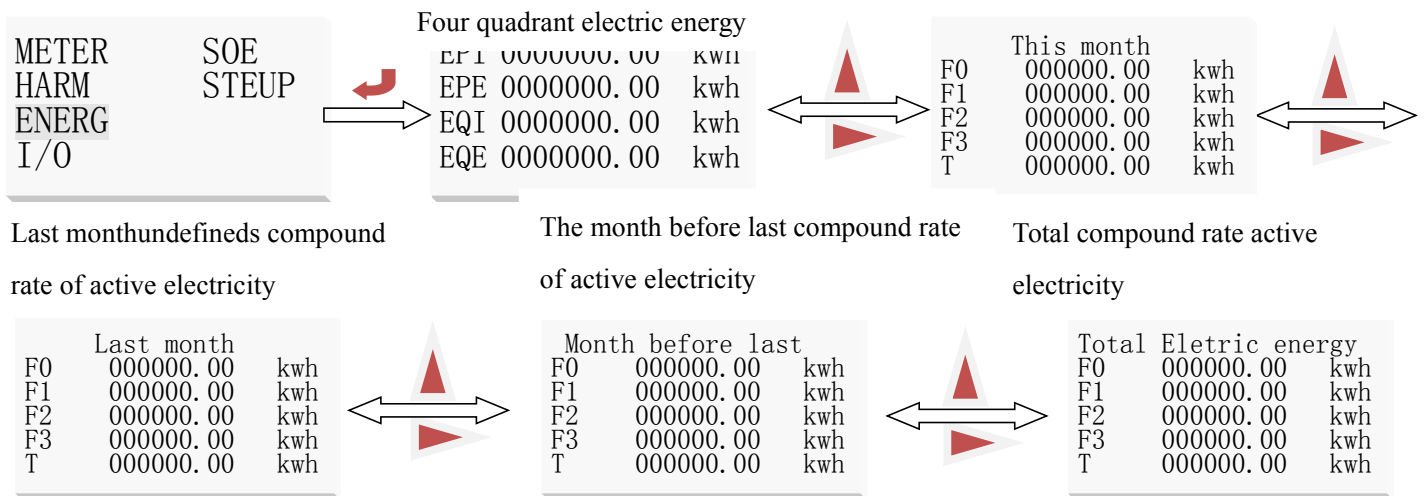

1、 Four-quadrant electric energy refers to forward active power,reverse active power,inductive reactive power and capacitive reactive power respectively.Generally speaking,users read forward active power EPI;The energy measurement of the double rate is divided into two time zones,one time zone is 8 times,and the second time zone is 9 times(one time zone can be set by buttons and communication).The second time zone can only be set in the middle;if the factory has been set to a double time zone,the adjustment menu setting rate can only modify the contents of a time zone,to be modified to a single time area,communication settings),four rates (F0-active pointed peak power,F1-active peak power,F2-active flat electric energy,F3-active valley electric energy)to complete the time-sharing measurement of electric energy.

2、 T represents the total compound rate of active electricity for the month.

3、 When jumping from 23:59:59 to 00:00:00 on the 1st of the following month,the EPI value of monthly active power will automatically be put into the dis interface of “active Power EPI(F0-T) last month”.Last month,the active power EPI(F0-T) value was put into the display interface of “active power EPI(F0-T) the month before last”,and the display value of “active power EIMP (F0-F4)of this month”was zero

6.2.4 Switch status display interface

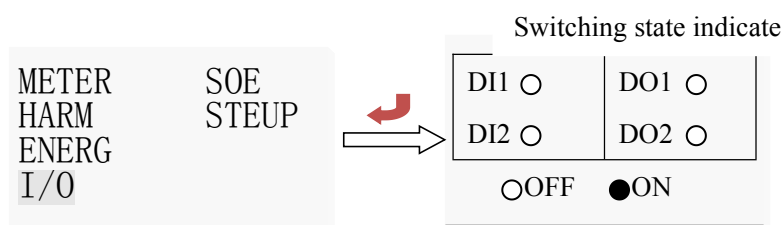

6.2.5 Incident record

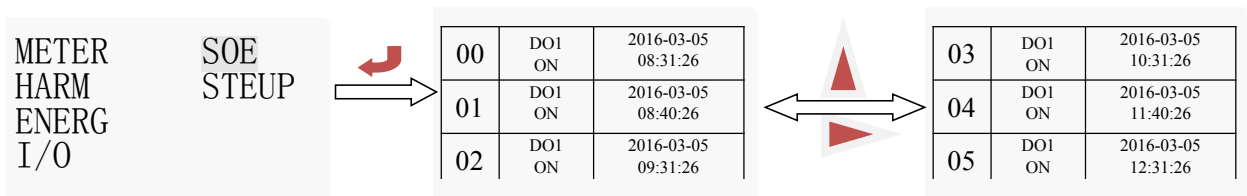

After selecting the event record, the instrument presses the enter key to display the action information of the switch input and output. As shown in the figure above, the record of Article 1 indicates the input score of the first switch at 8:31:26 on March 5, 16; Article 5 records indicate that the first switch input at 12:32:26 on March 5, 16 years, press the upper and lower keys to view other records, and save a total of 16 records.

6.2.6 Parameter setting

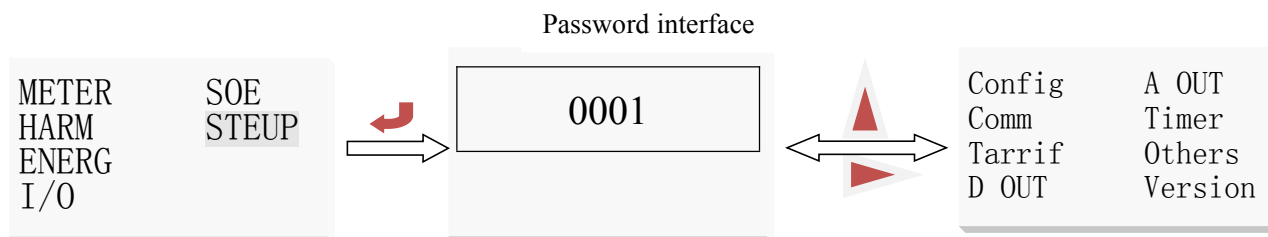

After enter the main menu, press the up key or the down key to select the user setting item, press enter key to appear the password input item, press the up key or the down key at this time, can make the cursor move on one, ten, hundred thousand bits, when the position is in the reserse white state, You can press the left and right key to add and subtract the digit, the password (default is 0001) enter correctly, press enter key to enter the user setup interface.

6.2.6.1 Parameter setting

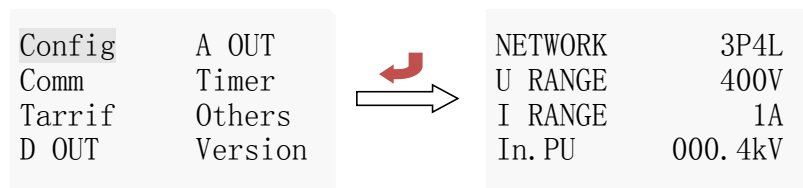

After entering the user setup interface, press the upper and lower keys to select the system settings, and then press enter to enter the system setting interface. Under the system setup interface, press the up and down keys to select the items that need to be changed so that they are in the reserse state.

	explain	remarks
NETWORK	Cinnection mode: three-phase four-wire, three-phase three-wire, single-phase	
U RANGE	Secondary voltage: 100V、400V	220V、380V all choose 400V
I RANGE	Internal calibration currunt coefficient	The customer is meaningless

		and does not need to be set up
In.PU	Primary voltage value	Unit: kV
In.PI	Primary current value	The customer can set according to the actual current
CODE	Password settin	Default 0001

Give an example:

Customer ordering model:voltage:10KV/100V, current:600A/5A, at this time,U RANGE shall be set to 100V, IN.PU is set to 10KV, ang IN.PI is set as 600.

6.2.6.2communication setting

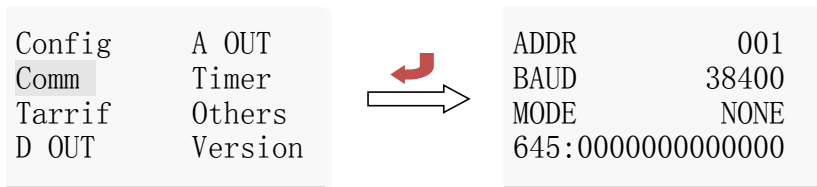

After entering the user setting interface,press the upper and downer keys to select the communication settings, and press the enter key to enter the communication settings interface. Press the itens that need to be changed under the communication setting interface to make it in the anti-white state press the key to change the communication address(1-247), the communication baud rate (1200bps, 2400bps, 4800bps, 9600bps, 19200bps, 48400bps), the check mode(no check, odd check even check, 2bits), 645 protocol address.

6.2.6.3Rate setting

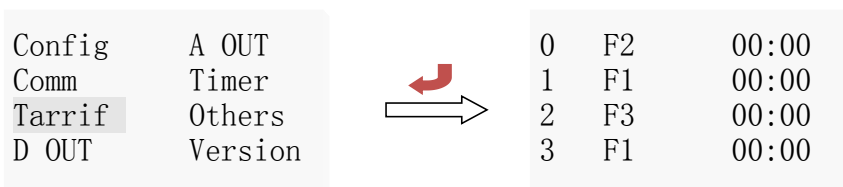

After entering the user setting interface,press the upper and louer keys to select the rate setting, and press the enter key to enter the rate setting interface. The dashboard housing sets two time zones, eight periods and nine periods, four rates(pesk flat valley). under the time zone setting interface,press the upper and lower keys to select the default value item, and press the left and right key to modify the setting item value.As shown below:

Notes:when setting the rate time,the later time must be larger than the previous time,otherwise there will be an error.

number	time	describe
1	00: 00	In the 00: 00~06: 00 time period, the rate is flat
2	06: 00	In the06: 00~08: 00 time period, the rate is valley
3	08: 00	In the08: 00~10: 00 time period, the rate is flat
4	10: 00	In the10: 00~12: 00 time period, the rate is peak

5	12: 00	In the12: 00~14: 00 time period, the rate is peak
6	14: 00	In the14: 00~16: 00 time period, the rate is flat
7	16: 00	In the16: 00~22: 00 time period, the rate is flat
8	22: 00	In the22: 00~00: 00 time period, the rate is sharp

6.2.6.4 Switch setting

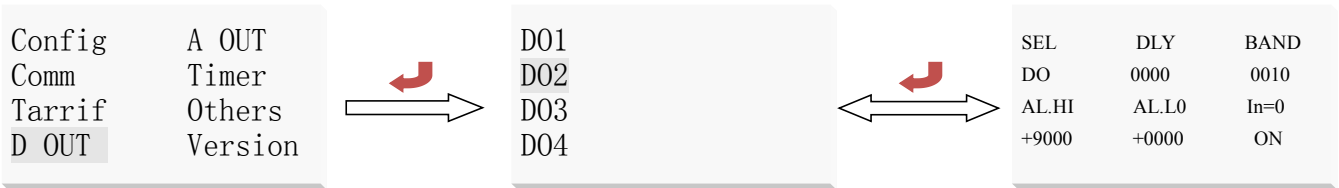

After entering the user setting interface, press the upper and lower keys to select the switch (D01-D04) settings, and press the enter key to enter the switch setting interface.

"SEL" set DO output type, "0.do" indicate communication control (and then in case DLY set as 0 output potential mode, or else pulse mode; in case DLY set as 2, auto disconnect in 0.02 seconds after closing), other alarm control (given in table below).

"dLy" as alarm delay (alarm setting not recommended as 0 to prevent error action due to interference)

"bAnd" no action interval

"AL.Hi" high alarm value setting (no setting of maximum 9999)

"AL.Lo" low alarm value setting (no setting of minimum -9999)

(three sets above correspond to electric energy readings and readings contain decimal point, e.g. input 220V 100A/5A, three phase four wire, 100%P total as $220 \times 100 \times 3 = 66\text{kW}$, e.g. 100% power high alarm, "AL.Hi" taken as 66.00; 100% voltage high alarm, "AL.Hi" taken as 220.0; 100% current high alarm, "AL.Hi" taken as 100.0)

"In.=0" whether the low alarm is allowed when the signal is 0, Lo.on enabled, Lo.of disabled.

First-way relay output								
SEL	0	Communication controlled DO output mode, "dLy" 0 means potential control; set as other value means auto return mode; auto disconnection after DO post action delay "dLy" (unit 0.01 second)						
	do							
	01	02	03	04	05	06	07	08
	U _A	U _B	U _C	Phase voltage alarm value	U _{AB}	U _{BC}	U _{CA}	Linear voltage alarm value
	09	10	11	12	13	14	15	16
	I _A	I _B	I _C	Current alarm value	PA	PB	PC	P 总
	17	18	19	20	21	22	23	24
	Q _A	Q _B	Q _C	Q 总	SA	SB	SC	S 总

	25	26	27	28	29	30	31	32
	PF _A	PF _B	PF _C	PF	F	Voltage unbalance	Current unbalance	Neutral line current
DLY	Output delay time In case of DO output mode, set as 0, potential control mode; set as non 0 pulse control mode, disconnection after delay set time, unit: 1 second;							
BAND	No action interval							
AL. Hi	Scope of high alarm value -9999~9999 (decimal point not considered)							
AL. Lo	Scope of low alarm value -9999~9999 (decimal point not considered)							
Lo. on	Lo.on signal 0, low alarm may be triggered Lo.oF signal 0, low alarm is not triggered							

Note: 1. Indication of three phase XX maximum/minimum value: high alarm represents maximum value of three phase; low alarm represents minimum value of three phase.

2.Second way DO to be set as "32.FL" combination alarm function; after setting, level II menu changed as "SEL" (function selection), "dLy" (delay), "H-U" (high voltage), "L-U" (low voltage), "H-F" (high frequency), "L-F" (low frequency), "H-P" (high frequency), "L-P" (low frequency), "H-I" (high current), "L-PF" (low power factor), " H-b.U" (over voltage unbalance, set as -1 phase miss, judgement condition at least one phase>0.5Ue, at least one phase<0.1Ue), " H-b.I" (over current unbalance, set as -1 phase miss,judgement condition at least one phase>0.2Ie., at least one phase<0.01Ie).

3.Unbalance calculation

(Difference between maximum deviation from the mean value and mean value)/mean value *100%, if the mean value of denominator is less than the rated value, the denominator is rated value; voltage rated value Ue; 3 phase 4 wire Ue as the phase voltage, menu setting 400V instrument as 220V*PT, 100V instrument as 57V*PT. Current rated value Ie: 5A instrument as 5A*CT, 1A instrument as 1A*CT.

Unbalance set parameter in percentage, e.g. 20 means 20%

6.2.6.5Transmission setting (Function not available for the time being)

```
Config  A OUT
Comm    Timer
Tarrif  Others
D OUT   Version
```

6.2.6.6Event setting

```
Config  A OUT
Comm    Timer
Tarrif  Others
D OUT   Version
```

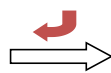

```
2016-03-16
12: 34: 15
BlacLight ON
```

进入用户设置界面后,

Press the up and down keys to select the time setting, and then press Enter to enter the setting interface. After entering the time setting interface, press the up and down keys to select the item to be set, and press the left and right keys to modify the setting item value.

Note: illegal time cannot be saved (for example, illegal time cannot be entered at 25:05 on January 5, 2008)

6.2.4.7 Other setting

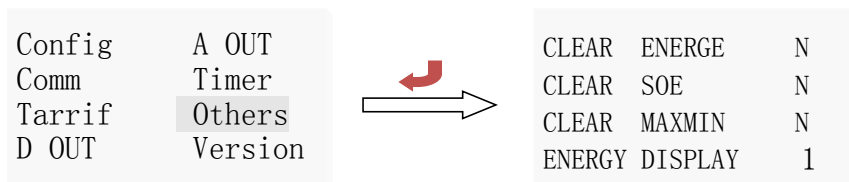

After entering user setting interface, press the Up/Down button to select other setting, then press Enter key to enter other setting interface. After entering Time setting interface, press the Up/Down button to select item to be set, press the Left/Right button to revise setting item value. KWH-value zero clearing interface include to set Meter reading day, to clear energe, soe, maxmin and energy display.

Note: when clearing KWH-value, select "Yes" and press Enter key, then Electric energy will be zero clearing and can not be restored.

Version information: after power on the version information is displaying, under this interface, user can look over the related version information.

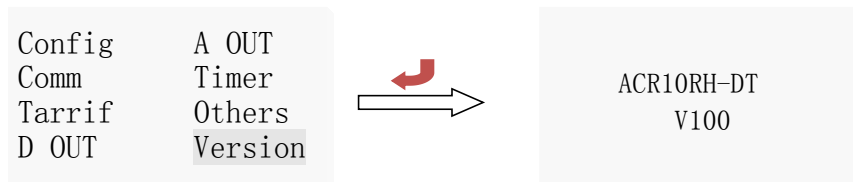

7. Communication wiring

The instrument provides asynchronous half-duplex RS485 communication interface, using MODBUS-RTU protocol, all kinds of data information can be transmitted on the communication line, theoretically, how many large instruments can be connected at the same time on one line, Each instrument can set its communication address (Addr), communication rate (baud) can also be selected by setting.

It is suggested that two-core shielding line should be used to connect A and B, and the shielding layer should be connected to the earth respectively. When wiring, the communication line should be used to stay away from the strong electric cable or other strong electric field environment.

It's recommended that the matching resistance shall be added between the foremost and instruments A, B and the rated resistance range is 120Ω~10 kΩ.

Wiring for other settings:

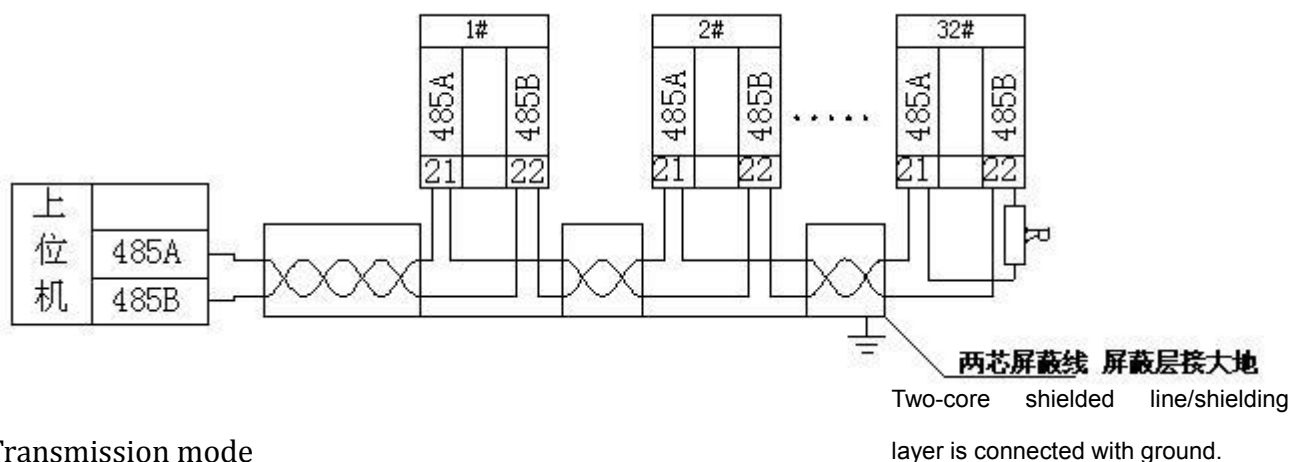

7.1 Transmission mode

The information is transmitted asynchronous and in bytes, and the communication information transmitted between the host and the slave is in a 10-bit word format, including 1 start bit, 8 data bits (the smallest valid bit is sent first), no parity check bit, 1 stop bit, set to parity bit or 2 bit stop bit, 11 bit word format.

7.2 Information frame format

Address Code	Function Code	Data Field	CRC check code
1 byte	1 byte	N bytes	2 bytes

Address code: the address code is at the beginning of the frame and consists of one byte (8 bit binary code). The decimal bit is 0-255. Only 1-247 is used in the PZ instrument, and the other addresses are reserved. These bits indicate the address of the user-specified terminal device, which will receive data from the host connected to it. The address of each terminal device must be unique, and only the addressed terminal will respond to a query containing that address. When the terminal sends back a response, the slave address data in the response tells the host which terminal is communication with it.

Function code: the function code tells the addressable terminal what function to perform. The following table lists the functional codes used in this series of instruments, as well as their significance and functions.

Dunction	Definition	Operate
03H/04H	Read data registe	Get the current binary value of one or more registers
10H	Preset multi-registe	Set binary values into a series of multiple registers

Data area: the data area contains the data needed by the terminal to perform a specific function or the data collected by the terminal in response to the query. The content of this data may be a

numerical value, a reference address, or a setting value. For example, the function code tells the terminal to read a register, the data area needs to indicate which register to start from and how many data to read, and the embedded address and data vary according to the type and the content between the slave machine.

CRC check code: the error check (CRC) domain takes up two bytes and contains a 16-bit binary value. CRC values are calculated by the transmission device and then appended to the data frame, and the receiving the data. Then compared with the received value in the CRC domain, if the two values are not equal, an error occurs.

The process for generating a CRC is:

- a、Preset a 16-bit register to 0FFFFH (FULL 1), called CRC register.
- b、XOR the 8 bits of the first byte in the data frame with the low byte in the CRC register, and the result is saved back to the CRC register.
- c、Move the CRC register one bit to the right, fill in the highest bit with 0, and the lowest displacement is out and detected.
- d、If the lowest is 0, repeat the third step (next shift); if the lowest is 1, XOR the CRC register to a preset fixed value (0A001H).
- e、Repeat steps 3 and 4 until 8 shifts. In this way, a complete eight digits have been dealt with.
- f、Repeat steps 2 to 5 to process the next eight bits until all byte processing is over.
- g、Finally, the value of the CRC register is the value of CRC.

In addition, there is also a method of calculating CRC using preset tables, the main feature of which is that the calculation speed is fast, but the table requires a large storage space. This method is not repeated here, see the relevant information.

7.3 Brief introduction of function code

7.3.1 Function code 03H: read register

This feature allows users to obtain data and system parameters that are captured and recorded by the device, with no limit on the number of data requested by the host at a time, but not beyond the defined address range.

The following example is the basic data collected from three machine-readable data from NO. 01 (2 byte per address in the data frame) where the address of UAB is 246 (F6H), UBC is 247 (F7H), UCA is 248 (F8H).

Host send	Send information	Return from the machine	Return information
Address code	01H	Address code	01H

Function code		03H
Start address	High byte	00H
	Low byte	F6H
Number of registers	High byte	00H
	Low byte	03H
CRC check code	Low byte	E5H
	High byte	F9H

Function code		03H
Byte number		06H
Register data	High byte	underrange
	Low byte	underrange
Register data	High byte	underrange
	Low byte	underrange
Register data	High byte	underrange
	Low byte	underrange
CRC check code	Low byte	underrange
	High byte	underrange

7.4 Communication application details

In the design of the instrument, the communication address table is unified. According to the following introduction, the user can conveniently realize the functions of telemetry, remote communication, remote control and so on.

7.4.1 Communication description

Communication of ACR Harmonic meters adopt MODBUS-RTU Communication protocol, MODBUS protocol define check code, data sequence etc. In detail, these are necessary content for specific data exchange.

Address	Name	Type	Note	word
0	Meter address	R/W	Network node meter Address (001--127)	1
1	Communication speed	R/W	0--4800bps 3--38400bps(Default Communication speed). 1--9600bps 4--2400bps 2--19200bps 5--1200bps	1
2	Communication check mod	R/W	0--No parity bit(Default mode) 1-Odd parity bit; 2-Even parity bit 3--2 bits	1
3	Wiring mode	R/W	0--3-phase 3--wire 1--3-phase 4-wire.	1
4	Secondary side rated voltage Ue	R/W	0--100V 2--660V 1--400V	1
5	Secondary side rated current value Ie	R/W	0--1A	1
6	Primary side rated voltage PU	R/W	1~65000, decimal point 2 digits , corresponding 0.01-650.00kV	1
7	Primary side rated current value PI	R/W	1~65000A	1
8	Backlight delay time	R/W	Setting as 0, backlight lights; Setting as 1-255, after 1-255 seconds backlight go out.	1
9	Relay 1 delay time	R/W	Setting as 0, relay 1 adopt level control mode; Setting as 1-255, relay adopt pulse control mode, Unit :0.01second.	1
10	Relay 2 delay time	R/W		1
11	Relay 3 delay time	R/W		1
12	Relay 4 delay time	R/W		1
14-15	Voltage primary side and	R	Float mould	2

	secondary side coefficient			
16-17	Primary side and secondary side coefficient of current	R	Float mould	2
18-19	Power,primary and secondary side coefficients	R	Float mould	2
21-23	Multi-rate time period 1	R/W	Information about multi-rate:8 time period、4 rates; Each period of time occupies 3 bytes:the first byte is for hour、 the second is for minute、 the third is for rate; four rates: 0-tip, 1-peak,2-Flat, 3-valley.	3
24-26	Multi-rate time period 2	R/W		3
27-29	Multi-rate time period 3	R/W		3
30-32	Multi-rate time period 4	R/W		3
33-35	Multi-rate time period 5	R/W		3
36-38	Multi-rate time period 6	R/W		3
39-41	Multi-rate time period 7	R/W		3
42-44	Multi-rate time period 8	R/W		3
53	First channel Switching input	RO	Switching as 1,non-switching as 0.	1
54	Second channel Switching input	RO		1
55	Third channel Switching input	RO		1
56	Fourth channel Switching input	RO		1
57	Fifth channel Switching input	RO		1
58	Sixth channel Switching input	RO		1
59	Seventh channel Switching input	RO		1
60	Eighth channel Switching input	RO		1
61	First channel Switching output	R/W	Writing 1,Output relay contact is closed, Writing 0,Output relay contact is opening.	1
62	Second channel Switching output	R/W	Writing 1,Output relay contact is closed, Writing 0,Output relay contact is opening.	1
63	Third channel Switching output	R/W	Writing 1,Output relay contact is closed, Writing 0,Output relay contact is opening.	1
64	Fourth channel Switching output	R/W	Writing 1,Output relay contact is closed, Writing 0,Output relay contact is opening.	1
128	Year	R/W	Time://BCD code format. Setting time requires the use of the 10H command to set all the time	1
129	Month	R/W		1
130	Day	R/W		1
131	Hour	R/W		1
132	Minute	R/W		1

133	Second	R/W		1
143-148	Event record 1	RO	retain	6
149-154	Event record 2	RO	retain	6
155-160	Event record 3	RO	retain	6
161-166	Event record 4	RO	retain	6
167-172	Event record 5	RO	retain	6
173-178	Event record 6	RO	retain	6
179-184	Event record 7	RO	retain	6
185-190	Event record 8	RO	retain	6
191-196	Event record 9	RO	retain	6
197-202	Event record 10	RO	retain	6
203-208	Event record 11	RO	retain	6
209-214	Event record 12	RO	retain	6
215-220	Event record 13	RO	retain	6
221-226	Event record 14	RO	retain	6
227-232	Event record 15	RO	retain	6
233-238	Event record 16	RO	retain	6
242	Neutral current	RO	Secondary side Current decimal Point digital:3	1
243	Phase Voltage Uan	RO	Secondary side Voltage decimal Point digital:1	1
244	Phase Voltage Ubn	RO	Secondary side	1
245	Phase Voltage Ucn	RO	Secondary side	1
246	Line Voltage Uab	RO	Secondary side	1
247	Line Voltage Ubc	RO	Secondary side	1
248	Line Voltage Uca	RO	Secondary side	1
249	Phase Current Ia	RO	Secondary side Current decimal Point digital:3	1
250	Phase Current Ib	RO	Secondary side	1
251	Phase Current Ic	RO	Secondary side	1
252	Frequency F	RO	Frequency decimal Point digital:2	1
253-254	Phase A Active power Pa	RO	Secondary side power decimal, Point digital:2, unit:W	2
255-256	Phase B Active power Pb	RO	Secondary side power decimal, Point digital:2, unit:W	2

257-258	Phase C Active power Pc	R0	Secondary side power decimal , Point digital:2, unit:W	2
259-260	Total.Active power PTotal	R0	Secondary side power decimal , Point digital:2, unit:W	2
261-262	Phase A Reactive power Qa	R0	Secondary side power decimal , Point digital:2, unit:var	2
263-264	Phase B Reactive power Qb	R0	Secondary side power decimal , Point digital:2, unit:var	2
265-266	Phase C Reactive power Qc	R0	Secondary side power decimal , Point digital:2, unit:var	2
267-268	TotalReactive power QTotal	R0	Secondary side power decimal , Point digital:2, unit:var	2
269-270	Phase A Apparent powerSa	R0	Secondary side power decimal , Point digital:2, unit:VA	2
271-272	Phase B Apparent powerSb	R0	Secondary side power decimal , Point digital:2, unit:VA	2
273-274	Phase C Apparent powerSc	R0	Secondary side power decimal , Point digital:2, unit:VA	2
275-276	TotalApparent power STotal	R0	Secondary side power decimal , Point digital:2, unit:VA	2
277	Phase A power factor	R0	power factordecimal Point digital:3	1
278	Phase B power factor	R0		1
279	Phase C power factor	R0		1
280	Total power factor	R0		1
287	Phase A Current K factor	R0	K factor decimal Point digital:2	1
288	Phase B Current K factor	R0		1
289	Phase C Current K factor	R0		1
299	Unbalance factor of voltage	R0	Unbalance factor of voltage decimal Point digital:1	1
300	Unbalance factor of current	R0	Unbalance factor of current decimal Point digital:1	1
301-302	Maximum demand	R0	Maximum demand decimal Point digital:2	2
303-306	Maximum demand occurrence time	R0	Time;// BCD code format	4
333-334	This month active Peak Electric energy	R0	Secondary side Electric energy 2-bit decimal Point, unit:kWh	2

335-336	This month active Flat Electric energy	RO	Secondary side Electric energy 2-bit decimal Point, unit:kWh	2
337-338	This month active Valley Electric energy	RO	Secondary side Electric energy 2-bit decimal Point, unit:kWh	2
339-340	This month active Total Electric energy	RO	Secondary side Electric energy 2-bit decimal Point, unit:kWh	2
341-342	Last month active Peak Electric energy	RO	Secondary side Electric energy 2-bit decimal Point, unit:kWh	2
343-344	Last month active Flat Electric energy	RO	Secondary side Electric energy 2-bit decimal Point, unit:kWh	2
345-346	Last month active Valley Electric energy	RO	Secondary side Electric energy 2-bit decimal Point, unit:kWh	2
347-348	Last month active Total Electric energy	RO	Secondary side Electric energy 2-bit decimal Point, unit:kWh	2
349-350	Month before last active Peak Electric energy	RO	Secondary side Electric energy 2-bit decimal Point, unit:kWh	2
351-352	Month before last active Flat Electric energy	RO	Secondary side Electric energy 2-bit decimal Point, unit:kWh	2
353-354	Month before last active Valley Electric energy	RO	Secondary side Electric energy 2-bit decimal Point, unit:kWh	2
355-356	Month before last active Total Electric energy	RO	Secondary side Electric energy 2-bit decimal Point, unit:kWh	2
357-358	Total active Peak Electric energy	RO	Secondary side Electric energy 2-bit decimal Point, unit:kWh	2
359-360	Total active Flat Electric energy	RO	Secondary side Electric energy 2-bit decimal Point, unit:kWh	2
361-362	Total active Valley Electric energy	RO	Secondary side Electric energy 2-bit decimal Point, unit:kWh	2
363-364	Total multi-rate active Electric energy	RO	Secondary side Electric energy 2-bit decimal Point, unit:kWh	2
365-366	Forward active Electric energy EPI	RO	Secondary side Electric energy 2-bit decimal Point, unit:kWh	2
367-368	Backward active Electric energy EPE	RO	Secondary side Electric energy 2-bit decimal Point, unit:kWh	2
369-370	Forward reactive Electric energy EQI	RO	Secondary side Electric energy 2-bit decimal Point, unit:kWh	2

371-372	Backward reactive Electric energy EQC	RO	Secondary side Electric energy 2-bit decimal Point, unit:kWh	2
373-402	A Phase Voltage 2-31 order harmonic ratio	RO	A Phase Voltage 2-31 order harmonic;2-bit decimal point	30
403-432	B Phase Voltage 2-31 order harmonic ratio	RO	A Phase Voltage 2-31 order harmonic;2-bit decimal point	30
433-462	C Phase Voltage 2-31 order harmonic ratio	RO	C Phase Voltage 2-31 order harmonic ,2-bit decimal point	30
463-492	A Phase Current 2-31 order harmonic ratio	RO	A Phase Current 2-31 order harmonic,2-bit decimal point	30
493-522	B Phase Current 2-31 order harmonic ratio	RO	B Phase Current 2-31 order harmonic,2-bit decimal point	30
523-552	C Phase Current 2-31 order harmonic ratio	RO	C Phase Current 2-31 order harmonic,2-bit decimal point	30
553	A Phase Voltage Total harmonic distortion	RO	A Phase Voltage Total harmonic content;decimal point digital:2	1
554	B Phase Voltage Total harmonic distortion	RO	B Phase Voltage Total harmonic content;decimal point digital:2	1
555	C Phase Voltage Total harmonic distortion	RO	C Phase Voltage Total harmonic content;decimal point digital:2	1
556	A Phase Current Total harmonic distortion	RO	A Phase Current Total harmonic content;decimal point digital:2	1
557	B Phase Current Total harmonic distortion	RO	B Phase Current Total harmonic content;decimal point digital:2	1
558	C Phase Current Total harmonic distortion	RO	C Phase Current Total harmonic content;decimal point digital:2	1
559-590	A Phase Voltage sampling point(32 point/wave)	RO	A Phase Voltage sampling point	32
591-622	B Phase Voltage sampling point(32 point/wave)	RO	B Phase Voltage sampling point	32
623-654	C Phase Voltage sampling point(32 point/wave)	RO	C Phase Voltage sampling point	32
655-686	A Phase Current sampling point(32 point/wave)	RO	A Phase Current sampling point	32
687-718	B Phase Current sampling point(32 point/wave)	RO	B Phase Current sampling point	32

719-750	C Phase Current sampling point(32 point/wave)	R0	C Phase Current sampling point	32
1000	DIDO state	R/W	High bytes DI (bit 0 as DI1, bit 1 as DI2, like this, bit 7 as DI8), low bytes DO (bit 0 as DO1, bit 1 as DO2, like this, bit 7 as DO8)	1
1001	First way alarm selection	R/W	0-32, details given in correlation in table 7.1.5, e.g. total active power alarm, value 16	1
1002	First way alarm delay	R/W	0-9999 unit: s; e.g. total active power alarm, the value being 16	1
1003	First way alarm dead zone	R/W	-9999 – 9999 details given in 7.1.5, e.g. reading 66.00Kw, communication value 6600	1
1004	First way high alarm	R/W		1
1005	First way low alarm	R/W		1
1006	First way 0 alarm	R/W	0 – 1 (0: enabled, 1: disabled)	1
1007-1012	Second way (same as above)	R/W	One more combination alarm selection than the first way, type selection 0-33 (in case of value 33, corresponding set address 1030-1037 effective), the remaining same as first way	6
1013-1018	Third way (same as above)	R/W	Same as first way	6
1019-1024	Fourth way (same as above)	R/W	Same as above	6
1030	Over frequency	R/W	-9999 – 9999 only effective when the second way alarm is the combination alarm, details given in 7.1.5; e.g. reading 66.00Kw, communication value 6600	1
1031	Under frequency	R/W		1
1032	Over power	R/W		1
1033	Under power	R/W		1
1034	Over current	R/W		1
1035	Under power factor	R/W		1
1036	Over voltage unbalance	R/W		-1 – 9999 details given in 7.1.5, e.g.: reading 55.00Kw, communication value 5500
1037	Over current unbalance	R/W	1	
1038	Combination alarm state	R0	0 bit indicates over voltage alarm state, first bit indicates under voltage alarm state, in the same manner till bit 9	1
1040	First way transmission selection (low bytes effective)	R/W		1
1041	First way high transmission	R/W		1
1042	First way low transmission	R/W		1

1043-1045	Second way transmission	R/W		3
1046-1048	Third way transmission	R/W		3
1049-1051	Fourth way transmission	R/W		3
1100-1102	DLT/645 address	R/W		3
1103	Second way communication speed	R/W	0--4800bps; 4--2400bps 1--9600bps; 5--1200bps 2--19200bps; 3--38400bps (default communication speed).	1
1104	Second way communication calibration mode	R/W	0--no calibration bit (default mode) ; 1--odd calibration bit; 2--even calibration bit. 3--2 bits	1
1200-1211	Time interval 1 parameter	R/W	Time interval 1 has 8 time periods; each time period takes 1.5 character, the first byte being time, second byte being minute, third byte being rate type, four rates separately being 0-tip, 1-peak, 2-flat, 3-trough	27
1212-1225	Time interval 2 parameter		Time interval 1 has 9 time periods; each time period takes 1.5 character, the first byte being time, second byte being minute, third byte being rate type, four rates separately being 0-tip, 1-peak, 2-flat, 3-trough	
1225-1226	Time interval type selection		1225 low 8 bit being January-August time interval selection, eighth bit being January time interval selection, (0: select time interval 1, 1: select time interval 2), in the similar manner, bit 1being August time interval selection; 1226 high 4 bit September-December time interval selection, bit 16 being September time interval selection, in the similar manner, bit 13 being December time interval selection (0: select time interval 1, 1: select time interval 2)	
1250-1251	Historical active tip electric	R0	Secondary electric energy, 2-bit decimal	2

	energy in January		points	
1252-1253	Historical active peak electric energy in January	RO	Same as above	2
1254-1255	Historical active flat electric energy in January	RO	Same as above	2
1256-1257	Historical active trough electric energy in January	RO	Same as above	2
1258-1259	Historical total active electric energy in January	RO	Same as above	2
1260-1269	Historical active electric energy in February	RO	Same as above	10
1270-1279	Historical active electric energy in March	RO	Same as above	10
1280-1289	Historical active electric energy in April	RO	Same as above	10
1290-1299	Historical active electric energy in May	RO	Same as above	10
1300-1309	Historical active electric energy in June	RO	Same as above	10
1310-1319	Historical active electric energy in July	RO	Same as above	10
1320-1329	Historical active electric energy in August	RO	Same as above	10
1330-1339	Historical active electric energy in September	RO	Same as above	10
1340-1349	Historical active electric energy in October	RO	Same as above	10
1350-1359	Historical active electric energy in November	RO	Same as above	10
1360-1369	Historical active electric energy in December	RO	Same as above	10
1370-1379	Total active electric energy	RO	Same as above	10
2000-2061	Phase A voltage 2-63 harmonic content	RO	Phase A voltage 2-63 harmonic; decimal points: 2	62
2062-2123	Phase B voltage 2-63 harmonic content	RO	Phase B voltage 2-63 harmonic; decimal points: 2	62

2124-2185	Phase C voltage 2-63 harmonic content	R0	Phase C voltage 2-63 harmonic; decimal points: 2	62
2186-2247	Phase A current 2-63 harmonic content	R0	Phase A current 2-63 harmonic; decimal points: 2	62
2248-2309	Phase B current 2-63 harmonic content	R0	Phase B current 2-63 harmonic; decimal points: 2	62
2310-2371	Phase C current 2-63 harmonic content	R0	Phase C current 2-63 harmonic; decimal points: 2	62
2372	Phase A voltage total harmonic distortion	R0	Phase A voltage total harmonic content; decimal points: 2	1
2373	Phase B voltage total harmonic distortion	R0	Phase B voltage total harmonic content; decimal points: 2	1
2374	Phase C voltage total harmonic distortion	R0	Phase C voltage total harmonic content; decimal points: 2	1
2375	Phase A current total harmonic distortion	R0	Phase A current total harmonic content; decimal points: 2	1
2376	Phase B current total harmonic distortion	R0	Phase B current total harmonic content; decimal points: 2	1
2377	Phase C current total harmonic distortion	R0	Phase C current total harmonic content; decimal points: 2	1

3000	High byte	Decimal point U (DPT)	R0	3-7	0.5
3000	Low byte	Decimal point I (DCT)	R0	1-5	0.5
3001	High byte	Decimal point PQ(DPQ)	R0	4-10	0.5
3001	Low byte	Symbol PQ	R0	high bit-low bit: Q、Qc、Qb、Qa、P、Pc、Pb、Pa 0 is positive, 1 is negative	0.5
3002		Phase voltage average	R0	primary side	1
3003		Line voltage average	R0	primary side	1
3004		Current average	R0	primary side	1
3008-3009		System uptime	R/W	In seconds, the high byte before, and the low byte in the back.	2
3010		phase voltage Uanmaximum	R0	primary side	1

3011	Generation time: year、 month	RO	High 8: year ; low 8: month	1
3012	Generation time: day,hour	RO	High 8: day ; low 8: hour	1
3013	Generation time: minutes, seconds	RO	High 8: minutes ; low 8: seconds	1
3014	phase voltage U _{bn} maximum	RO	primary side	1
3015	Generation time: year、 month	RO	High 8: year ; low 8: month	1
3016	Generation time: day,hour	RO	High 8: day ; low 8: hour	1
3017	Generation time: minutes, seconds	RO	High 8: minutes ; low 8: seconds	1
3018	phase voltage U _{cn} maximum	RO	primary side	1
3019	Generation time: year、 month	RO	High 8: year ; low 8: month	1
3020	Generation time: day,hour	RO	High 8: day ; low 8: hour	1
3021	Generation time: minutes, seconds	RO	High 8: minutes ; low 8: seconds	1
3022	line voltage U _{ab} maximum	RO	primary side	1
3023	Generation time: year、 month	RO	High 8: year ; low 8: month	1
3024	Generation time: day,hour	RO	High 8: day ; low 8: hour	1
3025	Generation time: minutes, seconds	RO	High 8: minutes ; low 8: seconds	1
3026	line voltage U _{bc} maximum	RO	primary side	1
3027	Generation time: year、 month	RO	High 8: year ; low 8: month	1
3028	Generation time: day,hour	RO	High 8: day ; low 8: hour	1
3029	Generation time: minutes, seconds	RO	High 8: minutes ; low 8: seconds	1
3030	line voltage U _{ca} maximum	RO	primary side	1
3031	Generation time:	RO	High 8: year ; low 8: month	1

	year、 month			
3032	Generation time:	RO	High 8: day ; low 8: hour	1
3033	Generation time: minutes, seconds	RO	High 8: minutes ; low 8: seconds	1
3034	Phase Current Ia maximum	RO	primary side	1
3035	Generation time: year、 month	RO	High 8: day ; low 8: hour	1
3036	Generation time: day,hour	RO	High 8: day ; low 8: hour	1
3037	Generation time: minutes, seconds	RO	High 8: minutes ; low 8: seconds	1
3038	Phase Current Ib maximum	RO	primary side	1
3039	Generation time: year、 month	RO	High 8: year ; low 8: month	1
3040	Generation time: day,hour	RO	High 8: day ; low 8: hour	1
3041	Generation time: minutes, seconds	RO	High 8: minutes ; low 8: seconds	1
3042	Phase Current Ic maximum	RO	primary side	1
3043	Generation time: year、 month	RO	High 8: year ; low 8: month	1
3044	Generation time: day,hour	RO	High 8: day ; low 8: hour	1
3045	Generation time: minutes, seconds	RO	High 8: minutes ; low 8: seconds	1
3046	A active power Pa maximum	RO	primary side	1
3047	Generation time: year、 month	RO	High 8: year ; low 8: month	1
3048	Generation time: day,hour	RO	High 8: day ; low 8: hour	1
3049	Generation time: minutes, seconds	RO	High 8: minutes ; low 8: seconds	1
3050	B active power Pb maximum	RO	primary side	1
3051	Generation time: year、 month	RO	High 8: year ; low 8: month	1

3052	Generation time: day,hour	R0	High 8: day ; low 8: hour	1
3053	Generation time: minutes, seconds	R0	High 8: minutes ; low 8: seconds	1
3054	C active power Pc maximum	R0	primary side	1
3055	Generation time: year、 month	R0	High 8: year ; low 8: month	1
3056	Generation time: day,hour	R0	High 8: day ; low 8: hour	1
3057	Generation time: minutes, seconds	R0	High 8: minutes ; low 8: seconds	1
3058	Total active power P maximum	R0	primary side	1
3059	Generation time: year、 month	R0	High 8: year ; low 8: month	1
3060	Generation time: day,hour	R0	High 8: day ; low 8: hour	1
3061	Generation time: minutes, seconds	R0	High 8: minutes ; low 8: seconds	1
3062	Phase A Reactive power Qamaximum	R0	primary side	1
3063	Generation time: year、 month	R0	High 8: year ; low 8: month	1
3064	Generation time: day,hour	R0	High 8: day ; low 8: hour	1
3065	Generation time: minutes, seconds	R0	High 8: minutes ; low 8: seconds	1
3066	Phase B Reactive power Qb maximum	R0	primary side	1
3067	Generation time: year、 month	R0	High 8: year ; low 8: month	1
3068	Generation time: day,hour	R0	High 8: day ; low 8: hour	1
3069	Generation time: minutes, seconds	R0	High 8: minutes ; low 8: seconds	1
3070	Phase C Reactive power Qc maximum	R0	primary side	1

3071	Generation time: year、 month	RO	High 8: year ; low 8: month	1
3072	Generation time: day,hour	RO	High 8: day ; low 8: hour	1
3073	Generation time: minutes, seconds	RO	High 8: minutes ; low 8: seconds	1
3074	Total.Reactive power QTotalmaximum	RO	primary side	1
3075	Generation time: year、 month	RO	High 8: year ; low 8: month	1
3076	Generation time: day,hour	RO	High 8: day ; low 8: hour	1
3077	Generation time: minutes, seconds	RO	High 8: minutes ; low 8: seconds	1
3078	Phase A Apparent powerSamaximum	RO	primary side	1
3079	Generation time: year、 month	RO	High 8: year ; low 8: month	1
3080	Generation time: day,hour	RO	High 8: day ; low 8: hour	1
3081	Generation time: minutes, seconds	RO	High 8: minutes ; low 8: seconds	1
3082	Phase B Apparent powerSb maximum	RO	primary side	1
3083	Generation time: year、 month	RO	High 8: year ; low 8: month	1
3084	Generation time: day,hour	RO	High 8: day ; low 8: hour	1
3085	Generation time: minutes, seconds	RO	High 8: minutes ; low 8: seconds	1
3086	Phase C Apparent powerSc maximum	RO	primary side	1
3087	Generation time: year、 month	RO	High 8: year ; low 8: month	1
3088	Generation time: day,hour	RO	High 8: day ; low 8: hour	1

3089	Generation time: minutes, seconds	R0	High 8: minutes ; low 8: seconds	1
3090	TotalApparent power STotalmaximum	R0	primary side	1
3091	Generation time: year、 month	R0	High 8: year ; low 8: month	1
3092	Generation time: day,hour	R0	High 8: day ; low 8: hour	1
3093	Generation time: minutes, seconds	R0	High 8: minutes ; low 8: seconds	1
3094	Phase A power factormaximum	R0	power factor.decimal Point digital:3	1
3095	Generation time: year、 month	R0	High 8: year ; low 8: month	1
3096	Generation time: day,hour	R0	High 8: day ; low 8: hour	1
3097	Generation time: minutes, seconds	R0	High 8: minutes ; low 8: seconds	1
3098	Phase B power factormaximum	R0		1
3099	Generation time: year、 month	R0	High 8: year ; low 8: month	1
3100	Generation time: day,hour	R0	High 8: day ; low 8: hour	1
3101	Generation time: minutes, seconds	R0	High 8: minutes ; low 8: seconds	1
3102	Phase C power factormaximum	R0		1
3103	Generation time: year、 month	R0	High 8: year ; low 8: month	1
3104	Generation time: day,hour	R0	High 8: day ; low 8: hour	1
3105	Generation time: minutes, seconds	R0	High 8: minutes ; low 8: seconds	1
3106	Frequencymaximum	R0	Frequency decimalPoint digital:2	1
3107	Generation time:	R0	High 8: year ; low 8: month	1

	year、 month			
3108	Generation time: day,hour	RO	High 8: day ; low 8: hour	1
3109	Generation time: minutes, seconds	RO	High 8: minutes ; low 8: seconds	1
3110	Maximum current of neutral line	RO	Secondary side Current decimal Point digital:3	1
3111	Generation time: year、 month	RO	High 8: year ; low 8: month	1
3112	Generation time: day,hour	RO	High 8: day ; low 8: hour	1
3113	Generation time: minutes, seconds	RO	High 8: minutes ; low 8: seconds	1
3114	A Phase Voltage Total harmonic distortionmaximum	RO	A Phase Voltage Total harmonic content;decimal point digital:2	1
3115	Generation time: year、 month	RO	High 8: year ; low 8: month	1
3116	Generation time: day,hour	RO	High 8: day ; low 8: hour	1
3117	Generation time: minutes, seconds	RO	High 8: minutes ; low 8: seconds	1
3118	B Phase Voltage Total harmonic distortionmaximum	RO	B Phase Voltage Total harmonic content;decimal point digital:2	1
3119	Generation time: year、 month	RO	High 8: year ; low 8: month	1
3120	Generation time: day,hour	RO	High 8: day ; low 8: hour	1
3121	Generation time: minutes, seconds	RO	High 8: minutes ; low 8: seconds	1
3122	C Phase Voltage Total harmonic distortionmaximum	RO	C Phase Voltage Total harmonic content;decimal point digital:2	1
3123	Generation time: year、 month	RO	High 8: year ; low 8: month	1
3124	Generation time: day,hour	RO	High 8: day ; low 8: hour	1
3125	Generation time:	RO	High 8: minutes ; low 8: seconds	1

	minutes, seconds			
3126	A Phase Current Total harmonic distortionmaximum	RO	A Phase Current Total harmonic content;decimal point digital:2	1
3127	Generation time: year、 month	RO	High 8: year ; low 8: month	1
3128	Generation time: day,hour	RO	High 8: day ; low 8: hour	1
3129	Generation time: minutes, seconds	RO	High 8: minutes ; low 8: seconds	1
3130	B Phase Current Total harmonic distortionmaximum	RO	B Phase Current Total harmonic content;decimal point digital:2	1
3131	Generation time: year、 month	RO	High 8: year ; low 8: month	1
3132	Generation time: day,hour	RO	High 8: day ; low 8: hour	1
3133	Generation time: minutes, seconds	RO	High 8: minutes ; low 8: seconds	1
3134	C Phase Current Total harmonic distortionmaximum	RO	C Phase Current Total harmonic content;decimal point digital:2	1
3135	Generation time: year、 month	RO	High 8: year ; low 8: month	1
3136	Generation time: day,hou	RO	High 8: day ; low 8: hour	1
3137	Generation time: minutes, seconds	RO	High 8: minutes ; low 8: seconds	1

Note : 1、 Read/Write attribute: “ RO ” read only, this parameter use 03H command; “ R/W ” Read/Write ,system parameter use 10H command, Read in address, which is not listed or without Read/Write attribute, is forbidden.

2.Meter data adopt fixed_point number, decimal point digital see Address table;voltage/current harmonic data adopt percentage.

7.5 Communication reading value Vs actual value(Take Val_t as Communication reading value,Val_sas actual value)

7.5.1 Voltage,current,power factor ,frequency

This series measuring value is read out by Modbus-RTU protocol 03 command,each item occupy one word.Relation between communication value and actual value(secondary side measuring) is shown as below

table:

Applied parameter	Relation	Unit
Voltage U_{an} 、 U_{bn} 、 U_{cn} 、 U_{ab} 、 U_{bc} 、 U_{ca}	$Val_s = Val_t * PU / U_e$	V
Current I_A 、 I_B 、 I_C	$Val_s = Val_t * PI / 1000$	A
Power factor PF_A 、 PF_B 、 PF_C 、 $PF_{总}$	$Val_s = Val_t / 1000$	None
Frequency FR	$Val_s = Val_t / 100$	Hz

Example 1: Read a phase voltage UAN, read the data stored in the address 243 column to read the data, that is, the communication read out value $Val_t = 3800$, read $PU = 100$, $U_e = 400$, so $Val_s = Val_t * PU / U_e = 3800 * 100 / 400 = 950V$.

Example 2: Read a phase voltage UAN, read the data stored in the address 243 column to read the data, that is, the communication read out value $Val_t = 3800$, read address 13-14 voltage factor Ratio=0.25, 则 $Val_s = Val_t * Ratio = 3800 * 0.25 = 950V$.

7.5.2 Active power, reactive power, apparent power and electric energy

The series of measured values are read out by the 0X03 command of the MODBUS-RTU communication protocol, and each item occupies two words. The correspondence between the communication value and the actual one-time side value is as follows: $Val_s = Val_t / 100$; $Val_t = \text{the first word} \times 65536 + \text{the second word}$.

Applicable parameters	correspondence	unit
Power	$Val_s = Val_t * PI * PU / U_e / 10$	W、var、VA
Electric energy	$Val_s = Val_t * PI * PU / U_e / 10$	kWh、kvarh

Example 1: read A phase active power Pa, the data is stored at address 253-254: the read value of address 253 communication is 1, and the readout value of address 154 is 26000. Read $PU = 100$, $PI = 1000$, $U_e = 400$, so $Val_t = 1 \times 65536 + 26000 = 91536$, so $Val_s = Val_t * PI * PU / U_e / 10 = 2288400W$.

Example 2: read A phase active power Pa, the data is stored at address 253-254: the read value of address 253 communication is 1, and the readout value of address 154 is 26000. Read address power and electric energy coefficient of 18-19 Ratio=25, so $Val_t = 1 \times 65536 + 26000 = 91536$, so $Val_s = Val_t * Ratio = 2288400W$.

7.5.3 Voltage wave peak coefficient, telephone wave form factor, current K coefficient, voltage wave peak value, current/voltage positive sequence negative sequence, zero sequence component and unbalancedness.

This series measuring value is read out by Modbus-RTU protocol 0X03 command, each item occupies one word. Relation between communication value and actual value is shown as below table:

Applied parameter	Relation	Unit
Crest factor	$Val_s = Val_t / 1000$	None
THFF	$Val_s = Val_t / 100$	None
Current K factor	$Val_s = Val_t / 100$	None
Peak voltage(Secondary side value)	$Val_s = Val_t / 10$	V
Unbalance factor of Voltage and current	$Val_s = (Val_t / 10) \%$	Percentage

Example:Read A phase Voltage wave peak coefficient,communication reading value “Val_t” is 1414 at address 0×0119,then $Val_s = Val_t / 1000 = 1414/1000 = 1.414$

7.5.4 Voltage/current harmonic data

This series measuring value is read out by Modbus-RTU protocol 0×03 command,each item occupy one word.Relation between communication value and actual value is shown as below: $Val_s = (Val_t / 100) \%$

Example:Read current third harmonics containing rate of phase A current,communication reading value “Val_t” is 157 ,at address 0×01D0,then $Val_s = (Val_t/100) \%=1.57\%$

7.5.5 Time

This series measuring value include year,month,day,hour,minute,second,is read out by Modbus -RTU protocol 0×03 command,each item occupy one word,adopt BCD code format.

Example: Read the number of years, MODSCAN in HEX reading mode can be read directly in the address bar 0X0081

7.5.6 Event record

Event record 1- Event record 16 are recorded in chronological order, Event record 1 contains the data of latest event, Event record 16 contains the data of earliest event.The data format is as follows

	High 8-bit	Low 8-bit
Adress 1	Bit 0(The lowest bit):0 is D0,1 is DI Bit 7(The highest bit):0 is disconnected,1 is closed	Serial number of switching capacity 0 is first,1 is second and so on
Adress 2	Alarm type:See 7.1.5	Combined alarmnote
Adress 3	Year	Month
Adress 4	Day	Hour
Adress 5	Minute	Second
Adress 6	Value of the alarm(the smallest is recorded when it is open-phase)	

Note:0-Over line voltage、2-Over frequency、3-Under frequency、4-Under power、5-Over power、6-Over current、7-Under power factor、8-Over voltage unbalance、9-Over current unbalance.

Example:D01 is alarm of A phase voltage , under voltage alarm occurs in 15 January 22nd

14:56:32, the value is 172.2V, the corresponding register value is as follows:

	High 8-bit	Low 8-bit
Address 1	8	0
Address 2	1	0
Address 3	15	1
Address 4	22	14
Address 5	56	32
Address 6	1722	

8 DL/T-645 Communication Guideline

It mainly specifies how to resort to the software to control the instrument series via the communication port. The user shall have knowledge of DL/T645-1997 Communication Protocol and thoroughly read all other contents herein before a relatively comprehensive understanding on the functions and applications of the product. In the meantime, set communication port 2 as DL/T-645 Protocol. This chapter includes: DL/T645-1997 Protocol Overview, detailed explanation on the communication application format, application details and parameters address table of the instrument.

8.1 DL/T645-1997 protocol overview

This instrument conforms to DL/T645-1997 Communication Protocol. DL/T645-1997 Communication Protocol specifies in detail the calibration code, data, sequence, etc, which are indispensable to the specific data exchange. DL/T645-1997 Communication Protocol uses master-slave response connection (half duplex) in one communication line. It means bidirectional transmission along one standalone communication line. First, the host computer signal retrieves unique terminal equipment (slave), and then, the response signal sent by the terminal equipment is transmitted to the host in the opposite direction. DL/T645-1997 Protocol only allows communication between host (PC, PLC, etc) and terminal equipment instead of exchange of data in between the standalone terminal equipment. Thus, the terminal equipment will not occupy communication line during initializing. Instead, it's only limited to response to the corresponding enquiry signal.

8.2 Transmission mode

The transmission mode represents one series of independent data structure within one data frame and the limited rules for data transmission. Definitions of transmission mode compatible with DL/T645-1997 Protocol - RTU mode are as follows.

- each byte bit
- 1 initial bit
- 8 data bits; the smallest effective bit will be sent first
- 1 even calibration bit
- 1 stop bit
- Error checking and calibration

8.3 Protocol

When the data frame arrives at the terminal equipment, it resorts to one simple "port" to access the retrieved equipment. Such equipment will erase data frame "envelop" (data header) and read data. If there is no error, execute the assignment required by the data. And then, it will add the generated data into the obtained "envelop" and return the data frame to the sender. The returned response data contain contents below: terminal slave address (Address), executed command (Function), requested data (Data) generated by the execution command and one calibration code (Check). In case of any error, there won't be success response or return one error instruction frame.

9. 3. 1 Data frame format

68H	A0	A1	A2	A3	A4	A5	68H	C	L	DI0	DI1	N1	...	Nm	CS	16H
Initial symbol	Address field						Frame starting	Control code	Data length	Data label	Data				Calibration code	End symbol

a) Frame initial symbol 68H

Mark beginning of one frame of data and its value is 68H

b) Address field A0~A5

The address field is composed of 6 bytes (8 bits binary code) and each byte has 2-bit BCD code. The address length may reach 12-bit decimal number; ACR220ELH(ACR320ELH) only uses A0 and A1, thereinto, A0 represents low bytes of the address while A1 represents high bytes of the address and the formed address scope is 1~247;

the address data can be randomly set in the instrument. The remaining (A2~A5) are fully filled by 00. Such bits mark the user specified terminal equipment address and such equipment will receive the connected host data. Each terminal equipment address must be unique and only the retrieved terminal will respond to the contained address enquiry. When the terminal returns one response, the responding slave address data tell host which terminal is conducting communication. When the address is 999999999999H, it's broadcast address.

c) Control code C

The function field code tells the function to be executed by the retrieved terminal. The table below presents the function code used by the instrument series and their meanings and functions.

Code	Meaning	Action
01H	Read data	Read data from ACR220ELH/ACR320ELH
81H	Read data response	ACR220ELH/ACR320ELH response to reading data
04H	Write data	Write data into ACR220ELH/ACR320ELH
84H	Write data response	ACR220ELH/ACR320ELH response to writing data
C4H or C2H	Wrong response	Received data wrong

d) Data field (data label and data) length L

Data field byte length; read data $L \leq 200$, write data ≤ 50 , $L = 0$ means there is no data field

e) Error calibration CS

The sum of modulus 256 of all bytes starting from the frame begin symbol to calibration code, namely binary arithmetic sum of all bytes is no more than 256 overflow value.

f) symbol 16H

Indicate the end of one frame of data 9. 3. 2 Transmission

a) Lead byte

Before sending frame information, transmit 1~4 bytes FEH to awaken the receiver .

b) Transmission sequence

All data will have the low bytes sent before the high bytes. All data transmitted (except for switch volume) are the compressed BCD code of actual data plus 33H, e.g. external host reading ACR220ELH/ACR320ELH forward active electric energy meter address 1:

Host sending: FE FE 68 01 00 00 00 00 68 01 02 43 C3 DA 16

ACR220ELH/ACR320ELH response (0.40kWh) : 68 01 00 00 00 00 68 81 06 43 C3 73 33 33 33 6A 16

c) Transmission response

Each communication starts when the host station sends request command frame to the slave station determined according to the information frame address field and the requested slave station makes response according to the control code of the command frame.

Response delay after receiving order frame: $\leq 500\text{ms}$

Byte calibration is the even calibration while the frame calibration means longitudinal information calibration sum; in case of detecting even calibration or longitudinal information calibration and error, the receiver will reject the corresponding information frame without making response.

d) Error control

Byte calibration is the even calibration while the frame calibration means longitudinal information calibration sum; in case of detecting even calibration or longitudinal information calibration and error, the receiver will reject the corresponding information frame without making response.

e) Transmission speed

Initial speed: 9600bps

Set as: 1200, 2400, 4800, 9600, 19200bps

Data label table

Table 1

S/N	Variables	Send example (take broadcast address as an example, the user may conduct setting according to actual demand, address high bit filled by "00000000")	Return bytes	Return data format (secondary side)	返回数据单位
1	Forward active electric energy	68 99 99 99 99 99 99 68 01 02 43 C3 6F 16	4	XXXXXX. XX	kWh
2	Backward active electric energy	68 99 99 99 99 99 99 68 01 02 53 C3 7F 16	4	XXXXXX. XX	kWh
3	Forward passive	68 99 99 99 99 99 99 68 01 02 43 C4 70 16	4	XXXXXX. XX	kvarh

	electric energy				
4	Backward passive electric energy	68 99 99 99 99 99 99 68 01 02 53 C4 80 16	4	XXXXXX. XX	kvarh
5	Phase A voltage	68 99 99 99 99 99 99 68 01 02 44 E9 96 16	2	XXX	V
6	Phase B voltage	68 99 99 99 99 99 99 68 01 02 45 E9 97 16	2	XXX	V
7	Phase C voltage	68 99 99 99 99 99 99 68 01 02 46 E9 98 16	2	XXX	V
8	Phase A harmonic voltage	68 99 99 99 99 99 99 68 01 02 47 E9 99 16	2	XXX	V
9	Phase B harmonic voltage	68 99 99 99 99 99 99 68 01 02 48 E9 9A 16	2	XXX	V
10	Phase C harmonic voltage	68 99 99 99 99 99 99 68 01 02 49 E9 9B 16	2	XXX	V
11	Voltage vector sum	68 99 99 99 99 99 99 68 01 02 4A E9 9C 16	2	XXX	V
12	Power grid frequency	68 99 99 99 99 99 99 68 01 02 4B E9 9D 16	2	XX. XX	Hz
13	Phase A current	68 99 99 99 99 99 99 68 01 02 54 E9 A6 16	2	XX. XX	A
14	Phase B current	68 99 99 99 99 99 99 68 01 02 55 E9 A7 16	2	XX. XX	A
15	Phase C current	68 99 99 99 99 99 99 68 01 02 56 E9 A8 16	2	XX. XX	A
16	Phase A harmonic current	68 99 99 99 99 99 99 68 01 02 57 E9 A9 16	2	XX. XX	A
17	Phase B harmonic current	68 99 99 99 99 99 99 68 01 02 58 E9 AA 16	2	XX. XX	A
18	Phase C harmonic current	68 99 99 99 99 99 99 68 01 02 59 E9 AB 16	2	XX. XX	A
19	Current vector sum	68 99 99 99 99 99 99 68 0102 5A E9 AC 16	2	XX. XX	A
20	Conjunction active power	68 99 99 99 99 99 99 68 01 02 63 E9 B5 16	3	XX. XXXX	kW
21	Phase A active power	68 99 99 99 99 99 99 68 01 02 64 E9 B6 16	3	XX. XXXX	kW
22	Phase B active power	68 99 99 99 99 99 99 68 01 02 65 E9 B7 16	3	XX. XXXX	kW
23	Phase C active power	68 99 99 99 99 99 99 68 01 02 66 E9 B8 16	3	XX. XXXX	kW
24	Conjunction reactive power	68 99 99 99 99 99 99 68 01 02 73 E9 C5 16	2	XX. XX	kvar
25	Phase A reactive power	68 99 99 99 99 99 99 68 01 02 74 E9 C6 16	2	XX. XX	kvar

	power				
26	Phase B reactive power	68 99 99 99 99 99 99 68 01 02 75 E9 C7 16	2	XX. XX	kvar
27	Phase C reactive power	68 99 99 99 99 99 99 68 01 02 76 E9 C8 16	2	XX. XX	kvar
28	Conjunction power factor	68 99 99 99 99 99 99 68 01 02 83 E9 D5 16	2	X. XXX	
29	Phase A power factor	68 99 99 99 99 99 99 68 01 02 84 E9 D6 16	2	X. XXX	
30	Phase B power factor	68 99 99 99 99 99 99 68 01 02 85 E9 D7 16	2	X. XXX	
31	Phase C power factor	68 99 99 99 99 99 99 68 01 02 86 E9 D8 16	2	X. XXX	
32	Reading date	68 99 99 99 99 99 99 68 01 02 43 F3 9F 16	4	YYMMDDWW	WW=00
33	Reading time	68 99 99 99 99 99 99 68 01 02 44 F3 A0 16	3	hhmmss	
34	Switch state value	68 99 99 99 99 99 99 68 01 02 56 F3 B2 16	1		See attachment 1
35	Voltage rate	68 99 99 99 99 99 99 68 01 02 68 F3 C4 16	2	XXXX	
36	Current rate	68 99 99 99 99 99 99 68 01 02 69 F3 C5 16	2	XXXX	
37	Switch output	68 99 99 99 99 99 99 68 04 03 56 F3 00 B6 16	0		The total switch volume output has 4 ways:: DO1-D04
38	Set DO1	68 99 99 99 99 99 99 68 04 03 56 F3 01 B7 16	0		
39	Set DO2	68 99 99 99 99 99 99 68 04 03 56 F3 02 B8 16	0		
40	Set DO1, DO2	68 99 99 99 99 99 99 68 04 03 56 F3 03 B9 16	0		

Attachment 1:

Bit7	Bit6	Bit5	Bit4	Bit3	Bit2	Bit1	Bit0
DI1	DI2	DI3	DI4	D01	D02	D03	D04

Headquarter: Acrel Electrical Equipment Co., Ltd.

Address: No. 253, Yulv Road, Madong Industrial Park Zone, Jiading District, Shanghai City.

Tel: (86) 021-69158300 69158301 69158302

Fax: (86) 021-69158303

Service hotline: 800-820-6632

URL: www.acrel.cn

E-mail: ACREL001@vip.163.com

Zip code: 201801

Production base: Jiangsu Acrel Electrical Equipment Manufacturing Co., Ltd.

Address: No. 5, Dongmeng Road, Dongmeng Industrial Park Zone, Nanzha Town, Jiangyin City.

Tel (Fax): (86) 0510-86179970

Zip code: 214405

E-mail: JY-ACREL001@vip.163.com

Change record:

V1.3: 1、The communication address 14-15 increases the voltage coefficient, 16-17 increases the current coefficient, 18-19 increases the power and electric energy coefficient, and all of them are FLOAT, The secondary side value in the communication is multiplied by the corresponding coefficient equal to the first time;

2、The parameter of voltage coefficient in 7.5.1 case 2 is modified to 0.25.

3、Revise the power and electric energy coefficient in 7.5.2 example 2 to 25.

V1.4: Delete the “comprehensive” and comprehensive power monitoring and assessment management” in the overview.

V1.5: 1、Delete the grounding single on the secondary side in 5.4.

2、Change the three-core shield line in 7 to the two-core shield line.